

# REPAIR MANUAL 2005-2010



**WP FORK**  
**4860 MXMA**  
**CLOSED CARTRIDGE**

REPARATURANLEITUNG

MANUALE DI RIPARAZIONE

MANUEL DE RÉPARATION

MANUAL DE REPARACIÓN

ART.NR.: 3211.199-E

*suspension*  
**WP**



# **1 SPECIAL TOOLS**

---

## **2 GENERAL INFORMATION**

---

### **3 DISMOUNTING/MOUNTING THE FORK**

---

#### **4 DISASSEMBLING AND ASSEMBLING THE FORK**

---

**5**

---

**6**

---

**7**

---

**8**

---

**9**

---

**10**

---

**11**

---

**12**

---

**13**

---

**14**

---

**15**

---

**16**

---



## INTRODUCTION

This repair manual offers extensive repair-instructions and is an up-to-date version that describes the latest models of the series. However, the right to modifications in the interest of technical improvement is reserved without updating the current issue of this manual.

A description of general working modes common in work shops has not been included. Safety rules common in the work shop have also not been listed. We take it for granted that the repairs are made by qualified professionally trained mechanics.

Read through the repair manual before beginning with the repair work.

---

**⚠                      WARNING                      ⚠**

---

**STRICT COMPLIANCE WITH THESE INSTRUCTIONS IS  
ESSENTIAL TO AVOID DANGER TO LIFE AND LIMB.**

---

**!                      CAUTION                      !**

---

**NON-COMPLIANCE WITH THESE INSTRUCTIONS CAN LEAD TO  
DAMAGE OF MOTORCYCLE COMPONENTS OR RENDER MOTORCYCLES  
UNFIT FOR TRAFFIC !**

**„NOTE” POINTS OUT USEFUL TIPS.**

Use only **ORIGINAL KTM/WP SPARE PARTS** when replacing parts.

The KTM high performance fork is only able to meet user expectations if the maintenance work is performed regularly and professionally.



REG.NO. 12 100 6061

In accordance with the international quality management ISO 9001 standard, KTM uses quality assurance processes that lead to the highest possible product quality.

KTM Sportmotorcycle AG reserves the right to modify any equipment, technical specifications, colors, materials, services offered and rendered, and the like so as to adapt them to local conditions without previous announcement and without giving reasons, or to cancel any of the above items without substituting them with others. It shall be acceptable to stop manufacturing a certain model without previous announcement. In the event of such modifications, please ask your local KTM dealer for information.

KTM Sportmotorcycle AG  
5230 Mattighofen, Austria

All design and assembly modification rights reserved.

© by KTM SPORTMOTORCYCLE AG, AUSTRIA      All rights reserved



# REPLY FAX FOR REPAIR MANUALS

We have made every effort to make our repair manuals as accurate as possible but it is always possible for a mistake or two to creep in.

To keep improving the quality of our repair manuals, we request mechanics and shop foremen to assist us as follows:

If you find any errors or inaccuracies in one of our repair manual – whether these are technical errors, incorrect or unclear repair procedures, tool problems, missing technical data or torques, inaccurate or incorrect translations or wording, etc. – please enter the error(s) in the table below and fax the completed form to us at 0043/7742/6000/5349.

NOTE to table:

- Enter the complete item no. for the repair manual in column 1 (e.g.: **3.211.199-E**).  
You will find the number on the cover page or in the left margin on each right page of the manual.
- Enter the corresponding page number in the repair manual (e.g.: **4-7**) in column 2.
- Enter the current text (inaccurate or incomplete) in column 3 by quoting or describing the respective passage of the text. If your text deviates from the text contained in the repair manual, please write your text in German or English if possible.
- Enter the correct text in column 4.

Your corrections will be reviewed and incorporated in the next issue of our repair manual.

Item no. of repair manual	Page	Current text	Correct text

Additional suggestions, requests or comments on our Repair Manuals (in German or English):

---

---

---

---

---

---

---

---

Name mechanic/shop foreman

Company/work shop





# SPECIAL TOOLS

1

## INDEX

T 103 PIN SPANNER .....	1-2
T 131 LOCTITE 243 .....	1-2
T 132 LOCTITE 2701 .....	1-2
T 137S SQUEEZE BOTTLE .....	1-2
T 158 O-RING GREASE .....	1-2
T 159 WATER PROOF GREASE .....	1-3
T 511 GREASE FOR SEALS .....	1-3
T 605 PIN .....	1-3
T 1240S VACUUM FILLING DEVICE .....	1-3
T 1401 SEAL ASSEMBLING TOOL .....	1-3
T 1402S ASSEMBLING TOOL SEAL AND DU-BUSH .....	1-4
T 1403S CLAMPING-BLOCK 48/60 .....	1-4
T 1404 PIN SPANNER INNER-TUBE .....	1-4
T 14.015S CLAMPING BLOCK 27 .....	1-4
T 14.016S CLAMPING BLOCK 12 .....	1-4
T 14.017 SPANNER 50 .....	1-5
T 14.018 SPANNER SCREW-CAP MEMBRANE HOLDER .....	1-5
T 14.019 CHARGING DEVICE TOOL .....	1-5
T 14.020 SUPPORT TOOL DIS- / ASSEMBLING CLOSED CARTRIDGE .....	1-5
T 14.021 CALIBRATE MANDREL DU-BUSH 12 .....	1-5
T 14.022 DIS- / ASSEMBLING TOOL DU-BUSH 12 .....	1-6
T 14.023 THREADED BUSH .....	1-6
T 14.024 SUPPORT BUSH .....	1-6
T 14.025 ASSEMBLING TOOL OIL SEAL SCREW SLEEVE .....	1-6
T 14.029 MOUNTING BUSH .....	1-6
T 14.030 ADAPTOR .....	1-7
T 14.033 ASSEMBLING TOOL .....	1-7





**T 103**  
Pin spanner



**T 131**  
Loctite 243



**T 132**  
Loctite 2701



**T 137S**  
Squeeze bottle



**T 158**  
O-Ring grease



**T 159**  
Water proof grease



**T 511**  
Grease for seals



**T 605**  
Pin



**T 1240S**  
Vacuum filling device

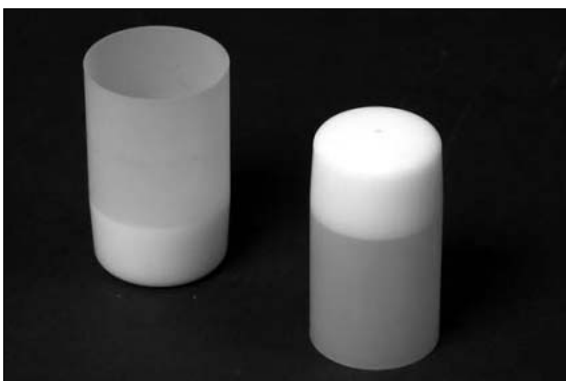

**T 1401**  
Assembling tool for seal

**T 1402S**

Assembling tool seal and DU-bush

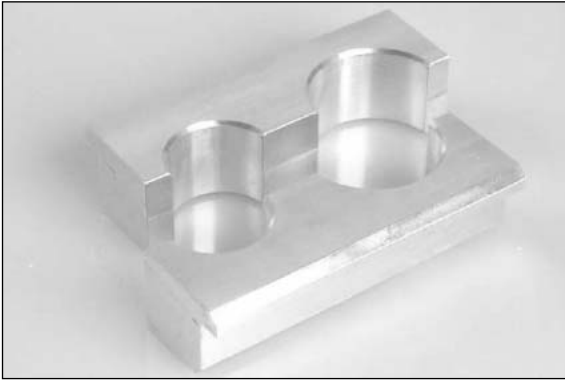
**T 1403S**

Clamping-block 48/60

**T 1404**

Pin spanner inner-tube

**T 14.015S**

Clamping block 27

**T 14.016S**

Clamping block 12



**T 14.017**  
Spanner 50



**T 14.018**  
Spanner screw-cap membrane holder



**T 14.019**  
Charging device tool

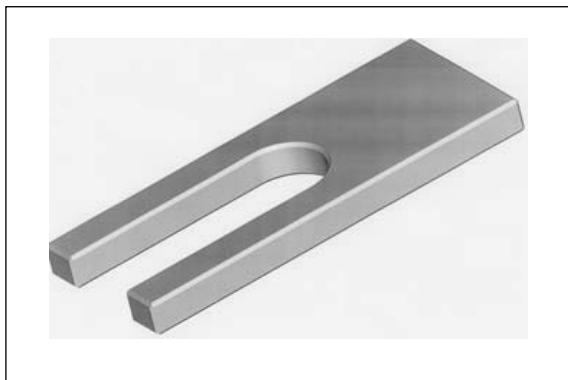

**T 14.020**  
Support tool dis-/assembling closed cartridge.

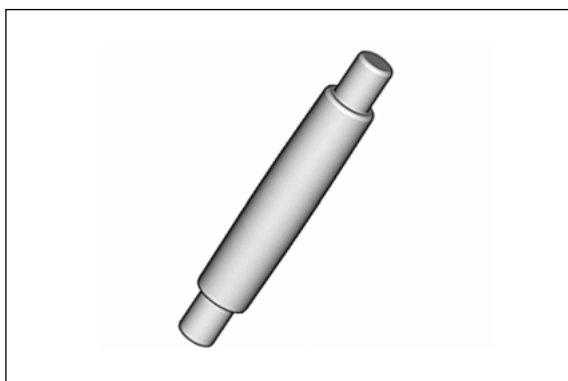

**T 14.021**  
Calibrate mandrel DU-bush

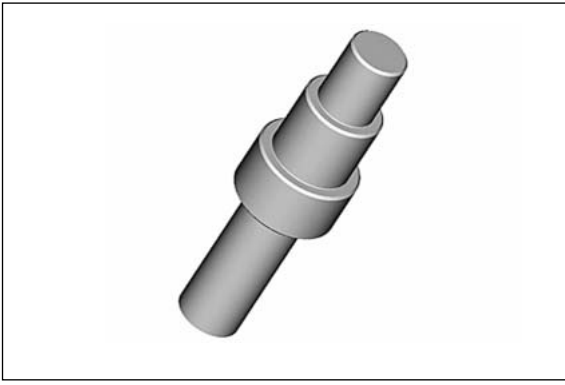

**T 14.022**  
Dis-/assembling tool DU-bush

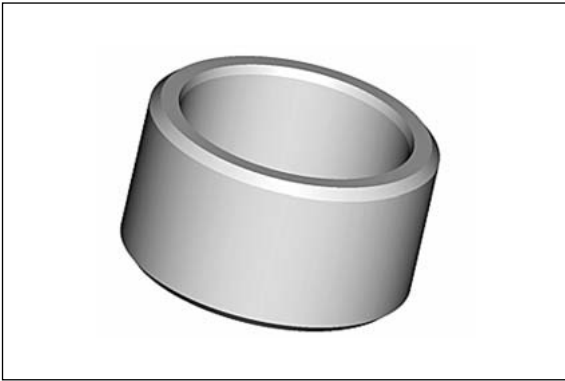

**T 14.023**  
Threaded bush

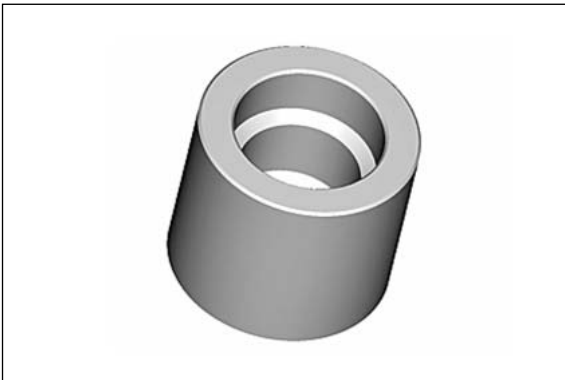

**T 14.024**  
Support bush

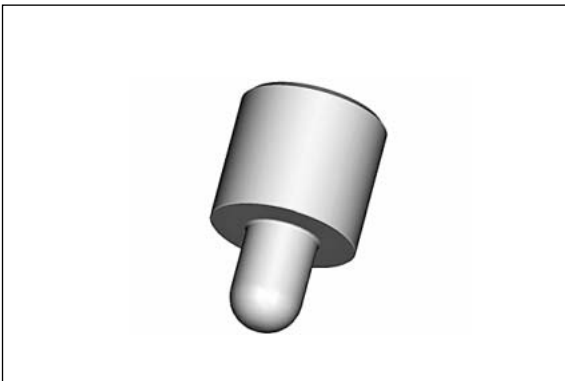

**T 14.025**  
Assembling tool oil seal screw sleeve



**T 14.029**  
Mounting bush



**T 14.030**  
Adaptor

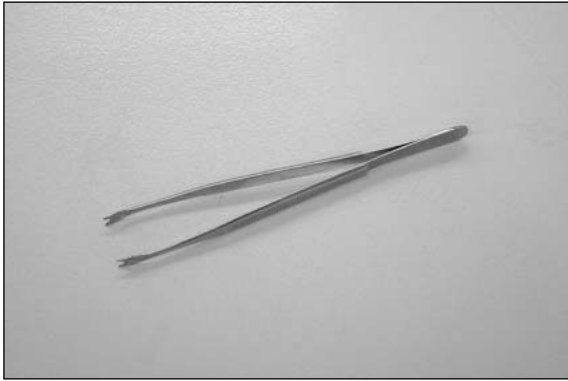

**T 14.033**  
Assembling tool



# GENERAL INFORMATION

# 2

## INDEX

<b>EXPLODED VIEW SXS 2005</b> .....	<b>2-2</b>
<b>PART LIST SXS 2005</b> .....	<b>2-3</b>
<b>EXPLODED VIEW SXS 2006</b> .....	<b>2-4</b>
<b>PART LIST SXS 2006</b> .....	<b>2-5</b>
<b>EXPLODED VIEW SX 2007</b> .....	<b>2-6</b>
<b>PART LIST SX 2007</b> .....	<b>2-7</b>
<b>EXPLODED VIEW SXS 2007</b> .....	<b>2-8</b>
<b>PART LIST SXS 2007</b> .....	<b>2-9</b>
<b>ADJUSTMENTS</b> .....	<b>2-10</b>
<b>ADJUSTING THE POSITION OF THE COMPRESSION AND REBOUND DAMPING</b> ..	<b>2-10</b>
<b>EXPLANATION OF THE SPRING PRELOAD</b> .....	<b>2-11</b>
<b>BLEEDER SCREW</b> .....	<b>2-12</b>
<b>RECOMMENDED PERIODICAL MAINTENANCE INTERVALS</b> .....	<b>2-12</b>



Exploded view SXS 2005

Art.No.: 3.211.199-E

Repair manual WP Fork "Closed Cartridge"

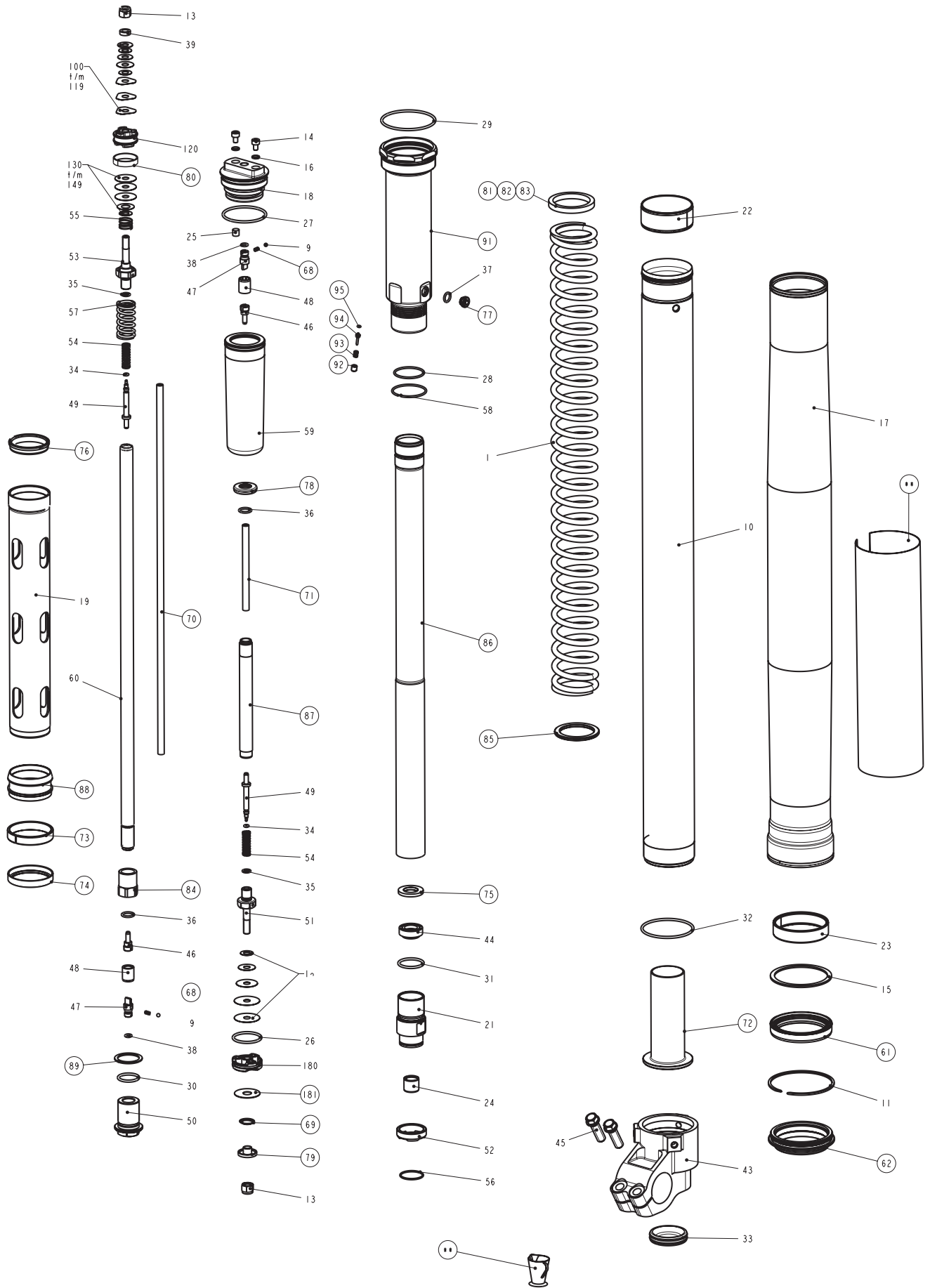

## Part list SXS 2005

Pos.	Part description	Art. No.	Pcs
9	Ball-steel d3	4054.0603.	2
10	Inner-tube SXS'05 d48 L595 Ti	4860.0439.	1
11	Lock washer SB58	4860.0070.	1
13	Lock nut M6x1	4860.0441.	2
14	Cil.head screw	4860.0443.	2
15	Support ring d50xd57.6x1.5	4860.0013.	1
16	Oil seal washer d4	4860.0440.	2
17	Outer-tube 54/60 L577	4860.0244	1
18	Screw cap	4860.0284.	1
19	Tube d35xD 37.5	4860.0468.	1
21	Screw sleeve M24.5x1	4860.0470.	1
22	DU-bush d47xd49x20 DDL02	4860.0428.	1
23	DU-bush d48xd52x12 DDL02	4860.0429.	1
24	DU-bush d14xd12x10 DDL02	4860.0430.	1
25	Rubber plug	1508.0017.	1
26	O-ring N.B.R. 24x2	3548.0320.	1
27	O-ring N.B.R. 38x2	4054.0037.	1
28	O-ring N.B.R. 261.5	4054.0230.	1
29	O-ring N.B.R. 48x2	4681.0016.	1
30	O-ring N.B.R. 17x2	4681.0811.	1
31	O-ring N.B.R. 21x2	4681.1499.	1
32	O-ring N.B.R. 46x2	4860.0048.	1
33	Rubber cap	4860.0141.	1
34	O-ring N.B.R. 2x1.5	4860.0298.	2
35	O-ring N.B.R. 6x1.2	4860.0299.	2
36	O-ring N.B.R. 9.5x1.5	4860.0301.	2
37	O-ring Viton 7x1.5	5018.0157.	1
38	O-ring N.B.R. 4x1.5	5018.0222.	2
39	Bush d10x3	4054.0497.	1
42	Axle-clamp Ma brake KTM SXR "03	4860.0465.	1
43	Axle-clamp MA ri KTM SXR "03	4860.0466.	1
44	Oil seal d12xd22x9.5	4860.0471.	1
45	Bolt with flange M 8x25	5060.0113.	2
46	Holder adj. tube d4 L=18	4860.0271.	2
47	Adj. screw 1.8	4860.0272.	2
48	Retainer Ring d10.8	4860.0273.	2
49	Needle bleed adj.	4860.0277.	2
50	Bolt M20x1 L33	4860.0280.	1
51	Tap compression d2.5 '03	4860.0282.	1
52	Check valve ring	4860.0297.	1
53	Piston rod tap rebound	4860.0450.	1
54	Spring rebound adj. C=4N/mm	4860.0444.	2
55	Shuttle valve spring C0.4 Lo=8	4860.0382.	1
56	Lock washer d20	4860.0446.	1
57	Rebound spring L33.5 d=13 c=11	4860.0447.	1
58	Lock washer d30	4860.0448.	1
59	Membrane CC	4860.0281.	1
60	Piston rod d12 M9x1 L405	4860.0464.	1
61	Oil seal d48xd57.8x9.5 '03	4860.0347.	1
62	Dust stripper d48 d58.4 x11.8	4860.0400.	1
68	Spring d2.9 L6.5	4860.0490.	2
69	Check valve spring th 0.7	4860.0202.	1
70	Adj. Tube L=371	4860.0269.	1
71	Adj. tube L=85	4860.0274.	1
72	Hydr.stop d28	4860.0286.	1
73	Guiding ring D44.2xs39.3	4860.0294.	1
74	Ring D42.4x6.5	4860.0295.	1
75	Ring D23.45x2.65	4860.0296.	1
76	Support ring D37.5	4860.0304.	1
77	Plug G1/8	4860.0452.	1
78	Clamping disc	4860.0453.	1
79	Check valve holder L=7	4860.0454.	1
80	Piston ring 5x1x68	4860.0455.	1
81	Spacer 43x35x2.5	4860.0456.	1
82	Spacer 43x35x5	4860.0457.	1
83	Spacer 43x35x1.5	4860.0458.	1
84	Contra nut M12x1 SLW17	4860.0459.	1
85	Washer 32x42x2.5	4860.0460.	1
86	Tube d23 L417 CC	4860.0461.	1
87	Piston rod d12 L117	4860.0462.	1
88	Adaptor guiding bush	4860.0463.	1
89	Washer copper 20.5x26x1	4860.0275.	1
91	Membrane holder cpl.	4860.0476.	1
92	Adj.screw M5	4860.0472.	1
93	Spring d=3.9 C=1.1N/mm Lo=8mm	4860.0473.	1
94	Pin valve	4860.0474.	1
95	O-ring Viton 1.5 x 1	4681.1351.	1
120	Piston rebound bleed 1.2	4860.0489.	1
180	Piston compression	4860.0047.	1

Exploded view SXS 2006

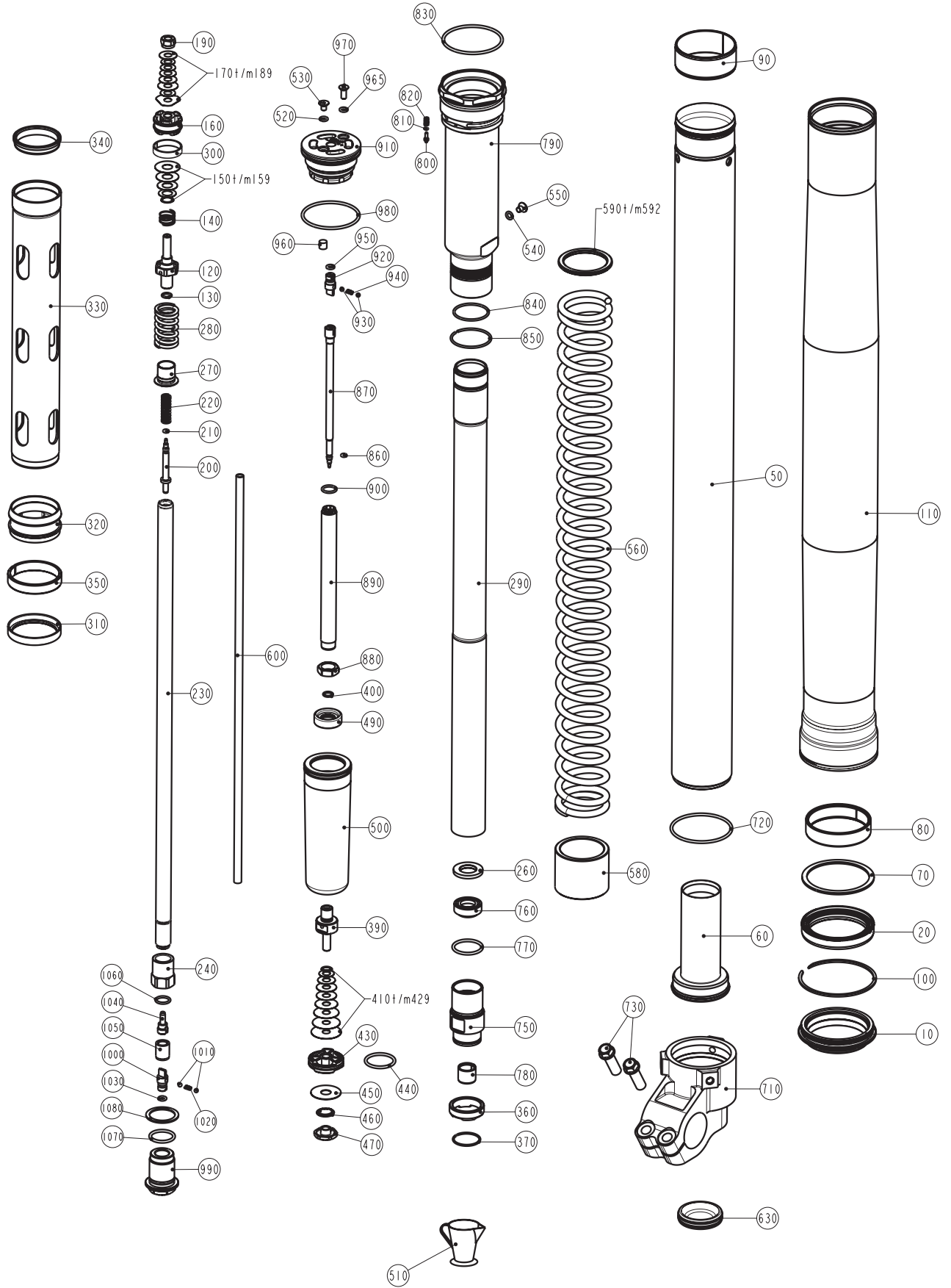

Art.No.: 3.211.199-E

Repair manual WP Fork "Closed Cartridge"

## Part list SXS 2006

Pos.	Part description	Part number	Pieces
10	Dust stripper	4860.0400	1
20	Oil seal	4860.0347	1
50	Inner-tube	4860.0550	1
60	Hydr.stop	4860.0521	1
70	Support ring	4860.0013	1
80	DU-bush	4860.0429	1
90	DU-bush	4860.0428	1
100	Lock washer	4860.0070	1
110	Outer-tube	4860.0539E	1
120	Check valve ring	4860.0513	1
130	O-ring	4860.0299	1
140	Shuttle valve spring	4860.0382	1
160	Piston rebound bleed	4860.0489	1
190	Lock nut	4054.0486	1
200	Needle bleed adj.	4860.0277	1
210	O-ring	4860.0298	1
220	Spring rebound adj.	4860.0444	1
230	Piston rod	4860.0531	1
240	Contra nut	4860.0459	1
260	Ring	4860.0296	1
270	Spring guide	4860.0525	1
280	Rebound spring	4860.0511	1
290	Tube	4860.0461	1
300	Piston ring	4860.0455	1
310	Ring	4860.0295	1
320	Adaptor guiding bush	4860.0463	1
330	Tube	4860.0468	1
340	Support ring	4860.0304	1
350	Guiding ring	4860.0294	1
360	Cap	4860.0297	1
370	Lock washer	4860.0446	1
390	Tap compression	4860.0509	1
400	O-Ring	4860.0299	1
410	Shim	4054.0414	1
430	Piston compression	4860.0047	1
440	O-ring	4681.1499	1
450	Check valve	4860.0061	1
460	Check valve spring	4860.0202	1
470	Check valve holder	4860.0163	1
490	Clamping disc	4860.0514	1
500	Membrane	4860.0281	1
510	Fork oil	4860.0401	0,5
520	Oil seal washer	5018.0222	1
530	Bleeder screw	4860.0527	1
540	O-ring	5018.0222	1
550	Plug	4860.0542	1
560	Spring	9141.0052	1
580	Washer	4860.0552	1
590	Spacer	4860.0456	1
600	Adj.tube	4860.0533	1
630	Rubber cap	4860.0141	1
710	Axle-clamp	4860.0545	1
720	O-ring	4860.0048	1
750	Screw sleeve	4860.0546	1
760	Oil seal	4860.0471	1
770	O-ring	4681.1499	1
780	DU-bush	4860.0430	1
790	Membrane holder cpl.	4860.0548	1
800	Bolt	4860.0518	1
810	O-ring	4860.0541	1
820	Spring	4860.0540	1
830	O-ring	4681.0340	1
840	O-ring	4054.0230	1
850	Lock washer	4860.0448	1
860	O-ring	4860.0298	1
870	Needle bleed adj.	4860.0506	1
880	Lock nut	4860.0276	1
890	Piston rod	4860.0516	1
900	O-Ring	4860.0301	1
910	Screw cap	4860.0532	1
920	Adj. screw	4860.0523	1
930	Ball-steel	4054.0603	2
940	Spring	4860.0522	1
950	O-ring	5018.0222	1
960	Rubber plug	1508.0017	1
965	Oil seal washer	5018.0222	1
970	Cil.head screw	4860.0526	1
980	O-ring	4014.0024	1
990	Bolt	4860.0280	1
1000	Adj. screw	4860.0523	1
1010	Ball-steel	4054.0603	2
1020	Spring	4860.0522	1
1030	O-ring	5018.0222	1
1040	Holder adj. tube	4860.0271	1
1050	Retainer ring	4860.0273	1
1060	O-ring	4860.0301	1
1070	O-ring	4681.0811	1
1080	Washer copper	4860.0275	1

### Exploded view SX 2007

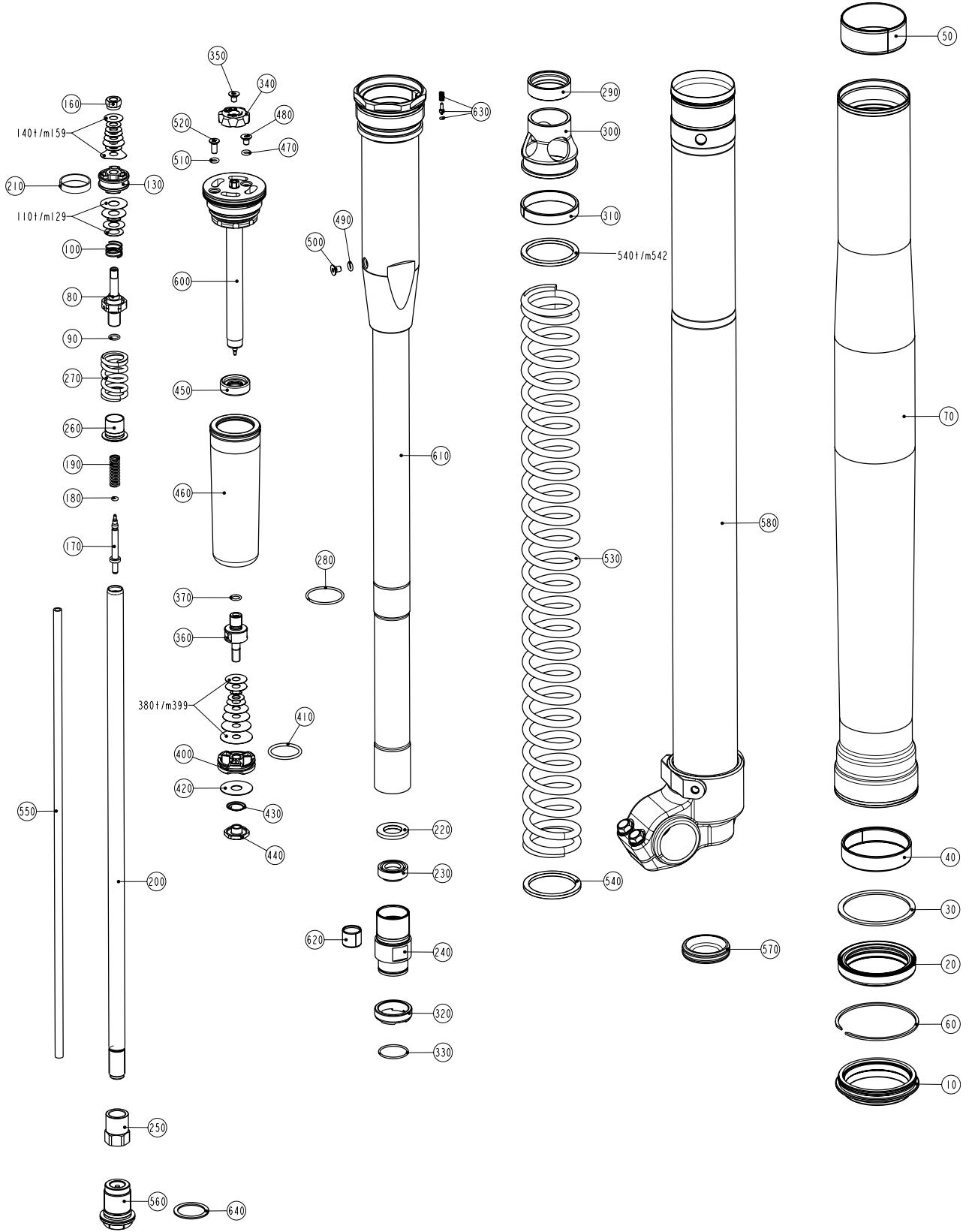

Art.No.: 3.211.199-E

Repair manual WP Fork "Closed Cartridge"

## Part list SX 2007

Pos.	Part description	Part number	Pieces
10	Dust stripper	4860.0400	1
20	Oil seal	4860.0399	1
30	Support ring	4860.0013	1
40	DU-bush	4860.0429	1
50	DU-bush	4860.0428	1
60	Lock washer	4860.0070	1
70	Outer-tube	4860.0492E	1
80	Rebound support	4860.0576	1
90	O-ring	4860.0299	1
100	Shuttle valve spring	3548.0377	1
130	Piston rebound	4860.0575	1
160	Nut	4054.0486	1
170	Needle for rebound adjustment	4860.0277	1
180	O-ring	4860.0298	1
190	Spring for rebound adjustment	4860.0444	1
200	Piston rod	4860.0464	1
210	Piston ring	4860.0455	1
220	Ring	4860.0296	1
230	Oil seal	4860.0471	1
240	Screw sleeve	4860.0546S	1
250	Lock nut	4860.0459	1
260	Spring guide	4860.0525	1
270	Rebound spring	4860.0511	1
280	Lock washer	4860.0512	1
290	Support ring	4860.0577	1
300	Guiding ring adapter	4860.0520	1
310	Guiding ring	4860.0294	1
320	Check valve ring	4860.0297	1
330	Lock washer	4860.0446	1
340	Control knob for compression	4860.0569	1
350	Screw	4860.0527	1
360	Tap compression	4860.0509	1
390	O-ring	4860.0299	1
400	Piston compression	4860.0047	1
410	O-ring	4681.1499	1
430	Check valve spring	4860.0202	1
440	Check valve holder	4860.0163	1
450	Clamping disc	4860.0514	1
460	Membrane	4860.0281	1
470	O-ring	5018.0222	1
480	Screw	4860.0527	1
490	O-ring	5018.0222	1
500	Screw	4860.0542	1
510	O-ring	5018.0222	1
520	Screw	4860.0526	1
530	Spring	9141.0052	1
540	Spacer	4860.0456	1
541	Spacer	4860.0457	1
542	Spacer	4860.0458	1
550	Adj.tube	4860.0269	1
560	Bolt	4860.0280	1
570	Rubber cap	4860.0141	1
580	Inner-tube	4860.0530S1	1
600	Piston rod	4860.0516S1	1
610	Membrane holder cpl.	4860.0519S1	1
620	DU-bush	4860.0430	1
630	Check valve, complete	4860.0518S	1



### Exploded view Fork SXS 2007

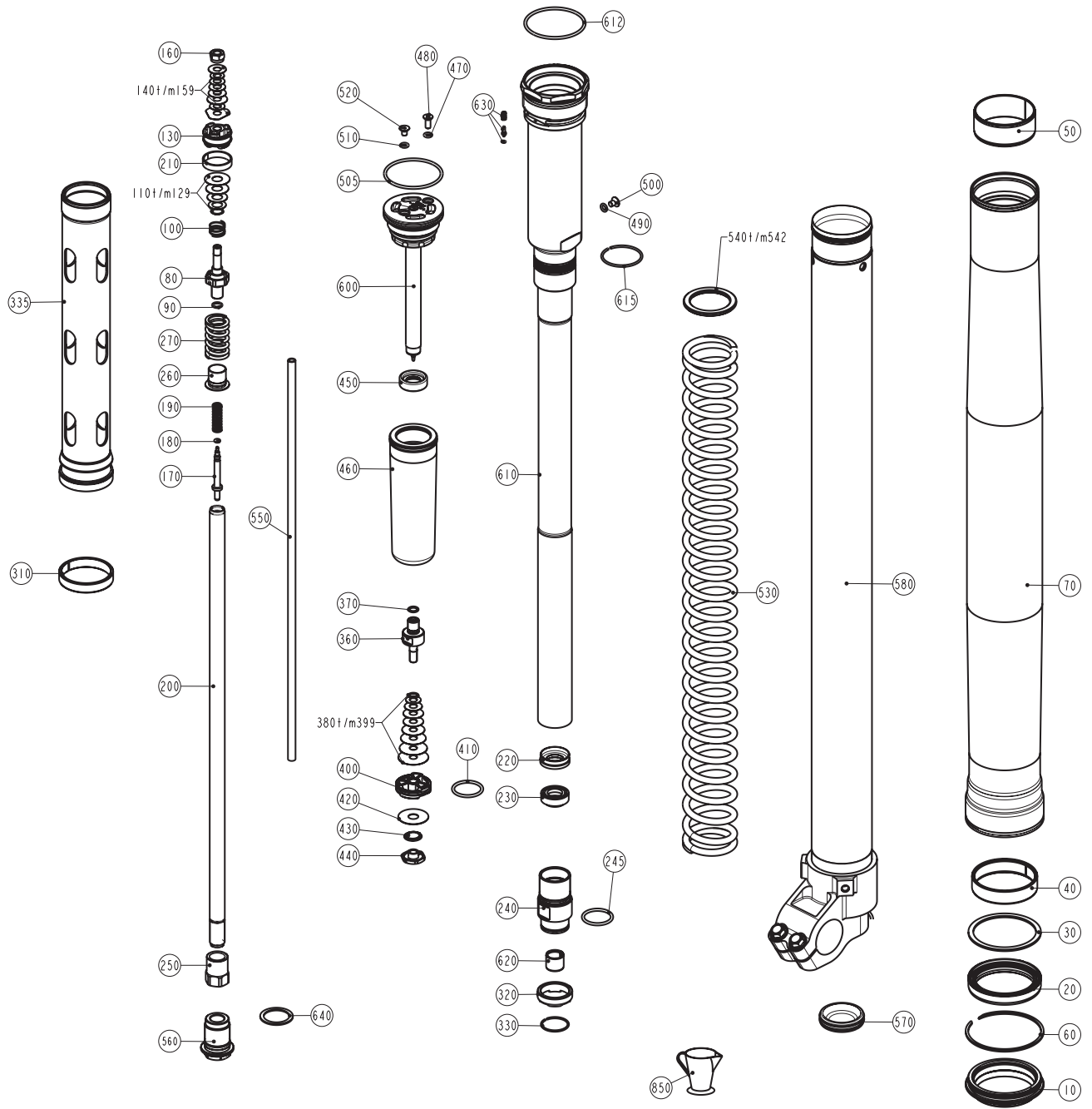

Art.No.: 3.211.199-E

Repair manual WP Fork "Closed Cartridge"

## Part list Fork SXS 2007

Pos.	Part description	Part number	Pieces
10	Dust stripper	4860.0400	1
20	Oil seal	4860.0347	1
30	Support ring	4860.0013	1
40	DU-bush	4860.0429	1
50	DU-bush	4860.0428	1
60	Lock washer	4860.0070	1
70	Outer-tube	4860.0684	1
80	Piston rod tap rebound	4860.0576	1
90	O-ring	4860.0299	1
100	Shuttle valve spring	4860.0382	1
130	Piston rebound bleed	4860.0679	1
160	Lock nut	4054.0486	1
170	Needle bleed adj.	4860.0277	1
180	O-ring	4860.0298	1
190	Piston rebound bleed	4860.0444	1
200	Piston rod	4860.0464	1
210	Piston ring	4860.0455	1
220	Ring	4860.0296	1
230	Oil seal	4860.0471	1
240	Screw sleeve	4860.0546S	1
245	O-ring	4681.1499	1
250	Contra nut	4860.0459	1
260	Spring guide	4860.0525	1
270	Rebound spring	4860.0578	1
310	Ring	4860.0294	1
320	Cap	4860.0297	1
335	Tube	4860.0468S	1
360	Tap compression	4860.0509	1
370	O-ring	4860.0299	1
400	Piston compression	4860.0047	1
410	O-ring	4681.1499	1
420	Check valve	4860.0061	1
430	Check valve spring	4860.0202	1
440	Check valve holder	4860.0163	1
450	Clamping disc	4860.0514	1
460	Membrane	4860.0281	1
470	Oil seal washer	5018.0222	1
480	Cil.head screw	4860.0527	1
490	O-ring	5018.0222	1
500	Plug	4860.0542	1
505	O-ring	4014.0024	1
510	Oil seal washer	5018.0222	1
520	Bleeder screw	4860.0526	1
530	Spring	9141.0052	1
540	Spacer 43x35x2.5	4860.0456	?
541	Spacer 43x35x5	4860.0457	?
542	Spacer 43x35x1.5	4860.0458	?
550	Adj.tube	4860.0269	1
560	Bolt	4860.0280S	1
570	Rubber cap	4860.0141	1
580	Inner-tube right	4860.0676S1	1
580	Inner-tube left	4860.0675S1	1
600	Screw cap	4860.0516S1	1
610	Membrane holder cpl.	4860.0605S1	1
612	O-ring	4860.0340	1
615	Lock washer	4860.0448	1
620	DU-bush	4860.0430	1
630	Screw, O-ring, spring cpl.	4860.0518S	1
640	O-ring	4860.0275	1
850	Fork oil	4860.0401	0.4

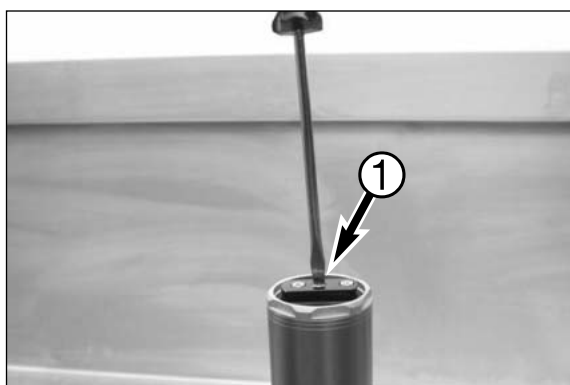

### Adjustments

- Take notice of the position of the compression adjustment ❶!
- Count the amount of clicks by turning the adjustment screw clockwise till fully closed.



- Remove the rubber cap out of the axleclamp.

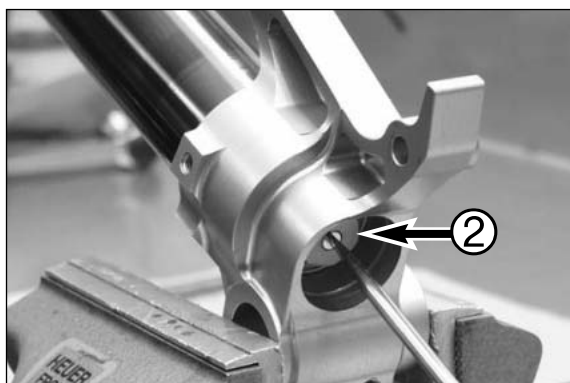

- Take notice of the position of the rebound adjustment ❷!
- Count the amount of clicks by turning the adjustment screw clockwise till fully closed.
- For the standard position see setting list.

### Position of the compression and rebound adjustment

- Set the rebound position ❶, see KTM-Owners manual.
- Assemble the rubber cap.
- Set the compression position ❷, see KTM-Owners manual.

**Explanation of the spring preload**

– Total spring length without the spacers, see chapter inspection of the spring!

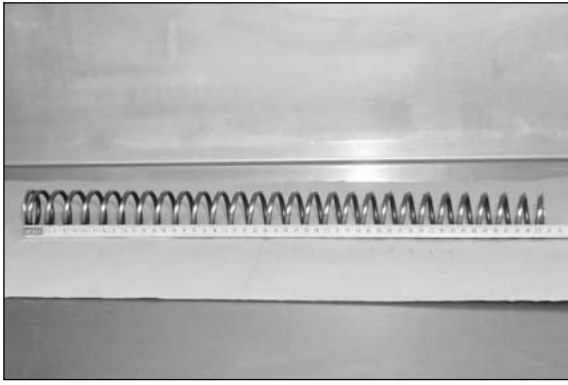

– Spring length with spacers ❶, see setting list.

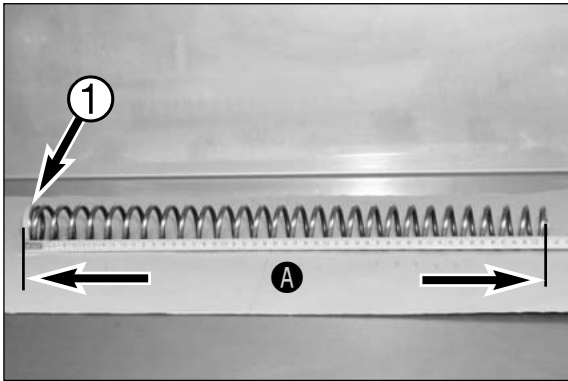

– Spring with the spacers. ❶.

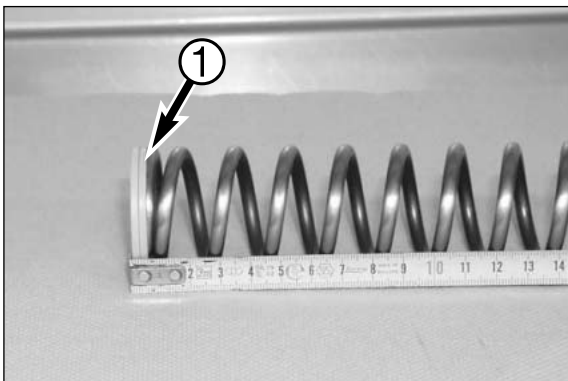

– The spring is assembled in the front fork leg.

NOTE: the distance of “B” is less then the length of “A”.

$$\frac{A}{- B}$$

= Spring preload

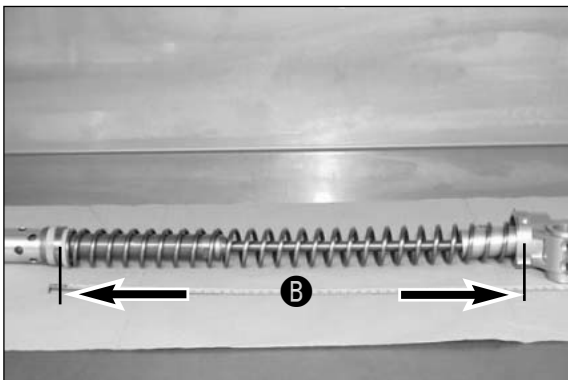



### Air release screw

- Place the motorcycle on the stand.

NOTE: the front wheel must be lift of the floor!

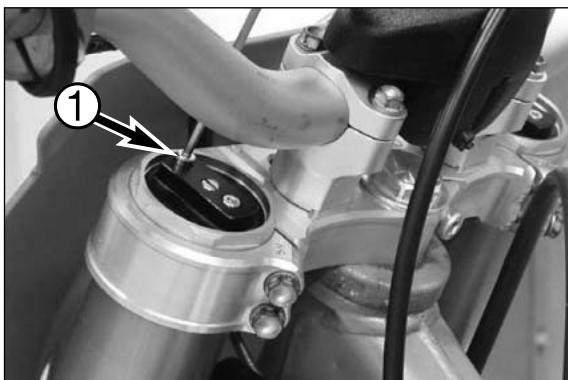

- Unscrew the air release screw ① of the screw cap on top of the front fork and tighten after approx. 10 seconds the air release screw.

### Recommended periodic maintenance and inspection of the 4860 SX/SXS/SMR front fork

A 100 liter fuel consumption is equivalent to approx. 15 operating hours	10 hours 65 liter	20 hours 130 liter	30 hours 200 liter	40 hours 260 liter	50 hours 325 liter	60 hours 400 liter	70 hours 455 liter	80 hours 520 liter	90 hours 600 liter	100 hours 665 liter
Clean dust scrapers (after 1 hour)										
Bleed fork legs regularly - after every cleaning										
Check the inner tubes on scratches / leakage	●	●	●	●	●	●	●	●	●	●
Visual check of damaging of the outer-tubes / replace if necessary	●	●	●	●	●	●	●	●	●	●
Complete service without disass. the closed cartridge of the fork	●			●				●		
Complete service including the closed cartridge of the front fork		●				●				●

# DISMOUNTING/MOUNTING THE FORK

# 3

## INDEX

<b>DISMOUNTING THE FORK .....</b>	<b>3-2</b>
<b>MOUNTING THE FORK .....</b>	<b>3-3</b>





### Dismounting the fork

- Place your motorcycle on a stand.



- Notice the position of the front fork in the triple-clamps.



NOTE: To remove the front fork. Read your KTM Instruction Manual or Workshop Manual.







### Mounting the fork

- Clean the innerside of the triple-clamps with brake cleaner.
- Slide both fork legs into the triple-clamps.



NOTE: Pay attention to the position of the fork legs.

Standard riding height!



NOTE: The maximum riding height is the level of the second groove!



- Tighten the middle bolt of the lower triple clamp to a torque of 17 Nm!
- Tighten the first bolt of the lower triple clamp to a torque of 17 Nm!
- Tighten the third bolt of the lower triple clamp to a torque of 17 Nm!



- Tighten both bolts of the upper triple clamp to a torque of 20 Nm.

# DISASSEMBLING/ASSEMBLING THE FORK 4

## INDEX

<b>DISASSEMBLING THE CARTRIDGE OUT OF THE FRONT FORK LEG</b> .....	<b>4-2</b>
<b>INSPECTION OF THE SPRING</b> .....	<b>4-6</b>
<b>DISASSEMBLING THE INNER-TUBE / OUTER-TUBE</b> .....	<b>4-6</b>
<b>INSPECTION OF THE OUTER-TUBE</b> .....	<b>4-8</b>
<b>INSPECTION OF THE DU-BUSHES, SUPPORT RING AND SEALS</b> .....	<b>4-12</b>
<b>INSPECTION OF THE INNER-TUBE</b> .....	<b>4-15</b>
<b>DISASSEMBLING THE CLOSED CARTRIDGE</b> .....	<b>4-18</b>
<b>RELEASE THE NITROGEN GAS PRESSURE</b> .....	<b>4-19</b>
<b>INSPECTION OF THE PISTON ROD</b> .....	<b>4-24</b>
<b>DISASSEMBLING THE MEMBRANE HOLDER</b> .....	<b>4-26</b>
<b>INSPECTION OF THE CHECK VALVE SPRING</b> .....	<b>4-28</b>
<b>DISASSEMBLING THE SCREW SLEEVE</b> .....	<b>4-30</b>
<b>DISASSEMBLING THE REBOUND ADJUSTMENT ADAPTOR</b> .....	<b>4-33</b>
<b>DISASSEMBLING THE TAP REBOUND</b> .....	<b>4-34</b>
<b>INSPECTION OF THE REBOUND SETTING</b> .....	<b>4-37</b>
<b>DISASSEMBLING THE SCREW-CAP / MEMBRANE CC</b> .....	<b>4-38</b>
<b>ASSEMBLING THE SCREW-CAP/MEMBRANE CC</b> .....	<b>4-44</b>
<b>DISASSEMBLING THE TAP COMPRESSION</b> .....	<b>4-49</b>
<b>INSPECTION OF THE COMPRESSION SETTING</b> .....	<b>4-51</b>
<b>ASSEMBLING THE TAP COMPRESSION</b> .....	<b>4-51</b>
<b>ASSEMBLING THE HOLDER MEMBRANE</b> .....	<b>4-53</b>
<b>ASSEMBLING THE TAP REBOUND</b> .....	<b>4-56</b>
<b>ASSEMBLING THE REBOUND ADJUSTMENT ADAPTOR</b> .....	<b>4-59</b>
<b>ASSEMBLING THE SCREW SLEEVE</b> .....	<b>4-60</b>
<b>ASSEMBLING THE CLOSED CARTRIDGE (MODEL 2005)</b> .....	<b>4-62</b>
<b>ASSEMBLING THE CLOSED CARTRIDGE (STARTING WITH MODEL 2006)</b> .....	<b>4-66</b>
<b>BLEEDING THE CLOSED CARTRIDGE (MODEL 2005)</b> .....	<b>4-69</b>
<b>BLEEDING THE CLOSED CARTRIDGE (STARTING WITH MODEL 2006)</b> .....	<b>4-71</b>
<b>ON PRESSURE WITH NITROGEN</b> .....	<b>4-74</b>
<b>ASSEMBLING THE INNER-TUBE / OUTER-TUBE</b> .....	<b>4-76</b>
<b>ASSEMBLING THE CARTRIDGE IN THE FRONT FORK LEG</b> .....	<b>4-82</b>
<b>FILLING OIL IN THE FRONT FORK LEG</b> .....	<b>4-84</b>





### Disassembling the cartridge out of the front fork leg

- Place clamping block T1403S in the vice.

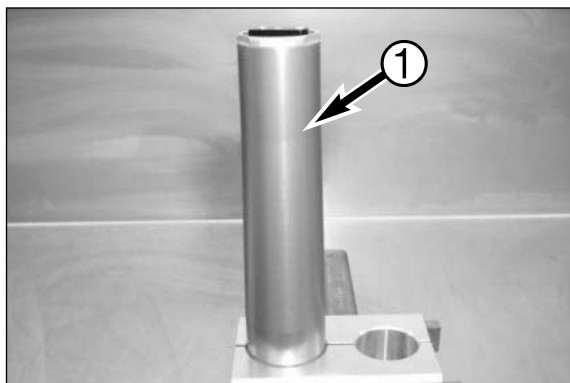

- Clamp the outer-tube ❶ of the front fork leg in the clamping block at the level of the lower triple-clip.

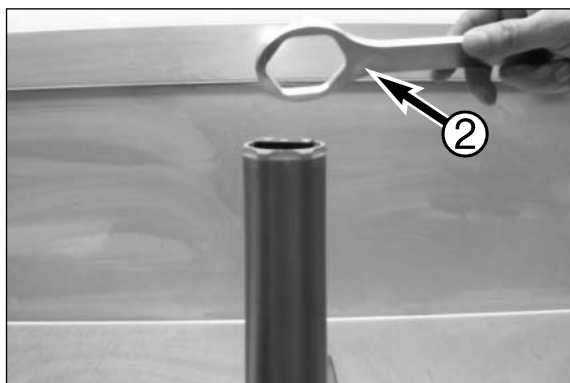

- Place T14.017 ❷ on the screw-cap of the front fork leg.



- Loosen the screw-cap.

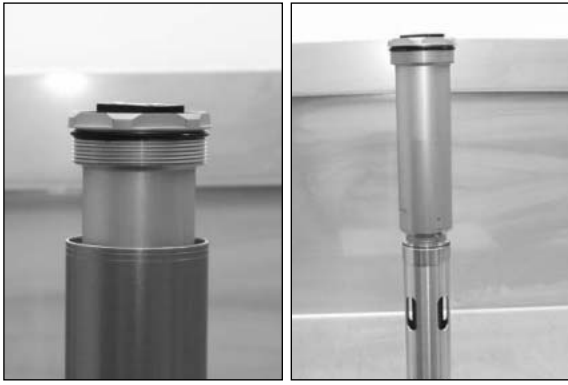

- Remove the front fork leg out of the vice and move the outer-tube downwards to the axle-clamp.



- Drain the oil out of the front fork leg.
- Only for replacing the spring or changing the spring preload!



- Place the front fork leg in the vice according to the picture.

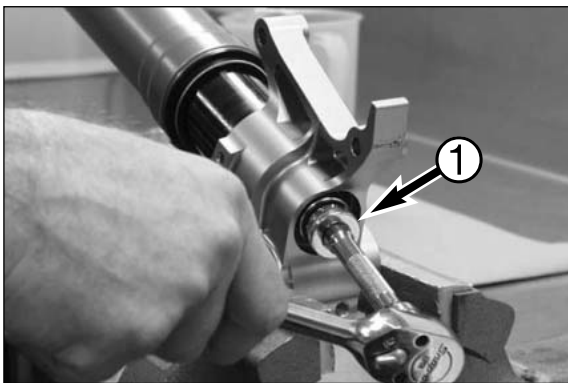

- Unscrew the rebound adjustment holder ❶ out of the axle-clamp, (Size 19).

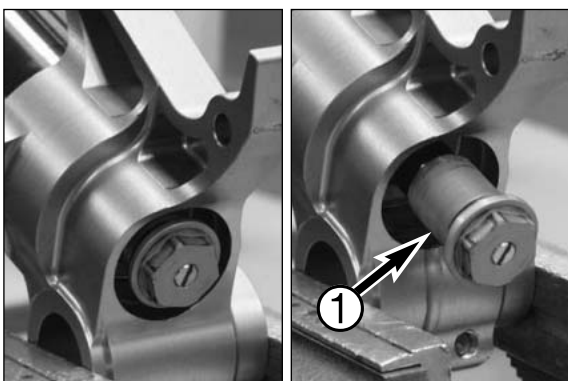

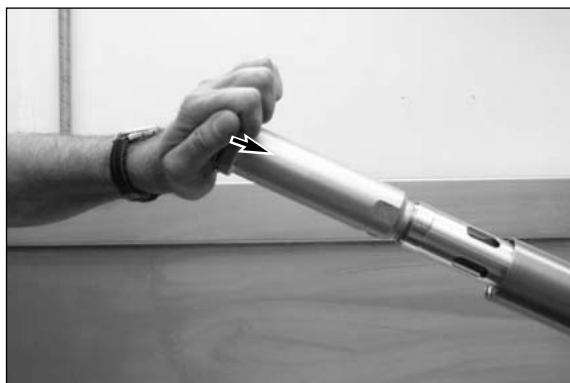

- Push the cartridge downwards and place T14.020 ❶ over the piston-rod, just below the contra nut. (art. no. 4860.0459)

NOTE: Do this with help of a second person.

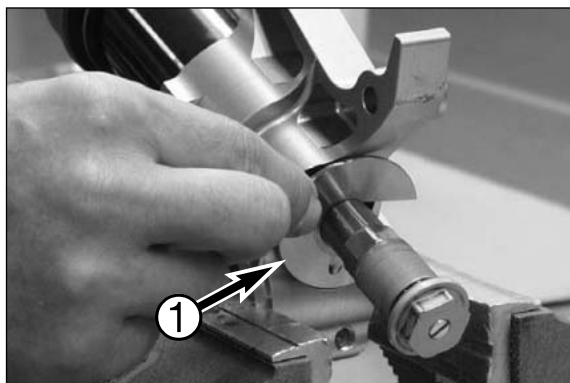

- Screw the rebound adjustment holder from the nut, (Size 19 and 17)

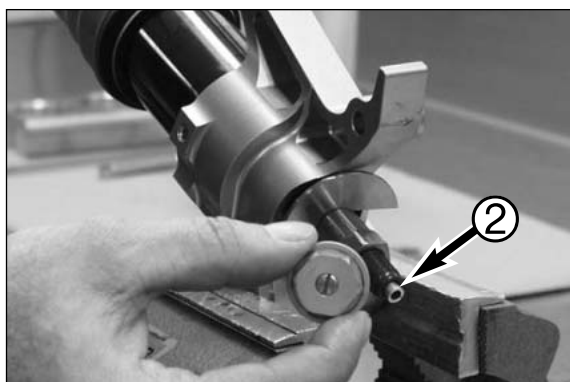

- Unscrew the rebound adjustment holder from the piston-rod.
- Pay attention to the rebound adjustment tube ❷, remove it when it comes out of the piston-rod!

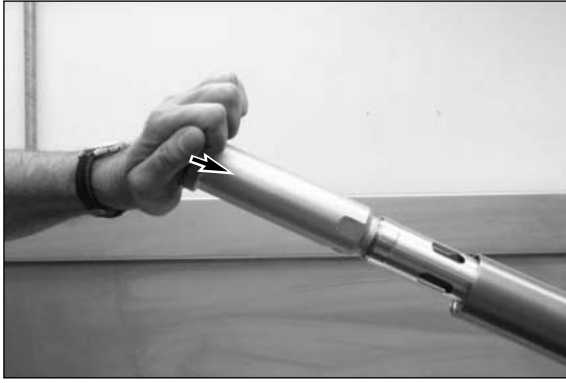

- Push the cartridge downwards and remove T14.020 ❶.

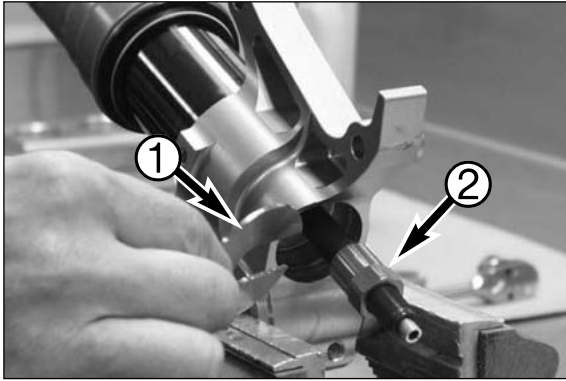

- Remove the nut ❷.

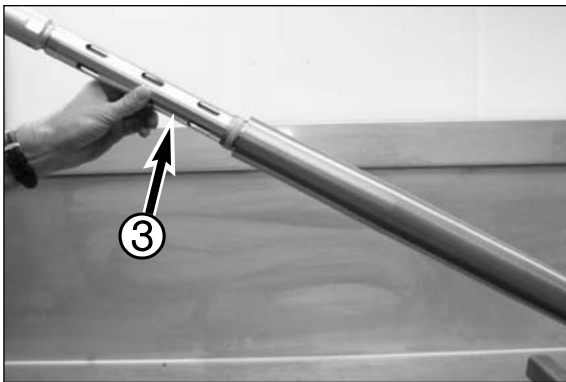

- Release the spring pressure on the cartridge slowly.
- Remove the closed cartridge ❸ complete.



- "The closed cartridge complete" SXS 2005/06.



- "The closed cartridge complete" SX 2007

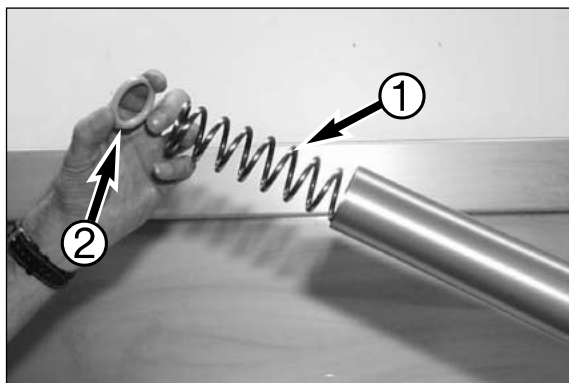

– Remove the spring ❶ with the spacer ❷.

– Also remove the bushing on the lower end of the spring (2006 model).



### Inspection of the spring

NOTE: Only for replacing the spring or changing the spring preload!

- It is necessary to place the front fork leg according to the picture for about 5 minutes. The amount of rest oil that stay left in the front fork leg is  $\pm 10\text{ml}$ .
- See the setting list for the correct amount of oil volume, this oil volume is minus the 10ml of rest oil.

For example  $385\text{ml} - 10\text{ml} = 375\text{ml}$ .

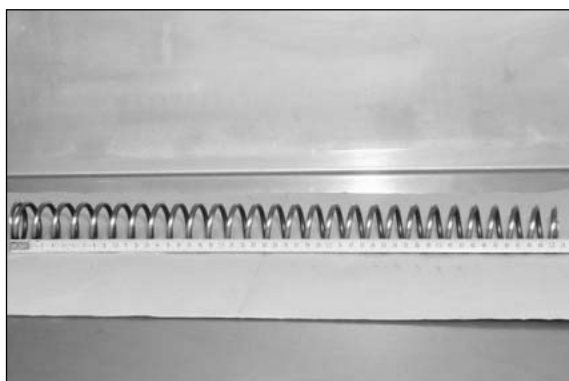

Model 2005:

– The total length of the spring (without spacers) is  $505\text{mm} \pm 3\text{mm}$ .

– Replace the spring when the total length is less then 495mm.

model 2006 onwards:

– The total length of the spring (without spacers) is  $455\text{mm} \pm 3\text{mm}$ .

– Replace the spring when the total length is less then 447mm.

– Inspect the coils of the spring if they are not flat, incase they are, you have to replace the spring.

### Disassembling the inner-tube / outer-tube

– Place the front fork leg in the vice according to the picture.

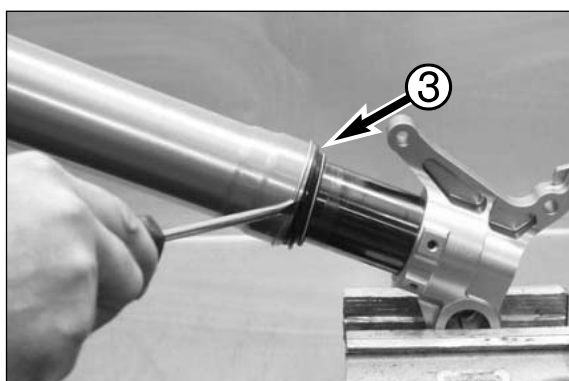

– Remove the dust stripper carefully ❸.



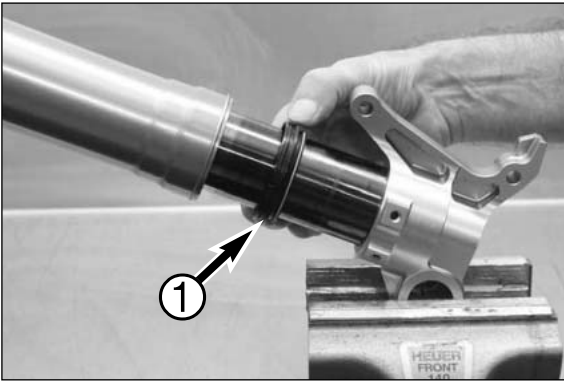

- Slide the dust stripper ❶ downwards.



- Remove the lock washer with a screwdriver.

NOTE: The lock washer is on one side chamfered to disassemble it easier!



- Heat the surface of the outer-tube near the oil seal to a temperature of  $\pm 50^{\circ}\text{C}$ .

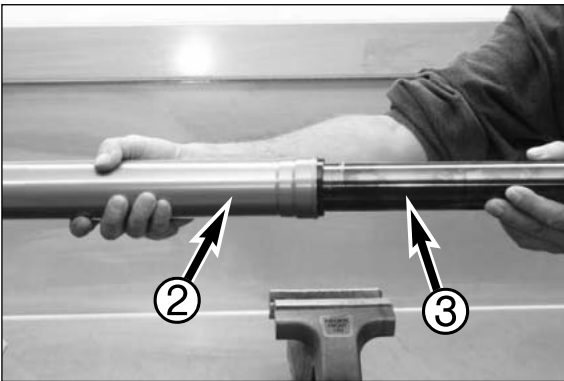

- Remove the front fork leg out of the vice and pull with both hands the outer-tube from the inner-tube. ❷ vom Innenrohr ❸.

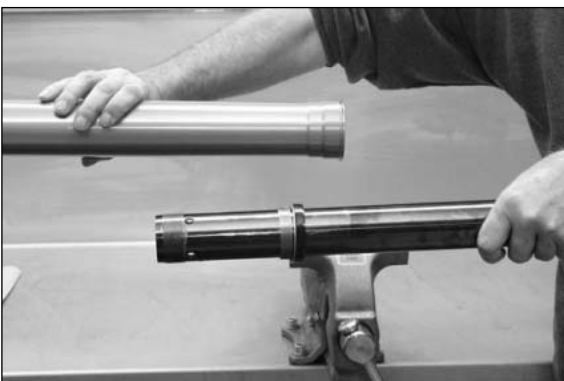



### Inspection of the outer-tube

- The outer-tube.

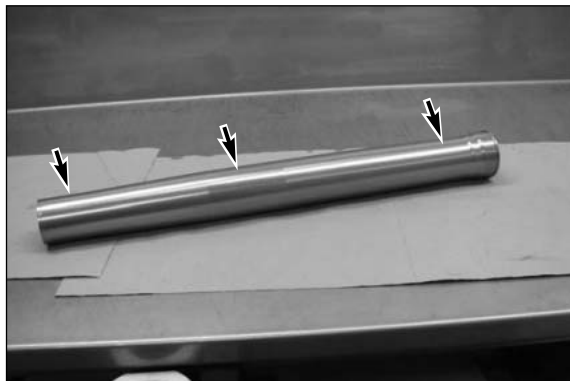

- Inspect the outside surface of the outer-tube if there isn't any damage because of (for example) stones.



- Inspect the inside running surface of the outer-tube on scratches.
- Also inspect the anodized coating of the running surface.

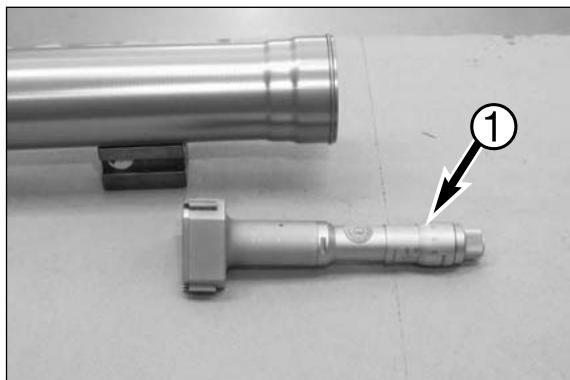

- Micrometer ❶ for measuring the oil seal and DU-bush chambers of the outer-tube.



- Measure the chamber for the DU-bush.

The maximum diameter is: 52.15 mm



- Measure the chamber for the oil seal.

The maximum diameter is: 57.50 mm



- Micrometer for measuring the diameter of the running surface of the outer-tube.



- Place at the side of the screw cap the micrometer  $\pm 300$ mm into the outer-tube.
- Measure the diameter of the running surface and measure again after rotating the outertube  $90^\circ$ .

The maximum diameter is: 49.20mm

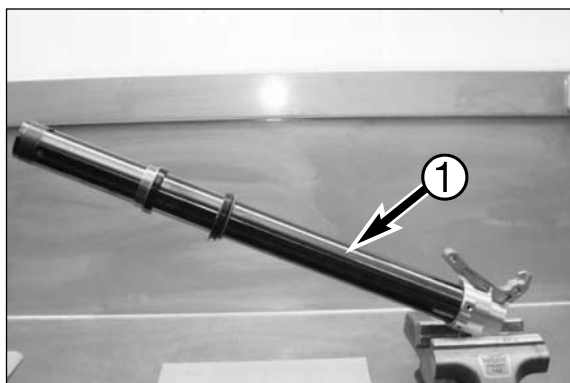

– Place the inner-tube ① in the vice according to the picture.

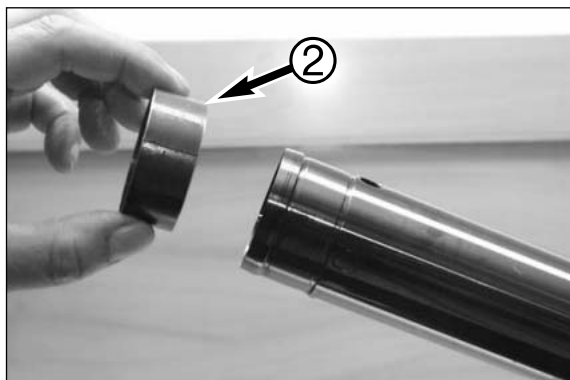

– Remove the DU-bush ② from the inner-tube.

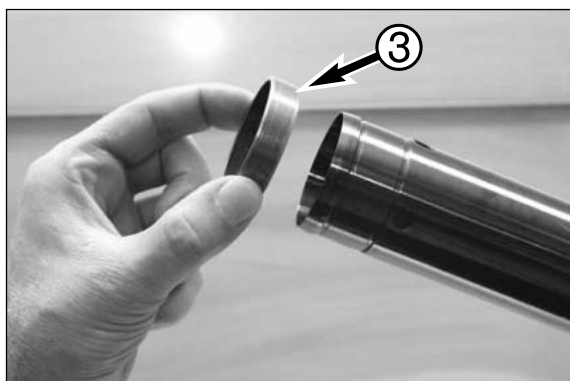

– Remove the outer-tube DU-bush ③.

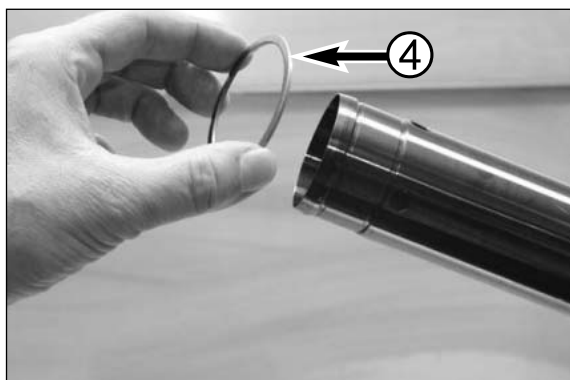

– Remove the support ring ④.

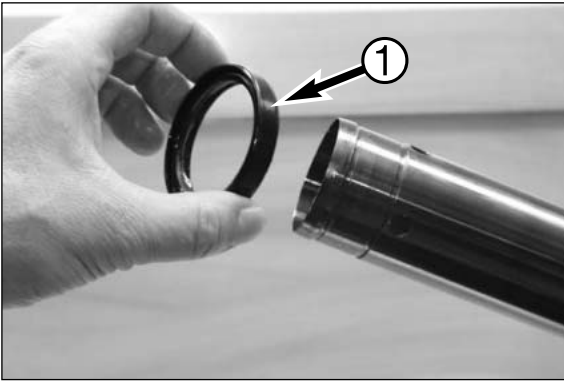

– Remove the oil seal ①.

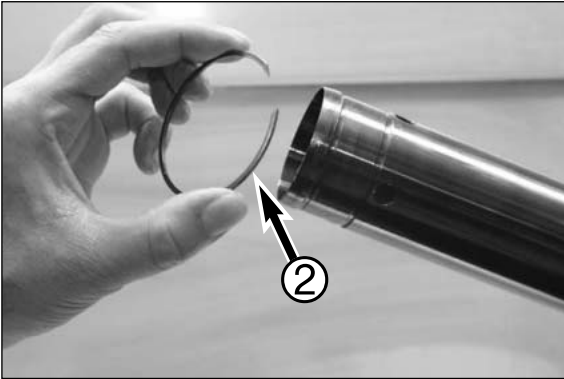

– Remove the lock ring. ②.

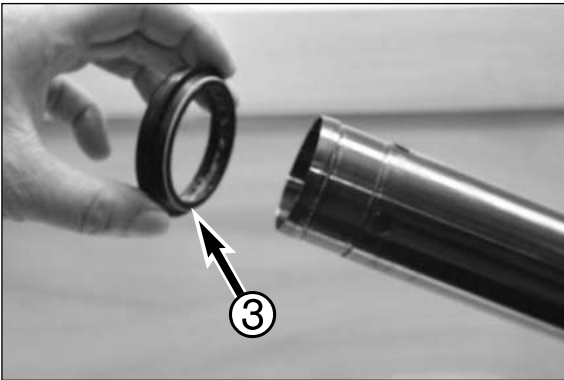

– Remove the dust stripper ③.

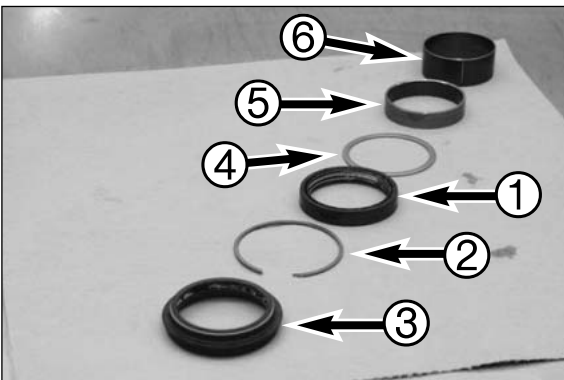

– Dust stripper ③  
 – Lock ring ②  
 – Oil seal ①  
 – Support ring ④  
 – DU-bush outer-tube ⑤  
 – DU-bush inner-tube ⑥

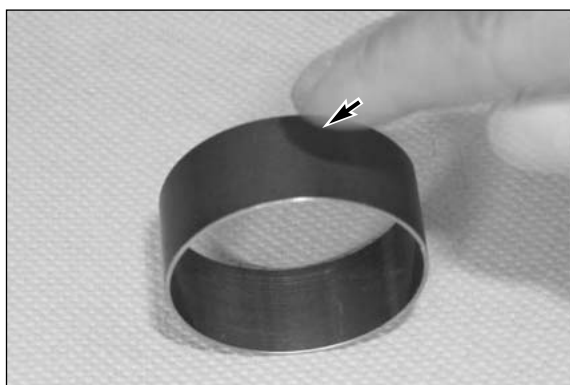

### Inspection of the DU-bushes, support ring and seals

- Replace the DU-bush of the inner-tube if the surface is feeling rough.

NOTE: The best way to do this is to compare it with a new one!



- Replace the DU-bush when you see through the surface a bronze color.



- Replace the DU-bush of the outer-tube if the surface is feeling rough.

NOTE: The best way to do this is to compare it with a new one!



- Replace the DU-bush when you see through the surface a bronze color.



- Check if the support ring is not bended.



- Always replace the dust stripper and oil seal with every service!  
See periodic service interval!

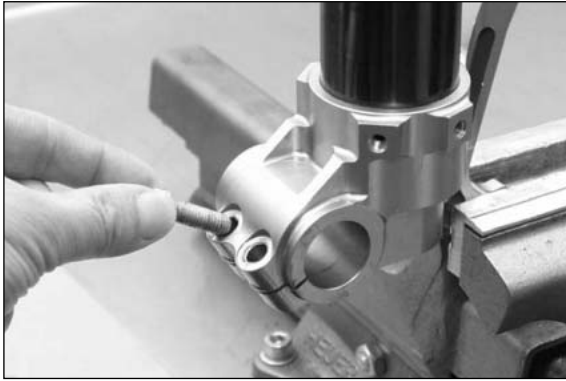

- Unscrew both bolts out of the axle-clamp.



- Heat the axle-clamp.

NOTE: the inner tube and axle clamp come as a unit for SX models starting in 2007 and do not need to be disassembled.

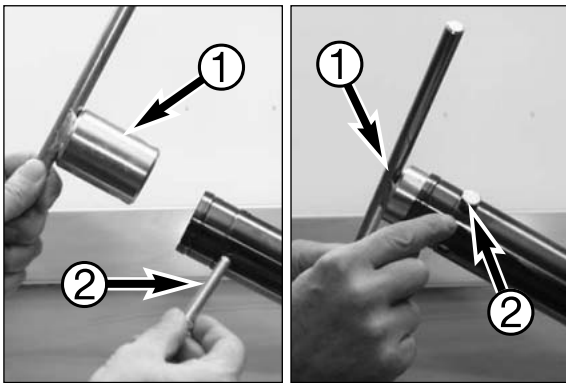

- Place T1404S ① in the inner-tube with the pin (T605) ② through the holes of the inner-tube.



- Loosen the inner-tube.

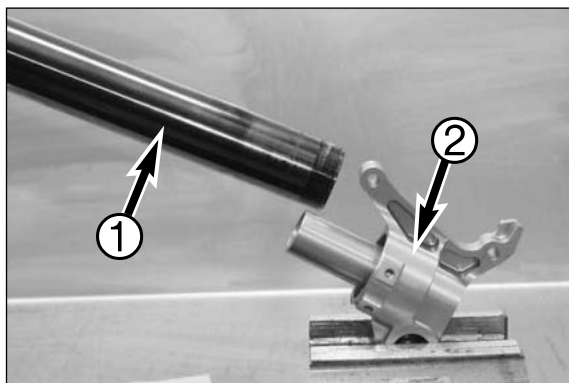

- Unscrew the inner-tube ❶ from the axle-clamp ❷.



- Take the axle-clamp out of the vice.



- Axle-clamp complete!



**Inspection of the inner-tube**

- Inner-tube.

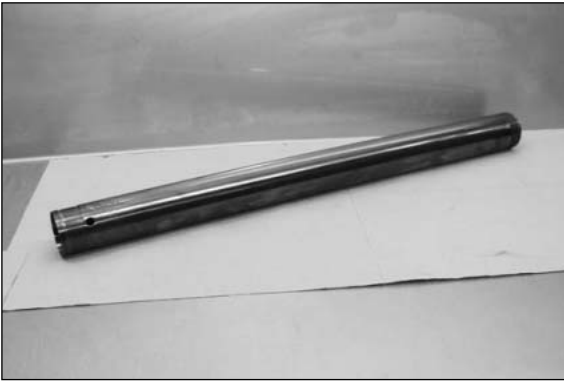

- Inspect the outside running surface of the inner-tube on scratches, wear and tear.

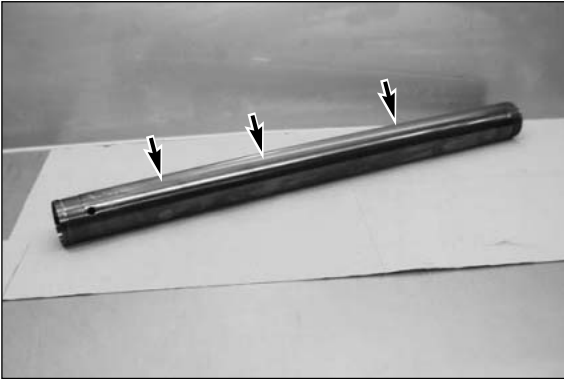

NOTE: When the scratches are sharp and they are not too deep, polish them with “Scotch Brite” hand pad.



- Micrometer for measuring the outside diameter of the inner-tube.





- Measure the outside diameter of the inner-tube, rotate the inner-tube 180° and measure again. Repeat these measurements on several places of the inner-tube.

The maximum diameter is: 48.005mm

The minimum diameter is: 47.950mm

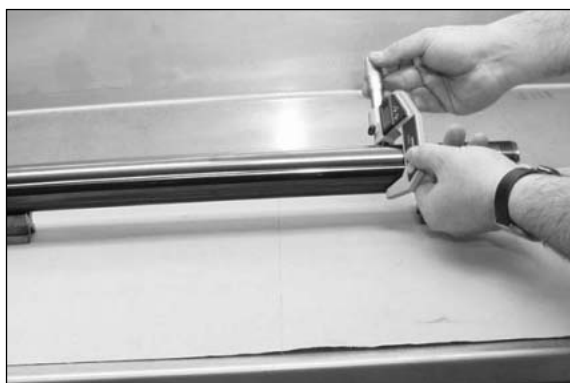

- Clock gauge for measuring the straightness of the inner-tube.

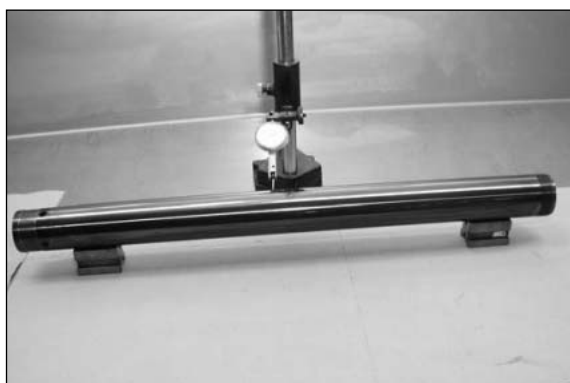

- Measure the straightness of the inner-tube.

**NOTE:**

- Place the V-blocks as far as possible at the sides of the running surface of the innertube according to the picture
- Place the gauge clock in the middle of the inner-tube.
- Rotate the inner-tube 360°.

The maximum travel is: 0.06mm

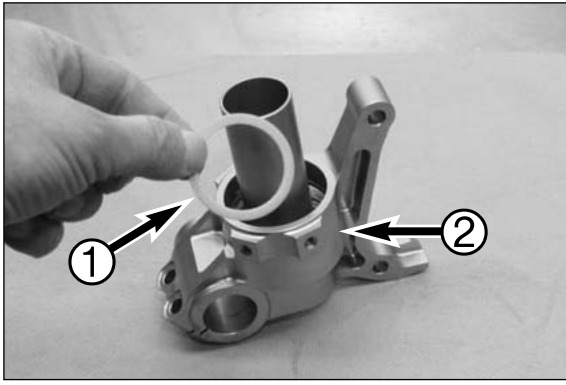

- Take the spacer ① out of the axle-clamp ②.

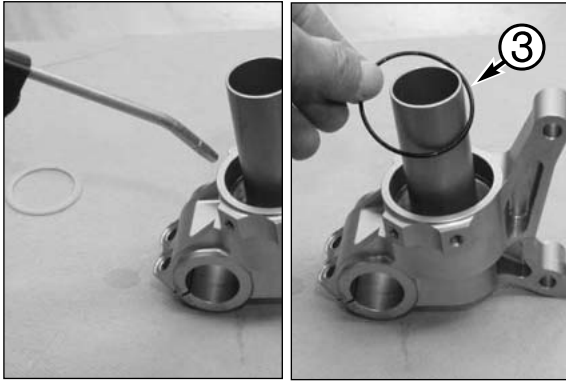

- Use air pressure to remove the O-ring ③ out of the groove of the axleclamp.

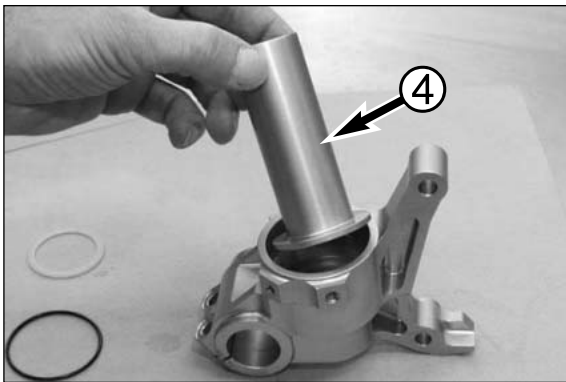

- Remove the hydraulic sleeve ④.



- Axle-clamp with components.



### Disassembling the closed cartridge

- The closed cartridge complete.



- Remove the rebound adjustment tube ❶.



- Clamp the reservoir of the cartridge in the vice according to the position of the picture.



- Hold the rebound adjusting screw ❷ and loosen the screw ❸.



### Release the nitrogen gas pressure

- Unscrew the Allen bolt **1** that is nearest to the compression adjustment screw, (Size 3).
- Remove the Allen bolt **1** with the seal out of the screw-cap.

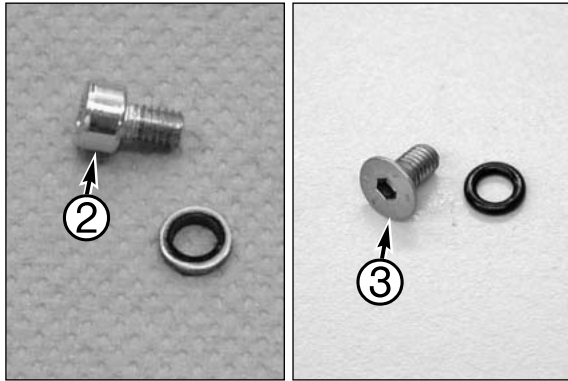

- Model 2005: Allen bolt **2** with the seal.
- From model 2006 on: AH flat-head screw **3** with O-ring.

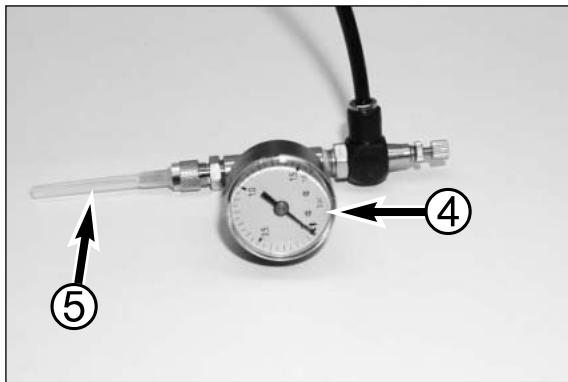

- Special tool T14.019 **4**.



- Remove the protecting cap **5** of the needle and stick the needle through the middle of the filling rubber plug.

NOTE: you will hear that the nitrogen gas pressure is releasing the membrane.

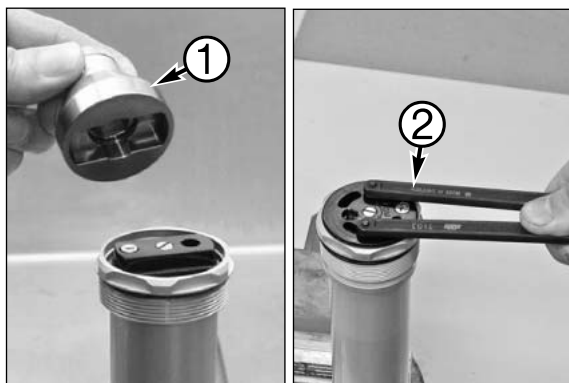

- 2005: place T14.018 ❶ on the screw-cap.
- 2006: place T103 ❷ on the screw-cap.



- Loosen the screw-cap of the membrane holder.



- Lift with a screw driver the screw-cap ❸ of the membrane holder out of the reservoir.



- Take the membrane holder ❹ out of the reservoir.



- Drain the oil out of the cartridge.

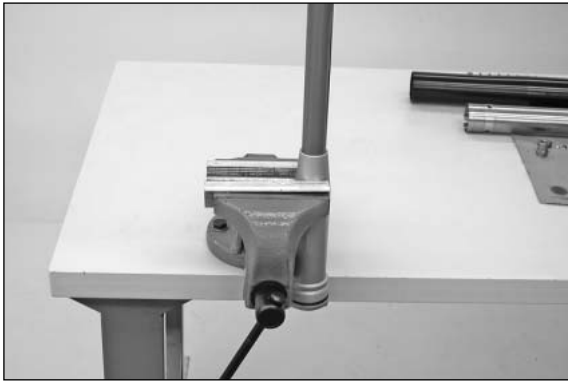

- Clamp the closed cartridge in the vice according to the picture!

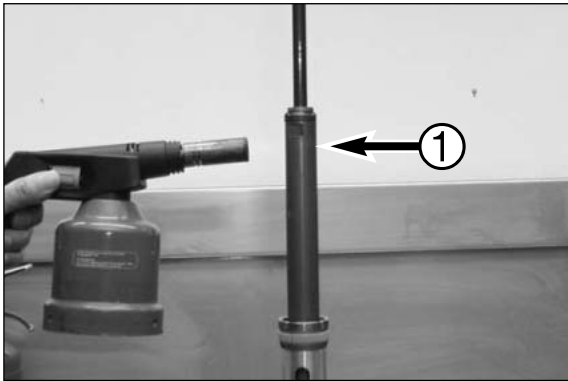

- Heat the screw sleeve ❶.

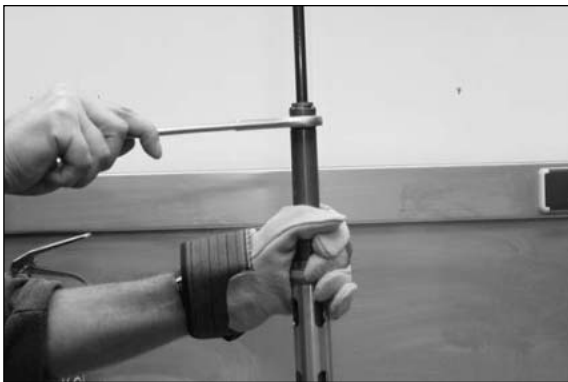

- Loosen the screw sleeve, (Size 24)



- Unscrew the screw sleeve out of the tube.



- Pull the piston rod out of the tube.

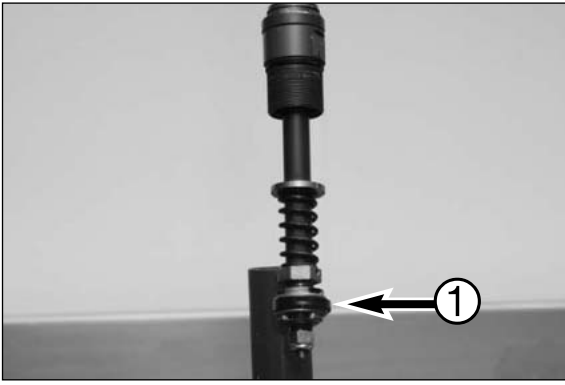

- The complete piston rod with the rebound setting - pay attention to the piston ring **1**!

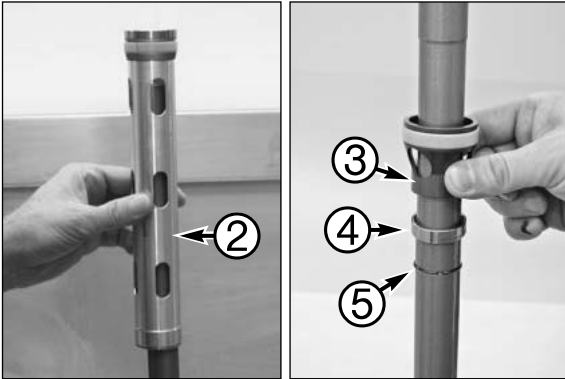

- Remove the tube **2** (SXS) or guiding ring adapter **3** (SX).
- Remove the support ring **4** and the lock ring **5** (SX only).



- Tube d35xD37.5 with guiding ring **6**.

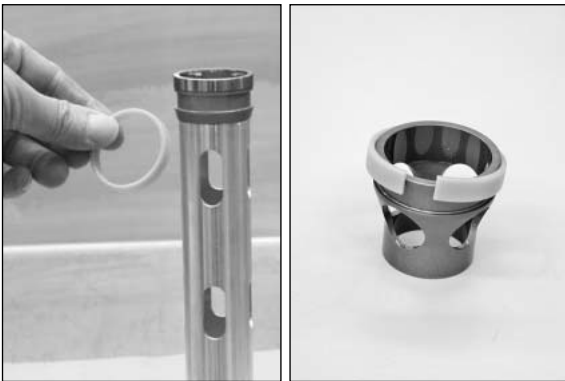

- Remove the guiding ring.



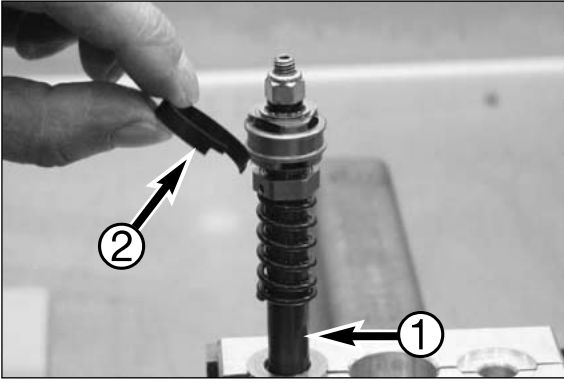

– Place clamping block T14.016 in the vice.

NOTE: Place the piston rod ① in the vice according to the picture.

– Remove the piston ring ②.

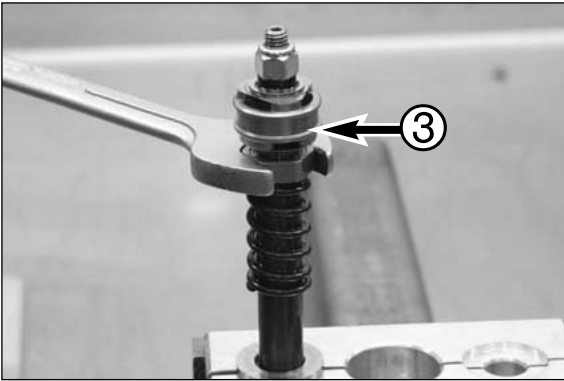

– Loosen the tap rebound ③, (Size 17).



– Screw the tap rebound with needle and spring out of the piston rod.

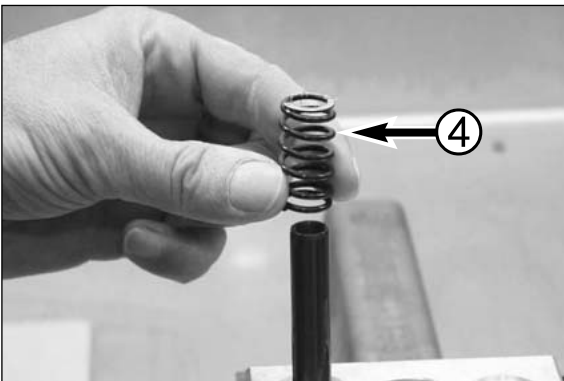

– Remove the rebound spring ④.

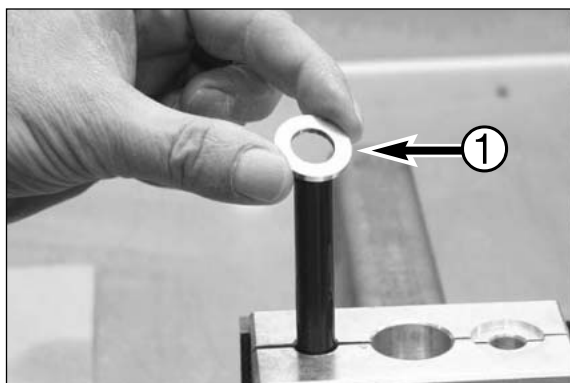

- Remove the steel washer ❶.

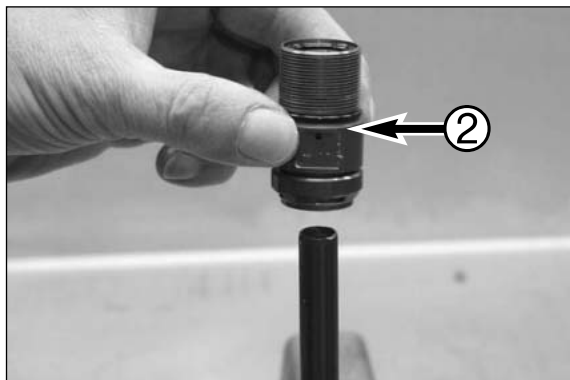

- Remove the screw sleeve ❷.



#### Inspection of the piston rod

- Piston rod.
- Replace the piston rod if you have inspect that the surface of the piston rod has scratches and or indentations.
- Always replace also the DU-bush d12 of the screw sleeve.

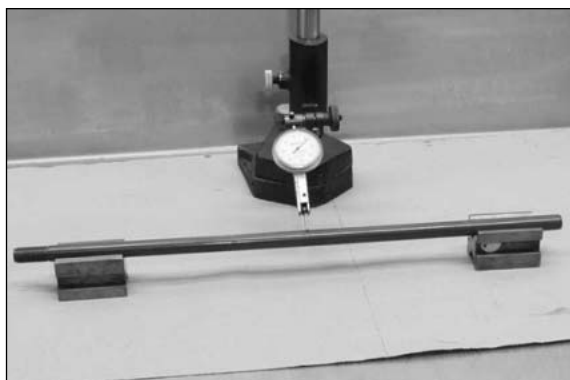

- Use a clock gauge for measuring the straightness of the piston rod.
- Measure the straightness of the piston rod, rotate the piston rod 360°.

The maximum travel is: 0.12 mm



- Micrometer.
- Measuring the outside diameter of the piston rod.

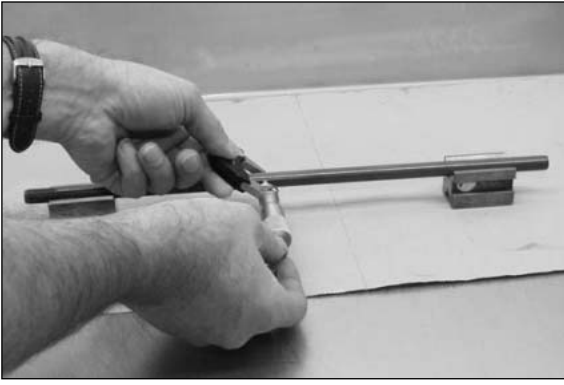

- Measure the diameter of the piston rod, rotate the piston rod 90° and measure the diameter again.
- Repeat these measurements on several places of the piston rod.

The maximum diameter is: 12.00 mm.

The minimum diameter is: 11.92 mm.

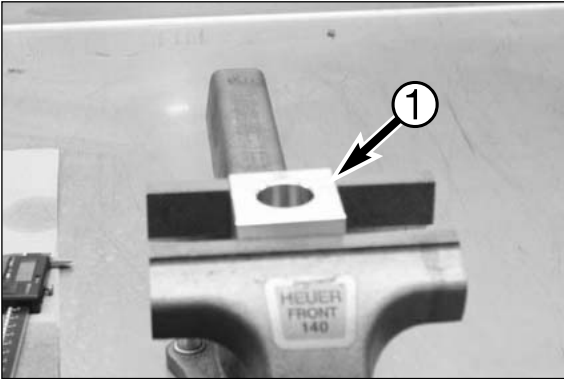

- Place clamping block T14.015 ① in the vice.

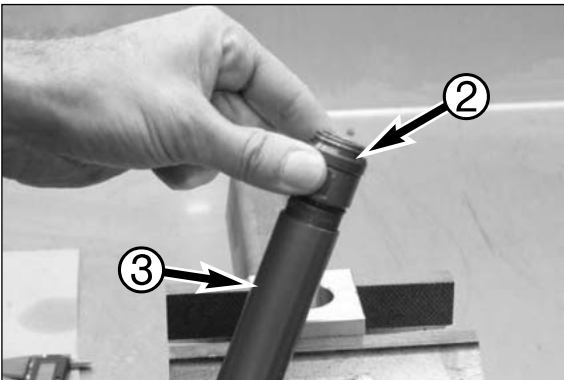

- Screw the screw sleeve ② handtight back into the tube.③.



- Clamp the tube in the clamping block at the level of the screw sleeve.

**Disassembling the membrane holder**

- The membrane holder complete.



- Screw the plug ❶ out of the membrane holder, (Size 4) - this plug is for factory production use!

NOTE: starting in 2007 SX forks have the filling screw in this position which should be removed; drain the oil into a suitable vessel.

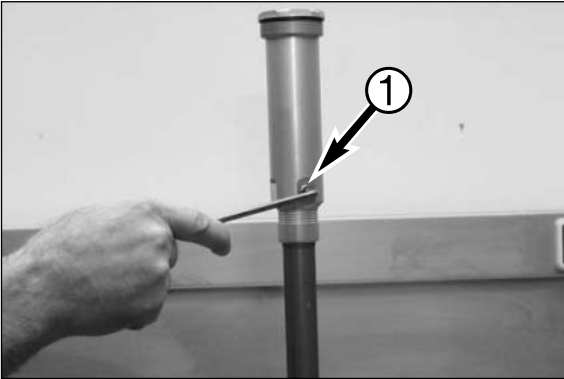

- Remove the plug.

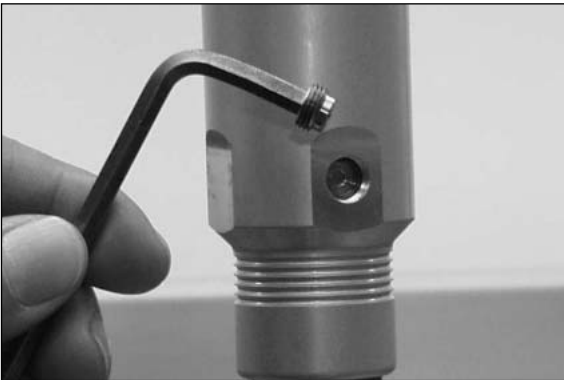

- Remove the O-ring ❷.

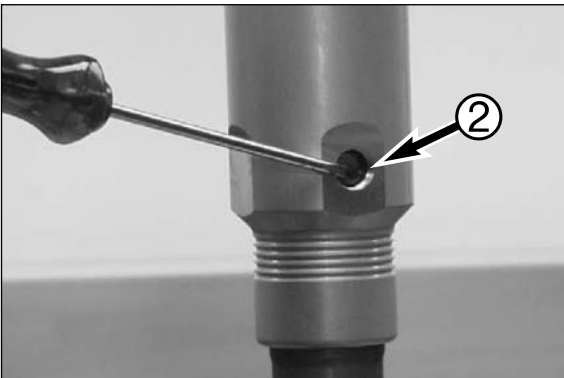

- Remove the O-ring ❸.

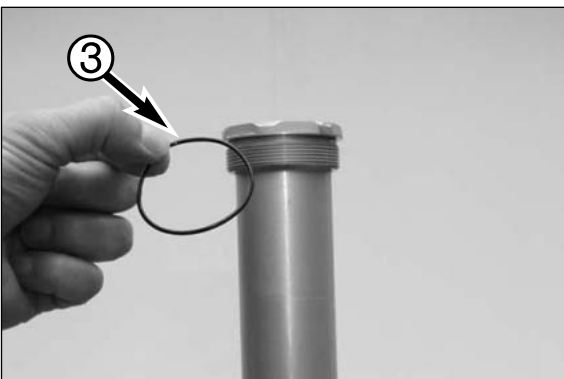

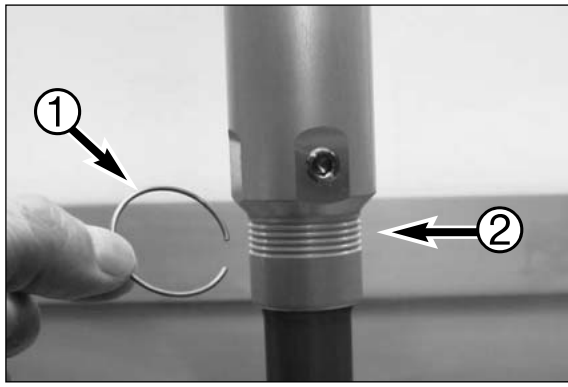

- Disassemble the spring ring ❶.

## NOTE:

- Pay attention in which groove ❷ the springring is assembled!
- By changing the position of the spring ring in the groove you will change the spring preload more or less with 1.5 mm!
- The distance between each groove is 1.5 mm.

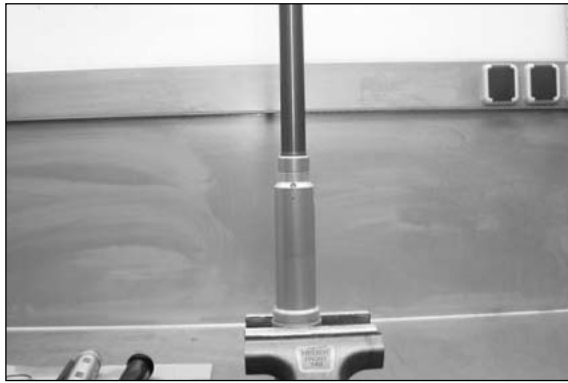

- Place the membrane holder in the vice according to the picture.

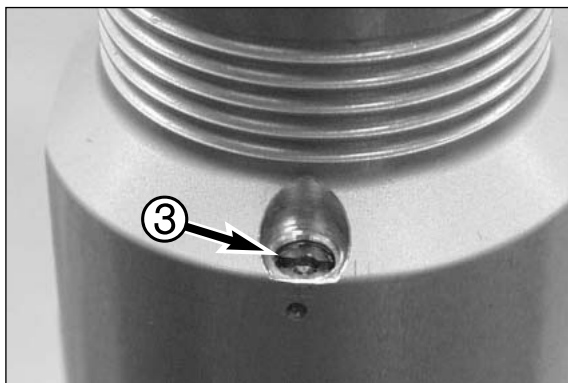

- The adjustment screw of the pressure release valve ❸.

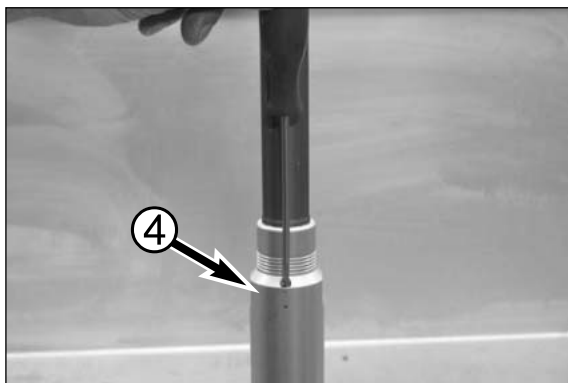

- Unscrew the adjustment screw with a correct fitting screwdriver.
- Screw the adjustment screw out of the membrane holder ❹.

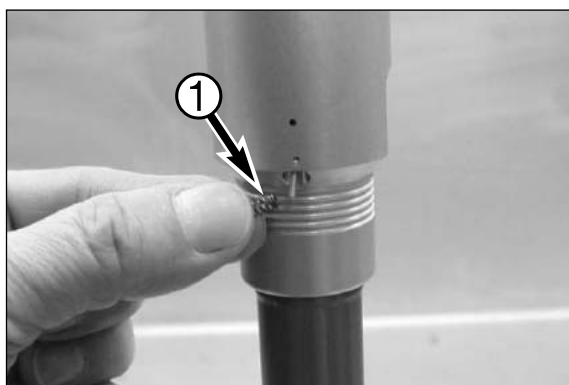

- Turn the membrane holder up side down and remove the spring. ❶.

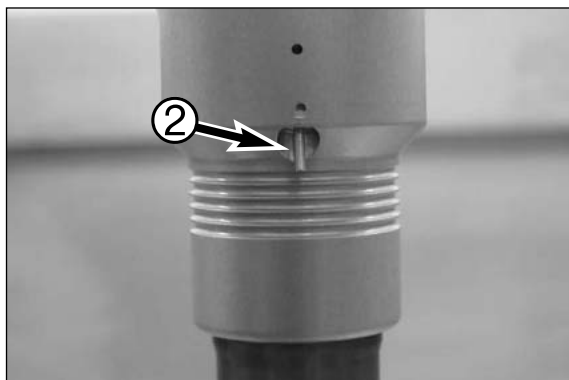

- The check valve pin. ❷.

NOTE: It is not possible to disassemble the check-valve pin out of the membrane holder!



Check valve SX 2007:

- Press against the check valve with a suitable screwdriver and lift out. Remove the check valve and the spring.



### Inspection of the check valve spring

- Check valve spring.

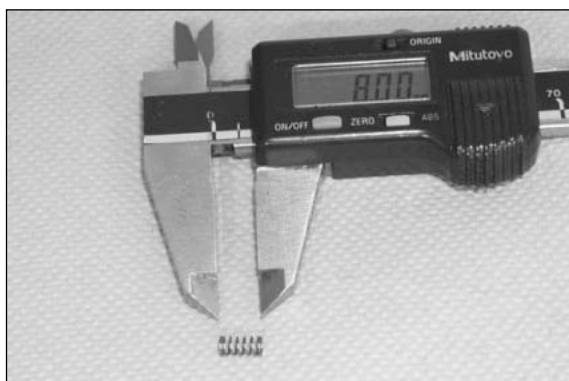

- The length of the spring must be 8.0 +/- 0.2 mm (up to model 2006) or 6.5 mm +/- 0.25 mm (2007).
- Replace the check valve spring if the length is less then 7.8 mm /6.25 mm.

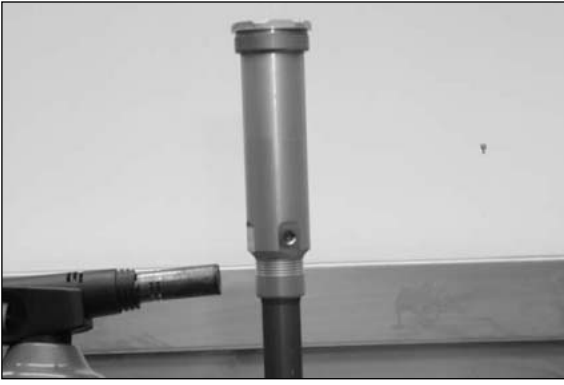

- Place the tube in the clamping block T14.015 at the level of the screw sleeve. Heat the membrane holder at the level of the spring ring groove.

NOTE: the membrane holder and tube come as a unit for SX models starting in 2007 and do not need to be disassembled.

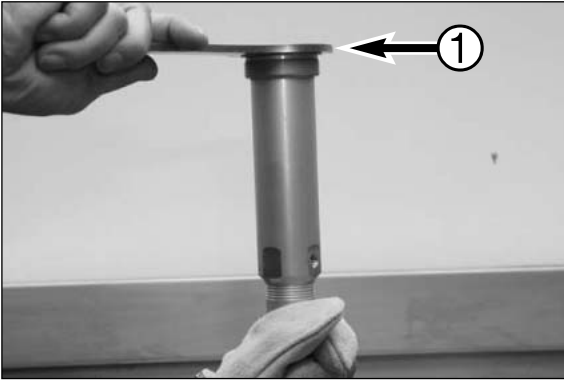

- Loosen the membrane holder with T14.017 ①.

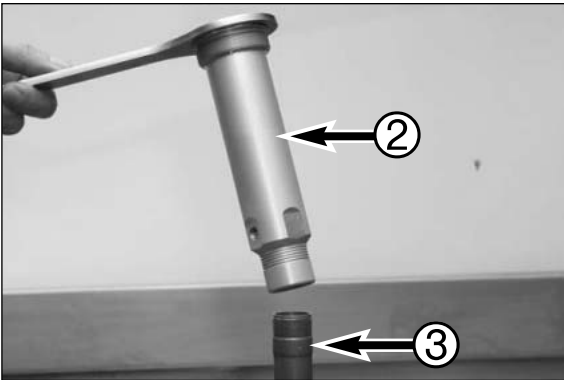

- Screw the membrane holder ② off the tube ③.

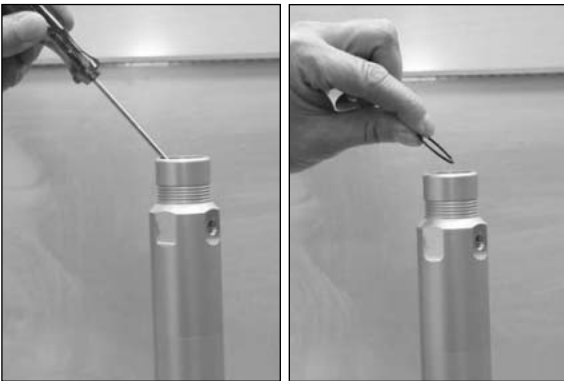

- Remove the O-ring inside.

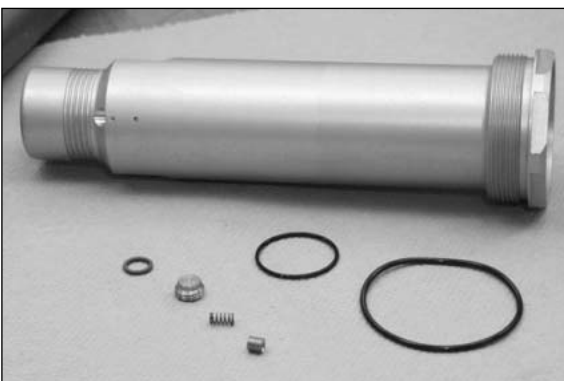

- The membrane holder with components.

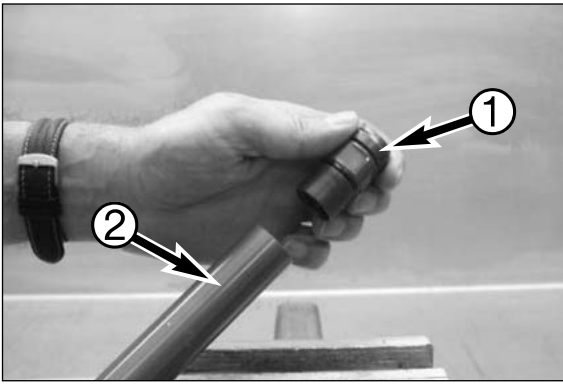

### Disassembling the screw sleeve

- Turn the screw sleeve ① out of the tube ②.



- Screw sleeve complete.

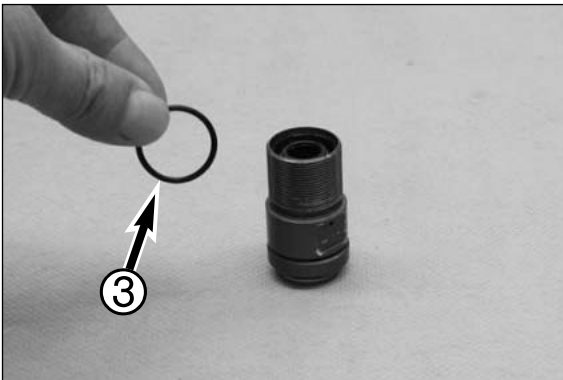

- Remove the O-ring ③.

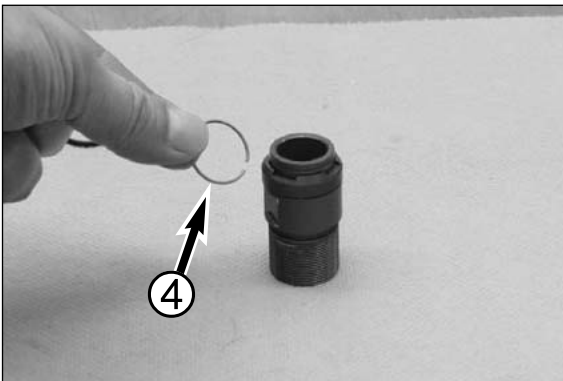

- Remove the spring ring ④.

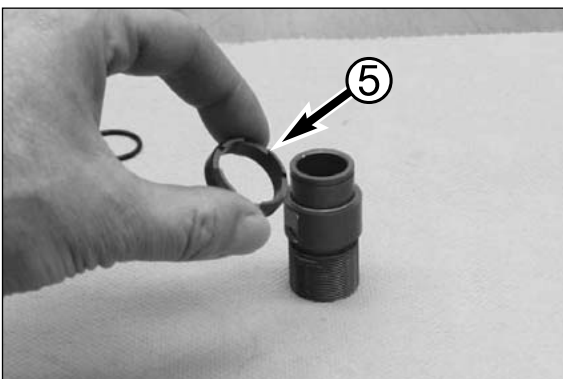

- Remove the check-valve ring ⑤.



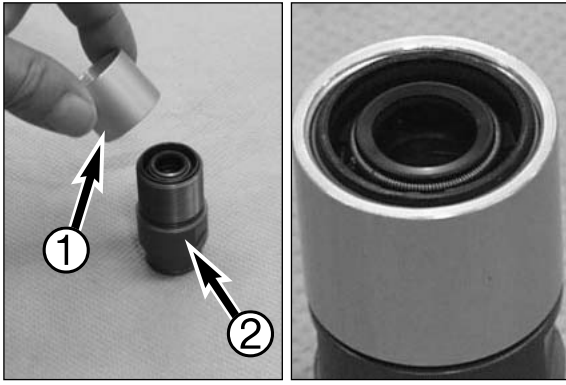

- Screw the threaded bush T14.023 ① on the screw sleeve till about 0.5 mm just above the edge of the thread of the screw sleeve ②.

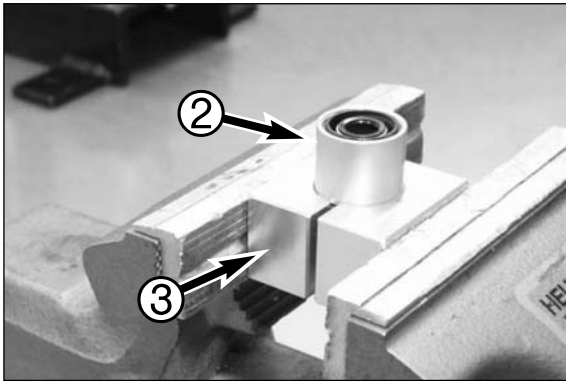

- Place the screw sleeve ② with clamping block T14.015 ③ in the vice.



- Heat the threaded bush to a temperature of approx. 50°C.

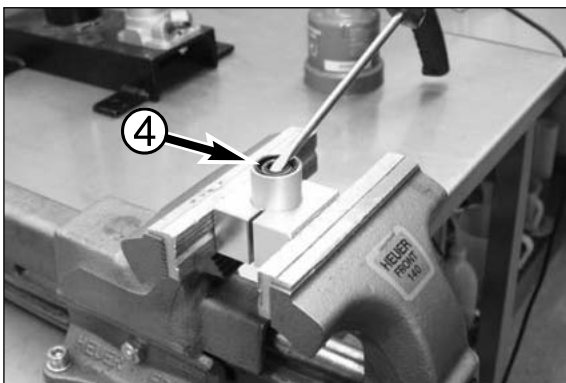

- Lift the oil seal ④ with a screw driver out of the screw sleeve.

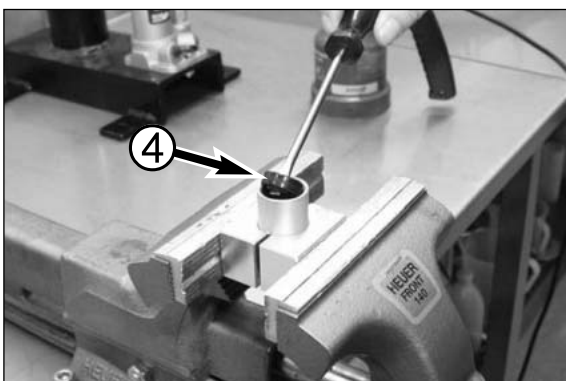

- Pay attention to the assembling direction.



- This side of the oil seal is visible when the oil seal is assembled in the screw sleeve.

NOTE: Always replace the oil seal!

**! CAUTION !**

Do NOT MOUNT THE OIL GASKET YET FOR FORKS STARTING WITH THE 2006 MODEL. IT WILL BE MOUNTED DURING ASSEMBLY.

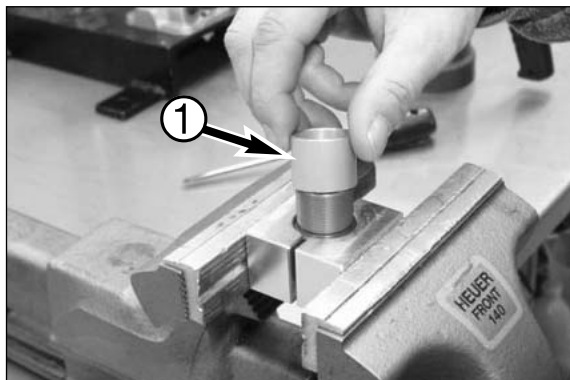

- Remove the threaded bush ①.

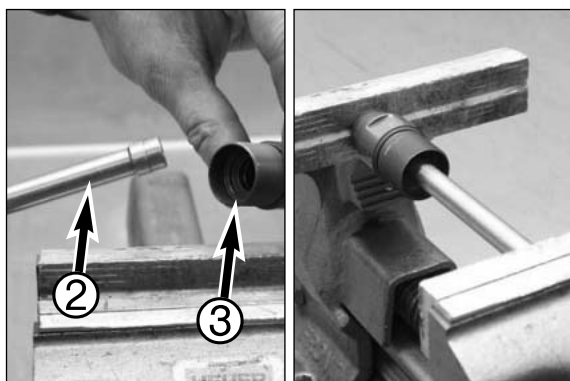

- Use T14.022 ② to press the DU-bush out of the screw sleeve ③.

NOTE: always replace the DU-bush d12 ④!

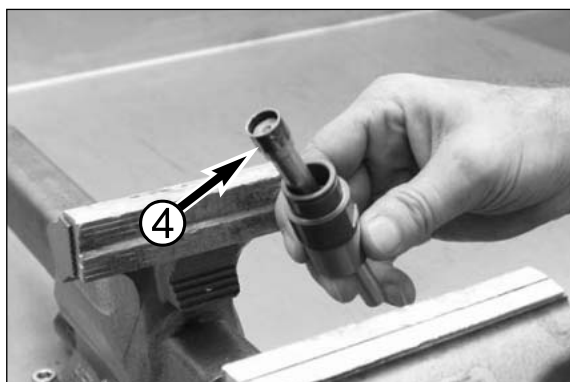

- The screw sleeve with components.
- Inspect the surface of the check valve ring ⑤ on scratches, wear and tear.

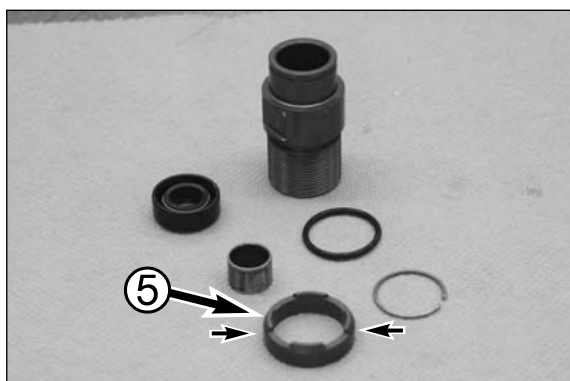

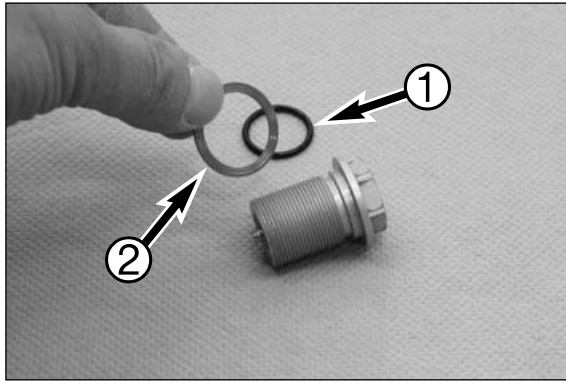

### Disassembling the rebound adjustment adaptor

- The rebound adjustment adaptor complete.
- Remove the O-ring ❶.
- Remove the copper washer ❷.

NOTE: Always replace the copper washer.

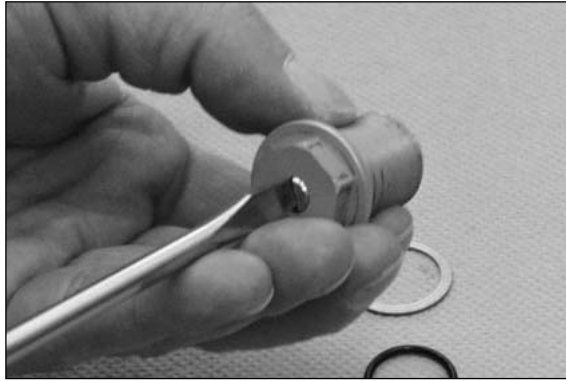

- Turn the adjustment screw clockwise and remove the needle. ❸.

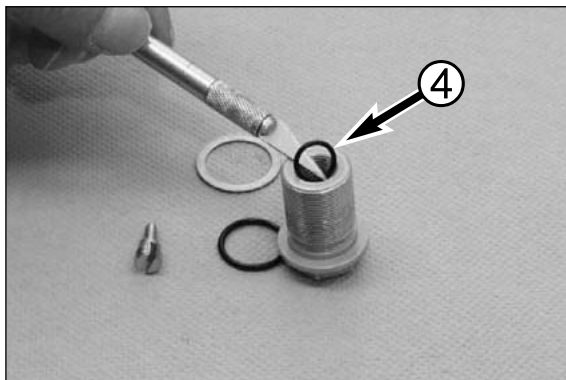
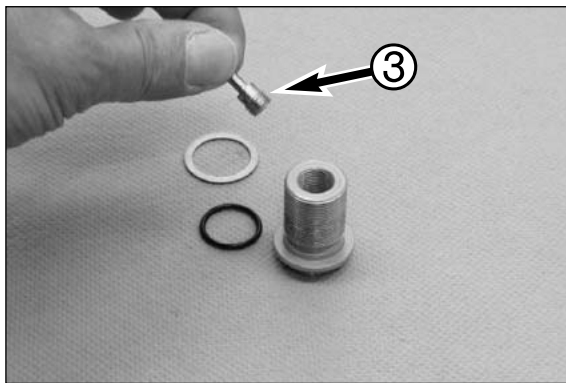

- Remove the O-ring ❹ with a hobby knife out of the groove inside the rebound adjustment adaptor.

NOTE: Always replace the O-ring.



- The rebound adjustment adaptor with components.

### Disassembling the tap rebound

– The tap rebound complete.



– Pull the rebound adjustment needle ① out of the tap rebound.

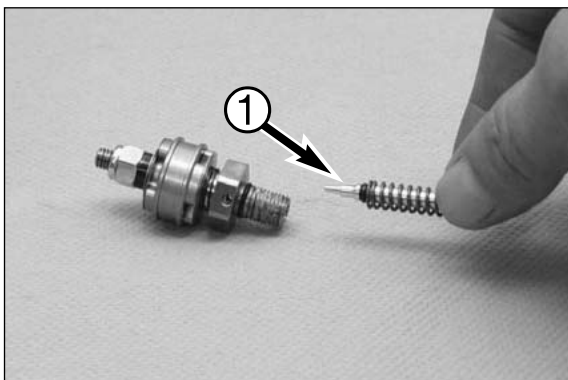

– Needle ② with spring ③.

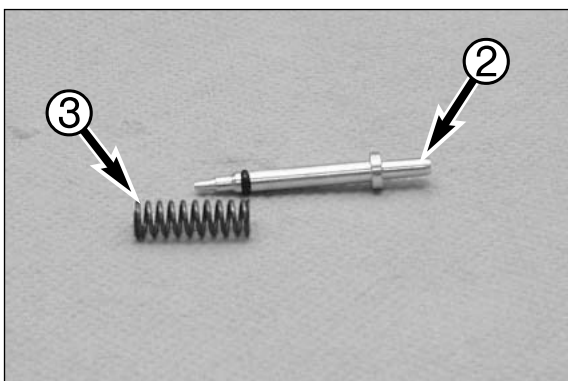

– Take the O-ring ④ of the needle.

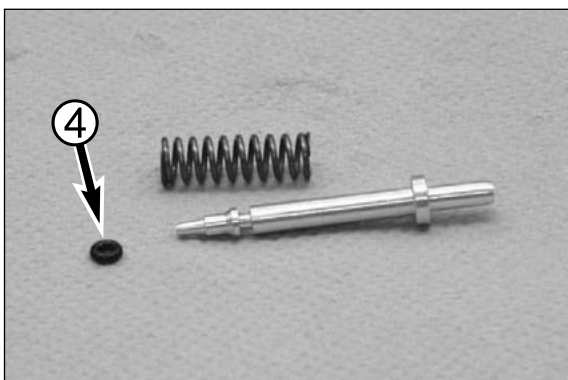

– Place the tap rebound in the vice according to the picture.

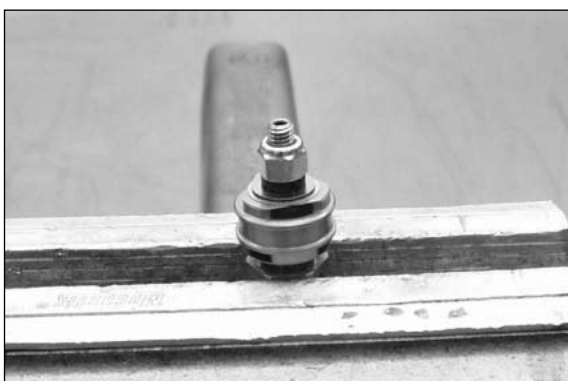

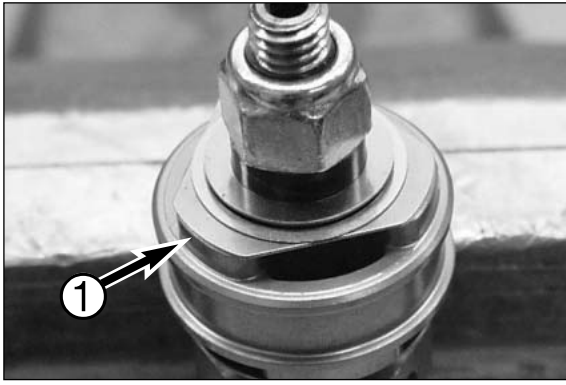

- Pay attention to the position of the rebound triangular shims ❶!



- Unscrew the lock nut.

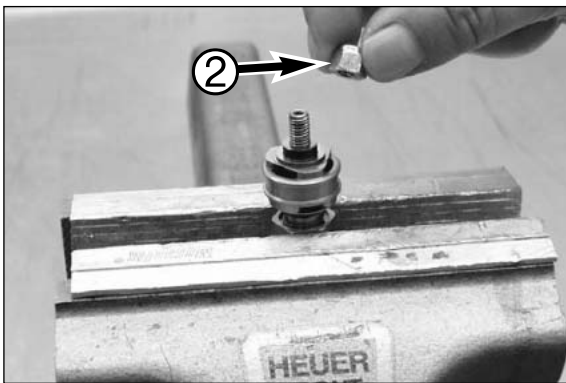

- Remove the lock nut ❷.

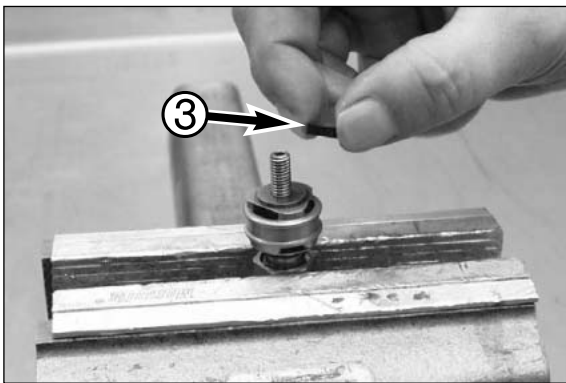

- Remove the bush ❸ (does not apply to SX 2007).

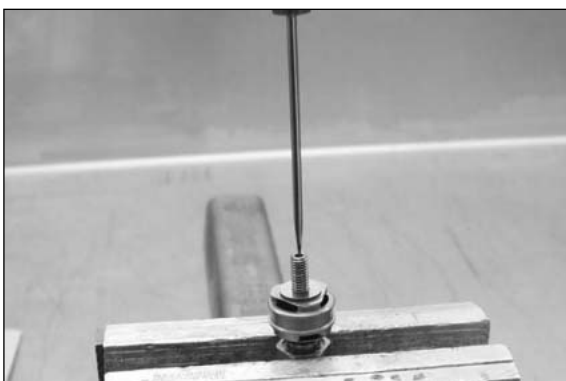

- Place a screwdriver on top of the tap rebound.

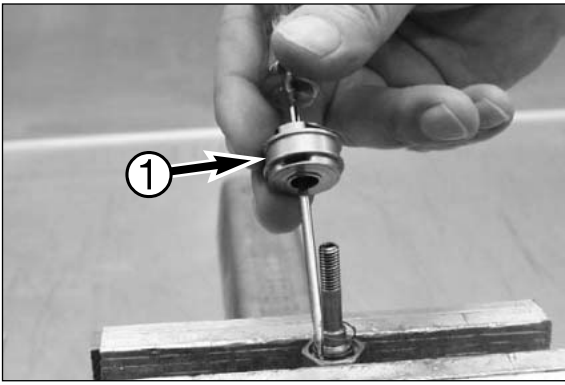

- Slide the complete rebound setting ❶ over the shaft of the screwdriver.

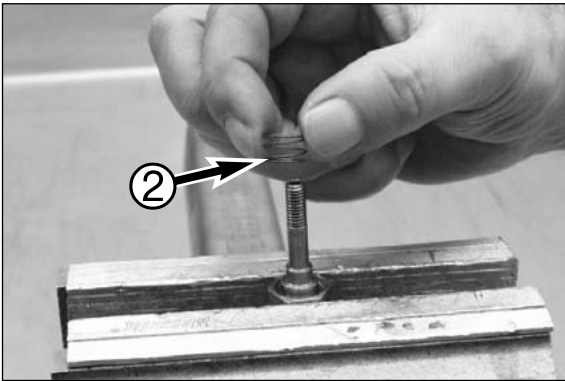

- Remove the check-valve spring ❷.

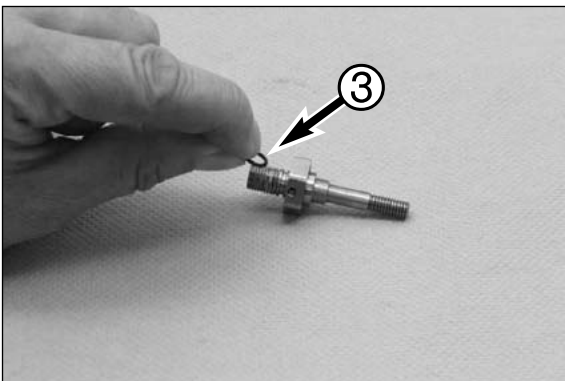

- Remove the O-ring ❸ (does not apply to SX 2007).

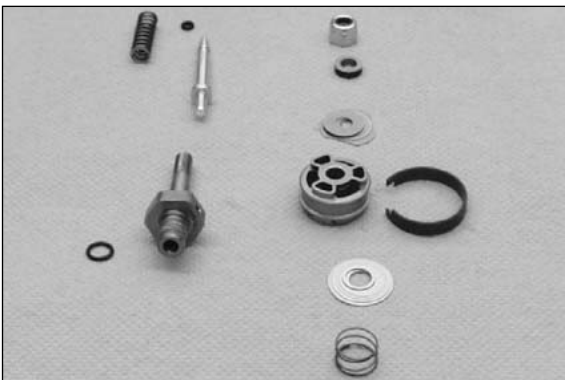

- The tap rebound with components.

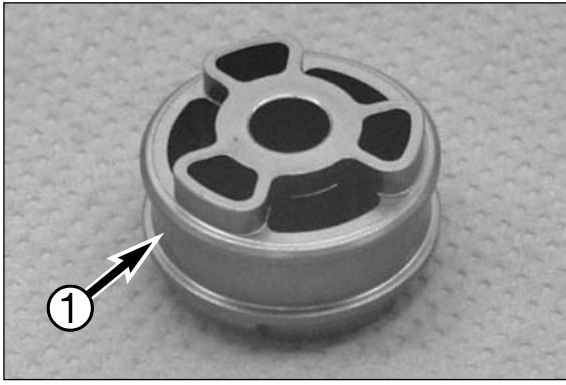

- Rebound piston, setting side ❶ shown!

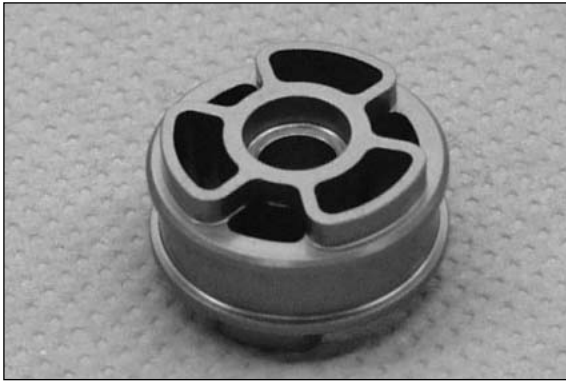

- Rebound piston, Check-valve setting side shown!



#### Inspection of the rebound setting

- Polish both sides of the rebound piston with sandpaper 600 on a flat plate.

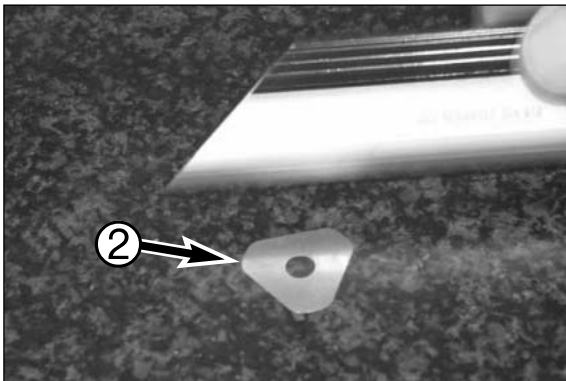

- Check the first shim ❷ of the rebound setting that is assembled on the rebound piston if it is not bended.
- If bended check the second shim and so on. Inspect also the check valve shim(s).
- Always replace bended shims!

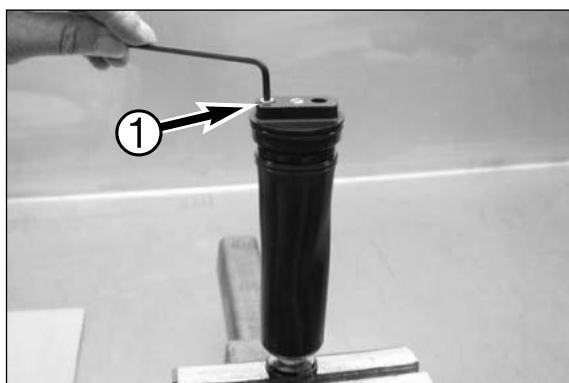

### Disassembling the screw-cap / membrane CC

- Place the screw cap / membrane CC in the vice according to the picture.
- Loosen the Allen bolt ❶, (Size 3)

NOTE: from model 2006 on a Phillips flat-head screw M4 is used.



- Remove the Allen bolt.

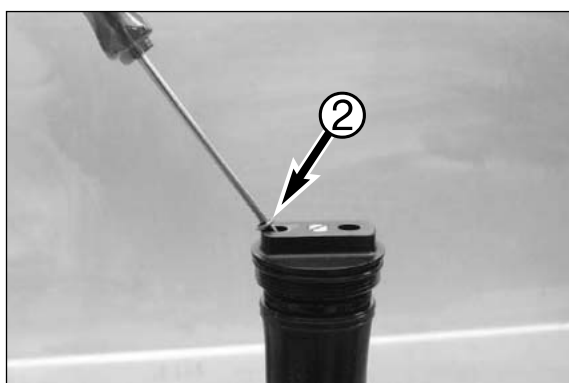

- Take the seal ❷ out of the screw-cap.

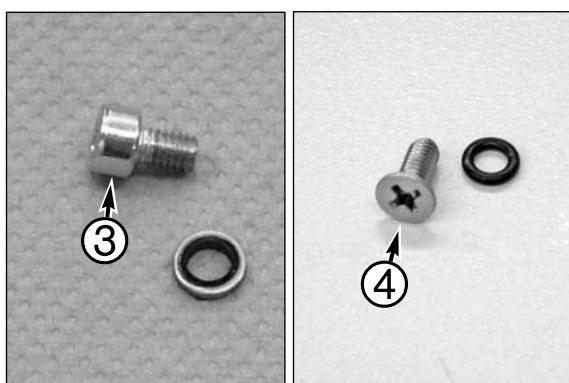

- Allen bolt ❸ with seal (2005).
- Phillips flat-head screw M4 ❹ with O-ring (from model 2006 on).

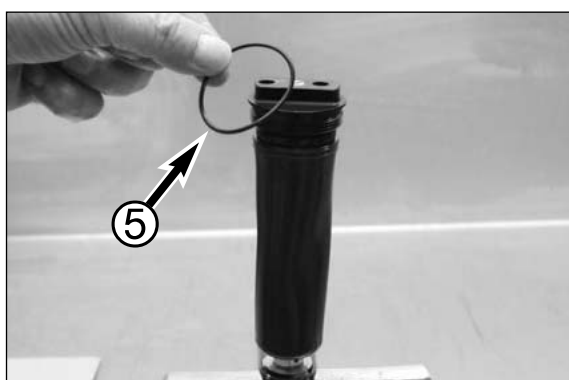

- Remove the O-ring ❺ out of the groove of the screw-cap.



**Disassembling model 2005**

- Place the screw-cap in the vice according to the picture.



- Loosen the tap compression **1**, (Size 17).

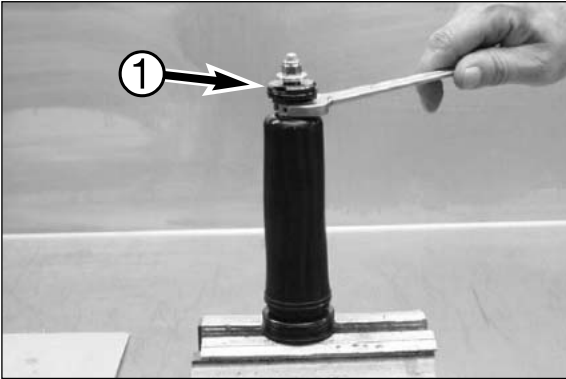

- Screw the tap compression out of the rod.



- Remove the the tap compression complete.

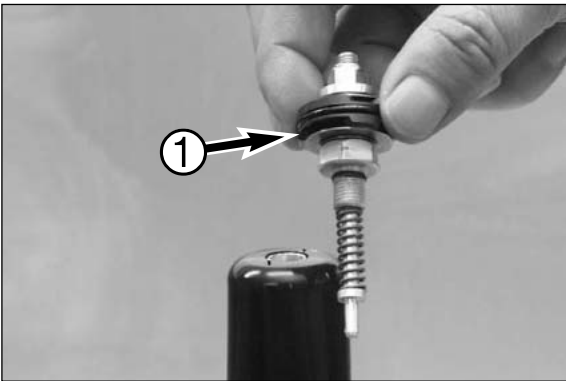

- Remove the adjustment tube **2**.

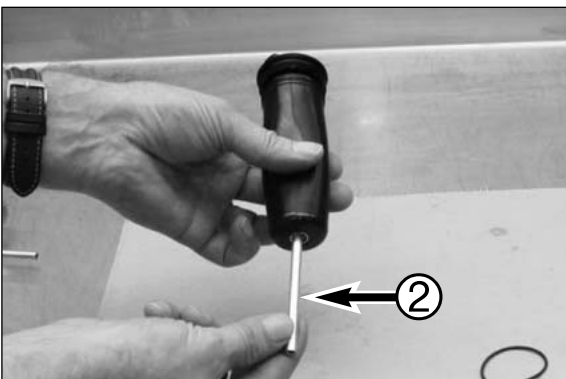

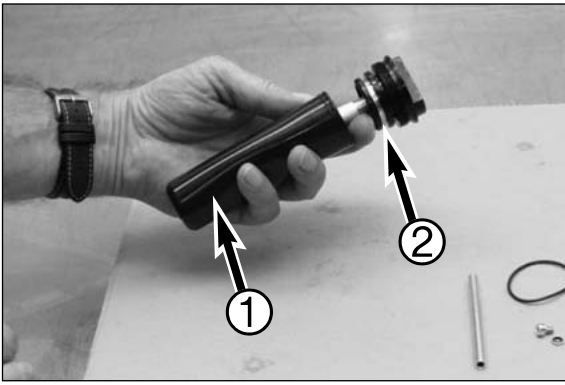

- Take the membrane ① out of the groove ② of the screw-cap.



- The screw-cap with the membrane CC with the components.



- Place the rod of the screw-cap in clamping-block T14.016.

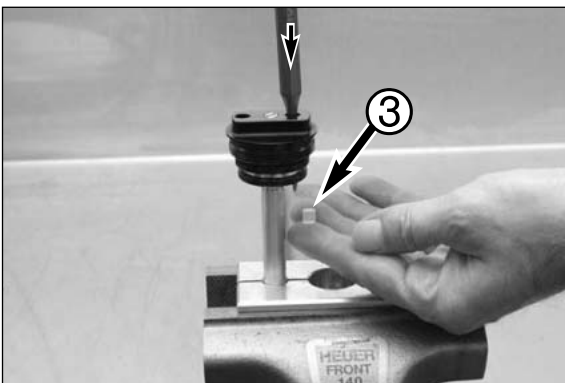

- Push the rubber plug ③ out of the screw-cap.



- Place the rod with screw-cap in the clamping-block according to the picture.

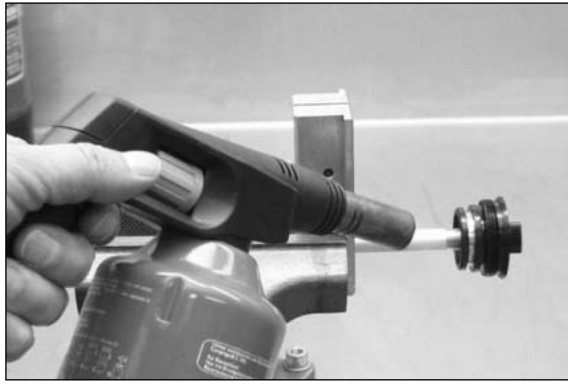

- Heat the screw-cap to a temperature of approx. 50°C near the rod.

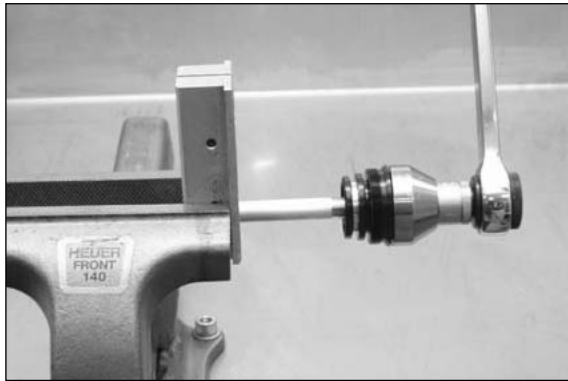

- Untighten the screw-cap with T14.018.

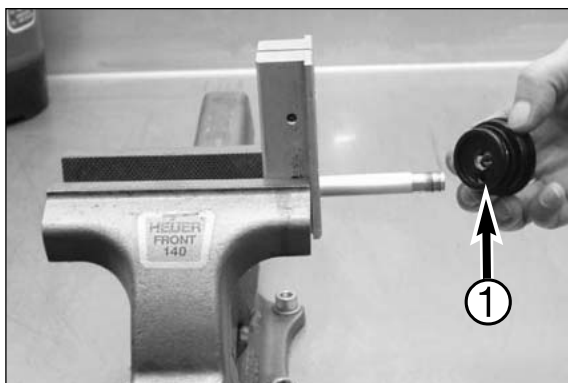

- Unscrew the screw-cap ① of the rod.

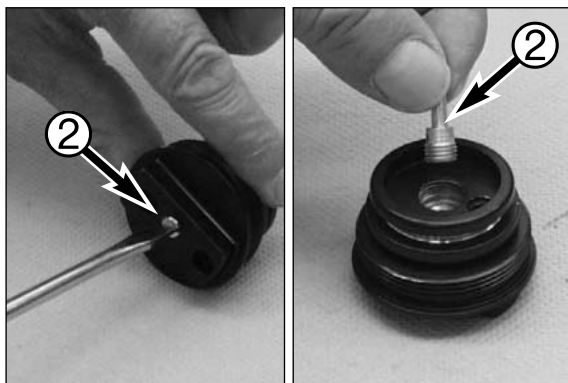

- Turn the adjustment screw ② fully clockwise and remove the adjustment needle.

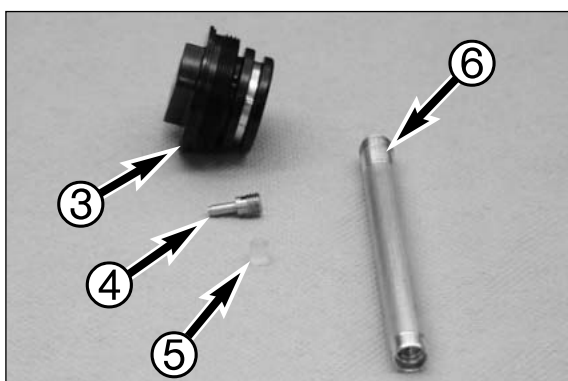

- Screw-cap ③
- Adjustment needle ④
- Rubber plug ⑤
- Rod ⑥

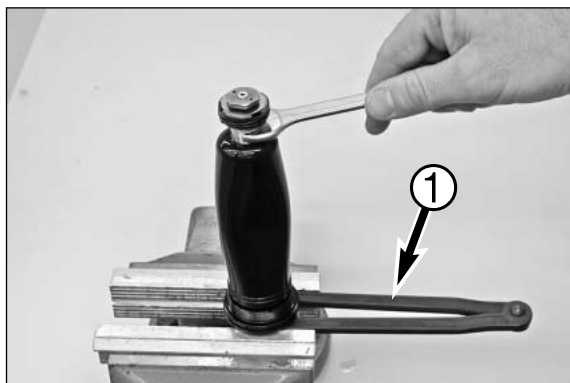
**Disassembling (from 2006 model on):**

- Hold the screw cap with T103 ① or clamp in a vise with T103 (see photo).

NOTE: tighten vise gently.

- Loosen the compression damping fixture ② (A/F 13).

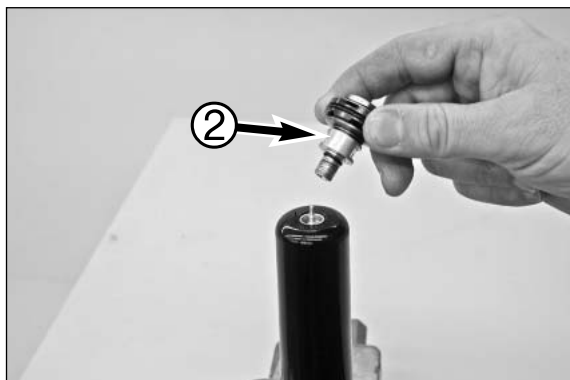

- Unscrew the compression damping fixture.

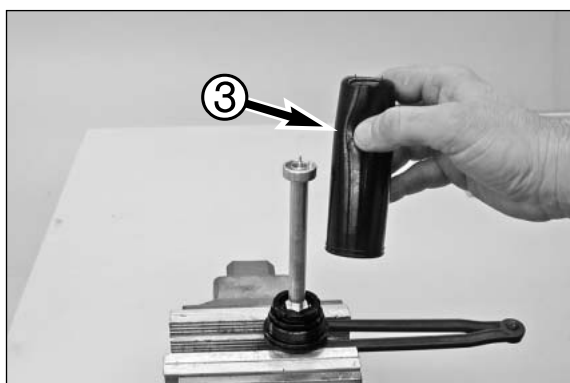

- Pull the membrane ③ out of the groove in the screw cap and remove.

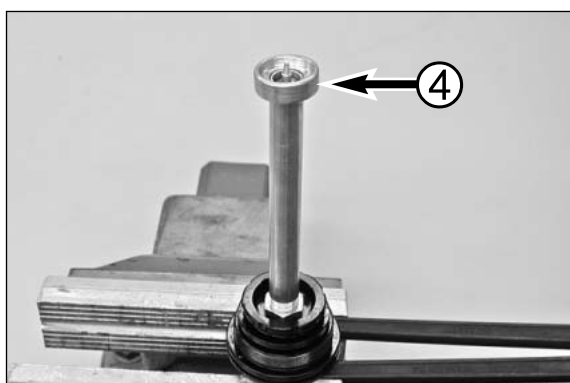

- Pull the clamping disk ④ off the piston rod.

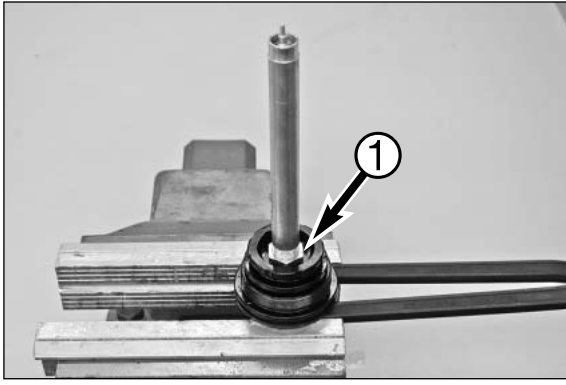

- Loosen the nut ❶ on the piston rod and screw a few turns away from the screw cap.
- Clamp the piston rod with T14.016S, heat the screw cap to approx. 50°C and unscrew with T103.

NOTE: the piston rod and screw cap come as a unit for SX models starting in 2007 and do not need to be disassembled.

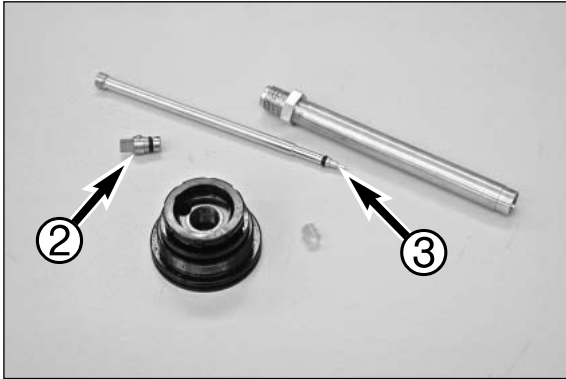

- Take the adjusting screw ❷ out of the piston rod, remove the O-ring.

NOTE: do not lose the two balls and the spring for the adjusting screw.

- Unscrew the needle on the compression damping adjustment ❸ from the piston rod, remove the O-ring.
- Press the rubber plug ❹ out of the screw cap.

**Assembly (2006 model onwards):**

NOTE: assemble in the reverse order. Apply T131 to the thread on the piston rod and the compression damping fixture. Replace all O-rings and the rubber plug in the screw cap; grease the O-rings with T158.

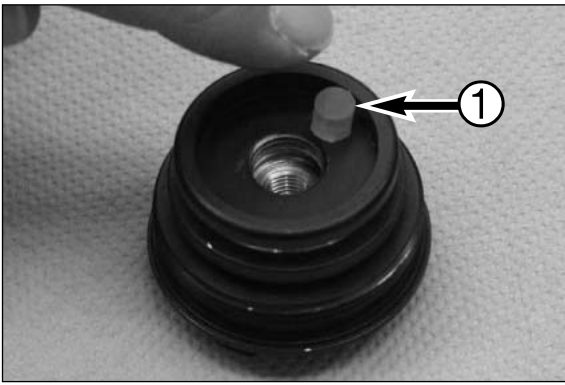

### Assembling the screw-cap/membrane CC

- Always assemble a new rubber plug when the rubber plug ❶ is removed out of the screwcap.

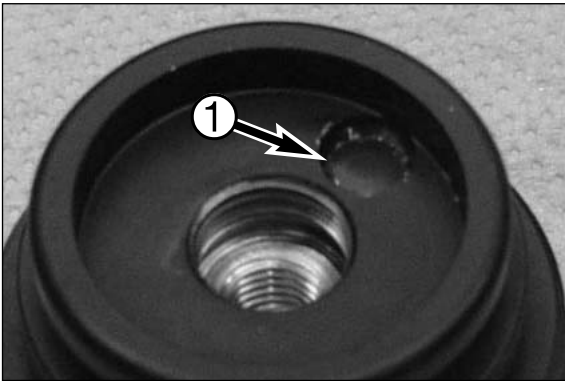

- Push the rubber plug ❶ as far as possible into the screw-cap.

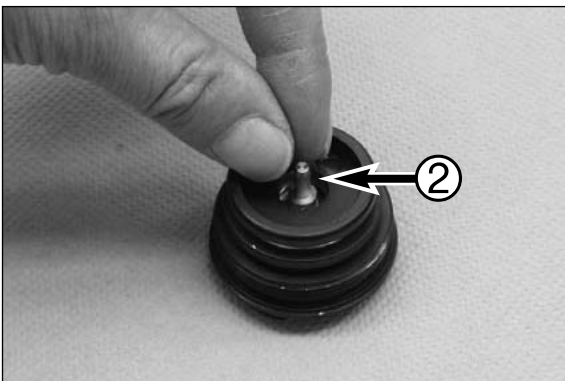

- Assemble the needle. ❷.



- Turn the adjustment screw anti-clockwise fully open.

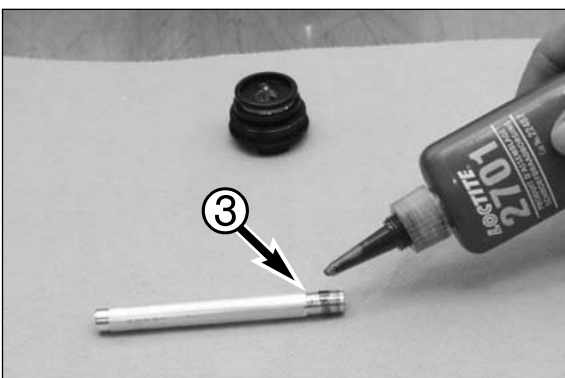

- Wet the thread of the rod ❸ with T132.

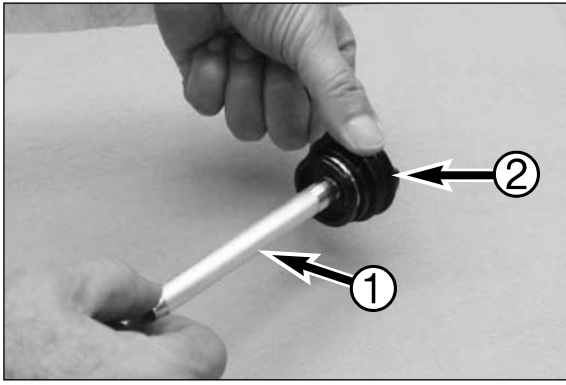

- Turn the rod ① in the screw-cap ②.

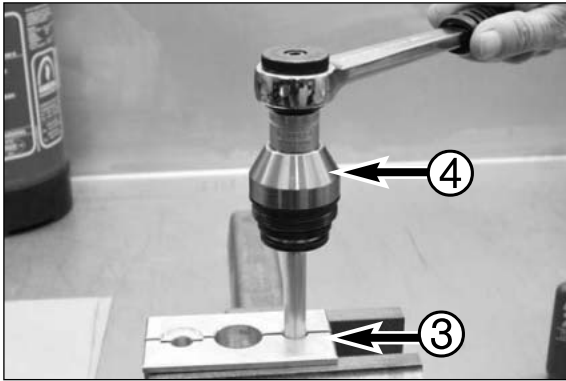

- Clamp the rod in the clamping-block T14.016 ③ and tighten the screw-cap with T14.018 ④.

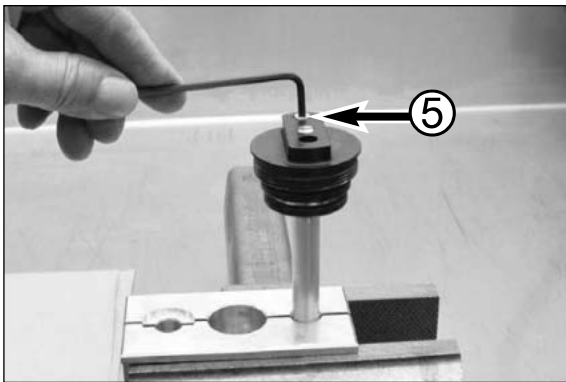

- Assemble the Allen bolt ⑤ with the seal.

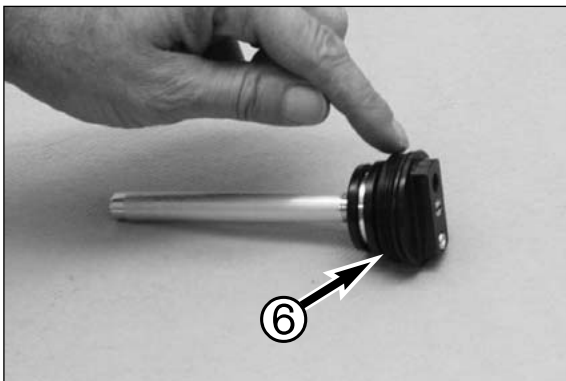

- Place the O-ring ⑥.



- Place the screw-cap in the vice according to the picture.

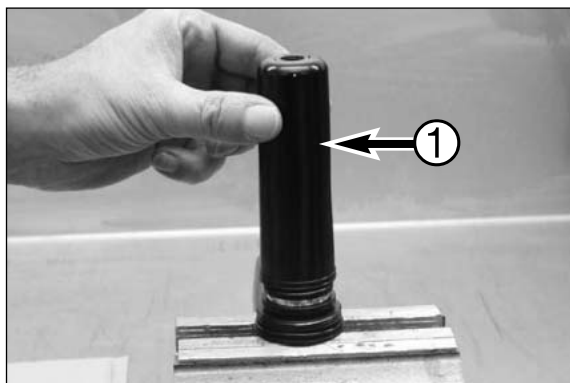

- Place the membrane ❶.



- Assemble the membrane in the groove of the screw-cap.



- Assemble the membrane over the rod ❷.



- The complete tap compression.

NOTE: the adjusting screw stays in the piston rod starting with the 2006 model. The following steps will not be necessary. Continue at the bottom of page 4-48.

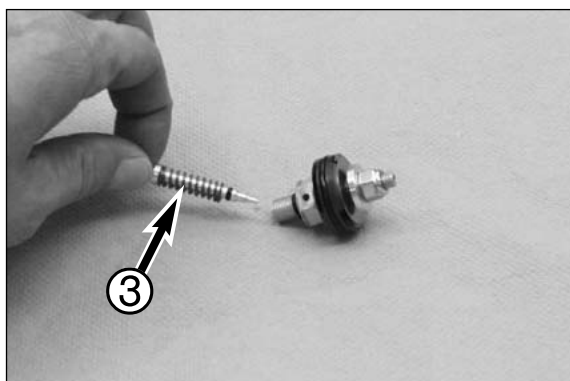

- Remove the adjustment needle ❸ with spring.





- Apply the thread with T131.

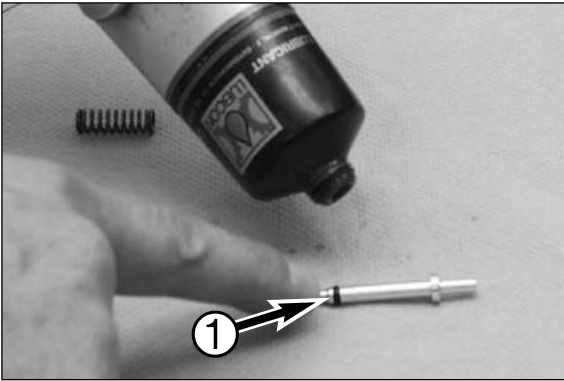

- Remove the spring from the needle.
- Grease the O-ring ① of the needle with T158.



- Replace the adjustment needle with the assembled spring into the tap compression.

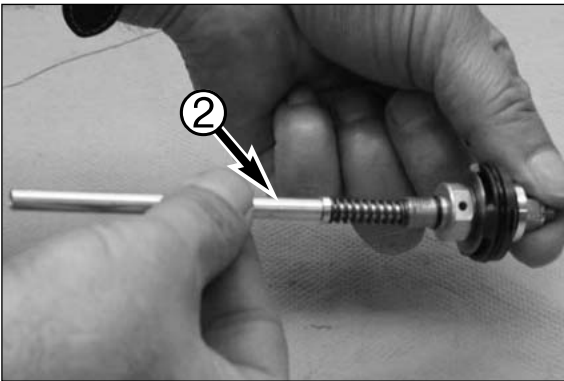

- Place the adjustment tube ② on the end of the needle.



- Place the compression unit in the vice according to the picture.

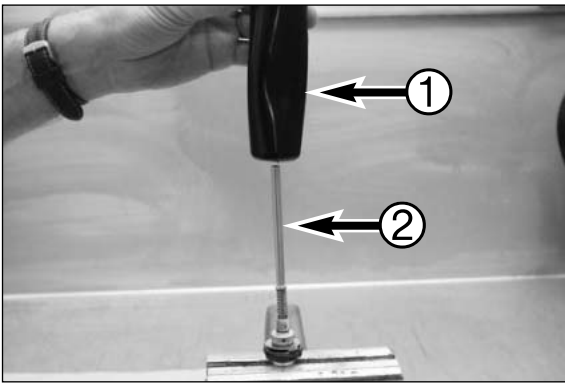

- Place the screw-cap with membrane CC ① over the adjustment tube ②.



- Screw the membrane on the tap compression.



- Place the screw-cap in the vice according to the picture.

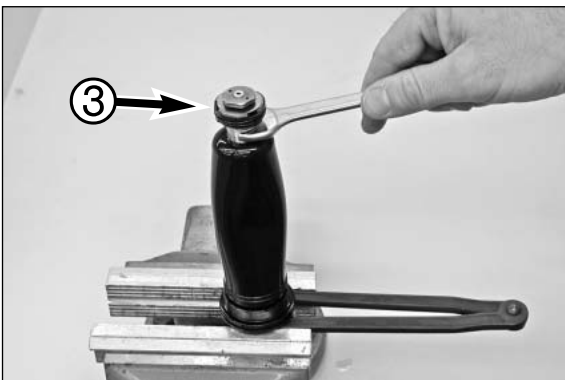

- Tighten the compression tap ③.

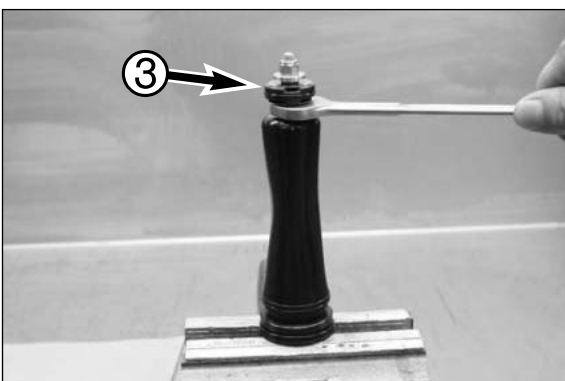

**Disassembling the tap compression**

- Unscrew the lock nut ❶, (Size 10).

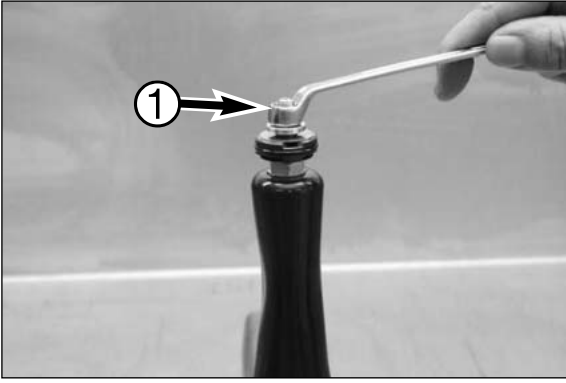

up to the 2005 model:

- Remove the lock nut ❶.

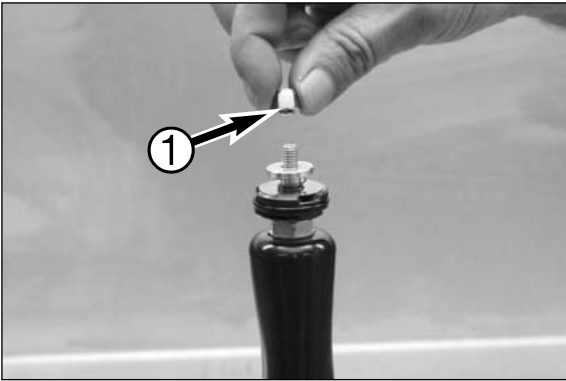

- Take off the shuttle valve ❷.
- Take off the check-valve spring ❸.

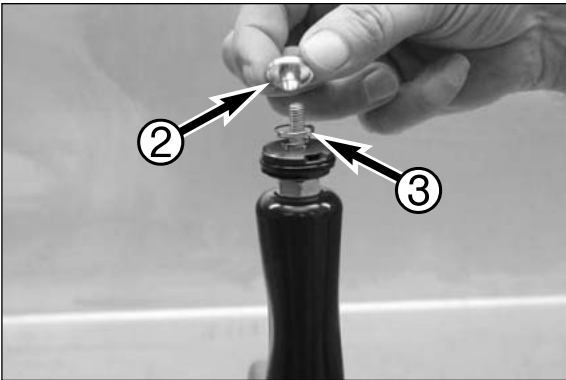

starting with the 2006 model:

- Remove the lock nut ❷.
- Remove the check valve spring ❸ and check valve ❹.

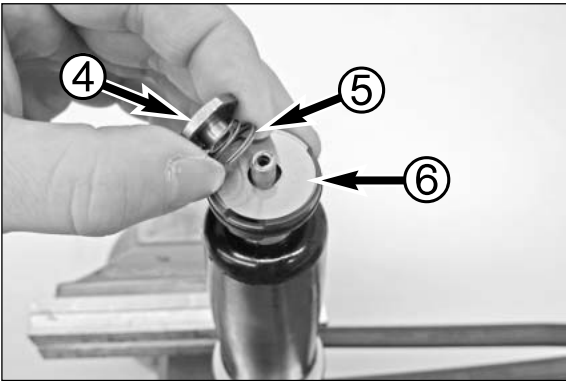

- Place a screwdriver on top of the tap.



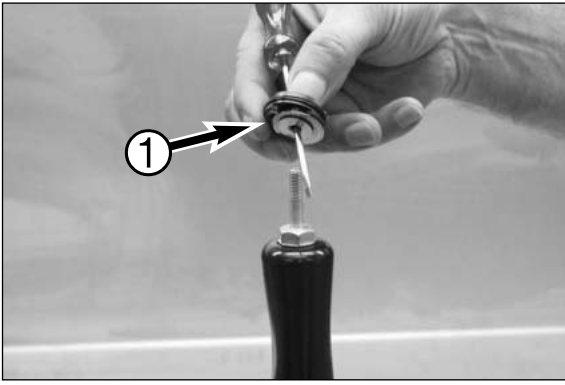

- Slide the complete compression setting ❶ over the shaft of the screwdriver.

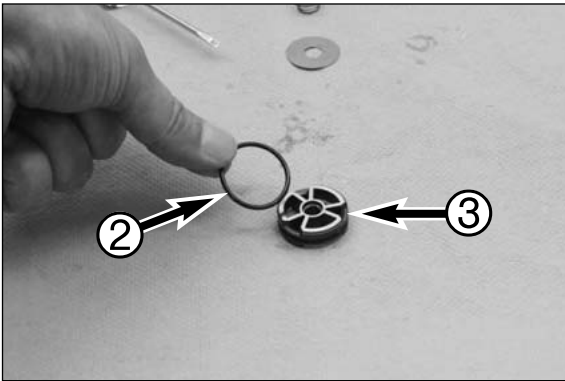

- Disassemble the O-ring ❷ of the compression piston ❸.

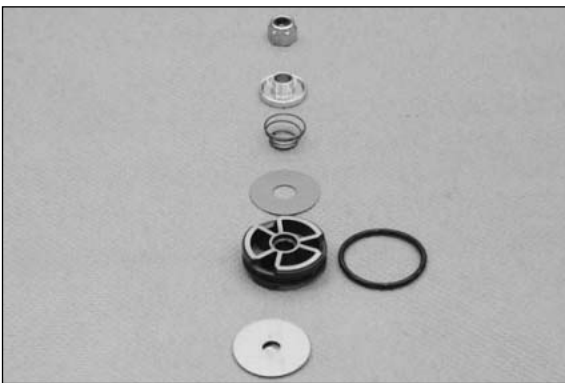

- Compression setting with the components.

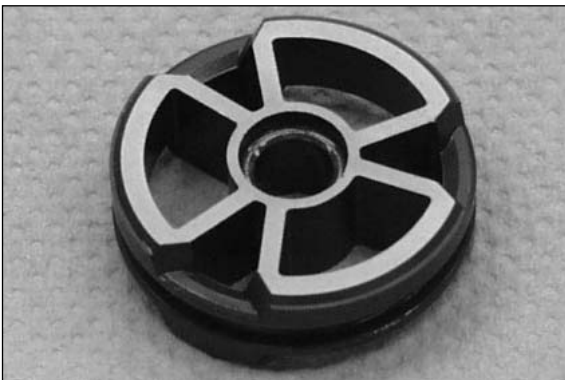

- Compression piston, check-valve setting side shown.



- Compression piston, setting side shown.

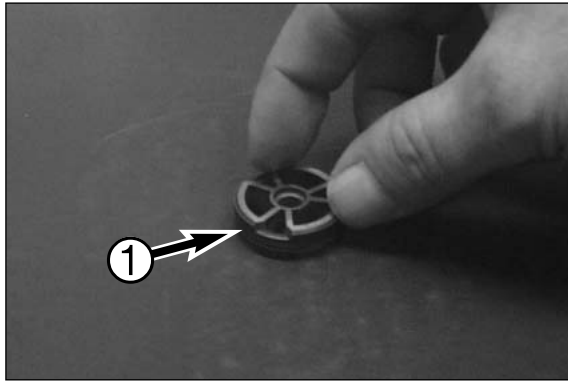

### Inspection of the compression setting

- Polish both sides of the compression piston ① with sandpaper 600 on a flat plate.

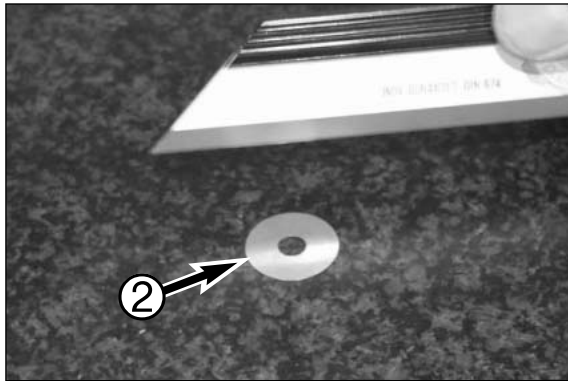

- Check the first shim ② of the compression setting that is assembled on the compression piston if it is not bended.
- If bended check the second shim and so on. Inspect also the check valve shim(s).
- Always replace bended shims!

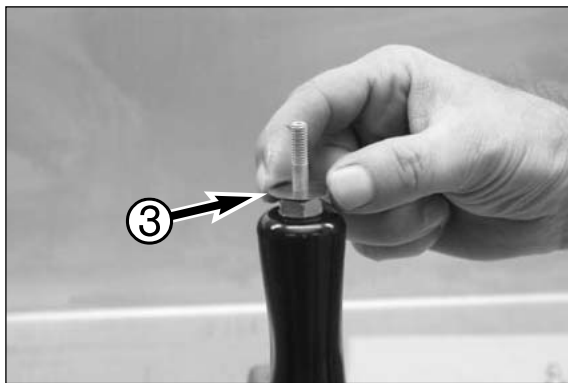

### Assembling the tap compression

- Place the complete compression shim setting ③ on the tap compression.

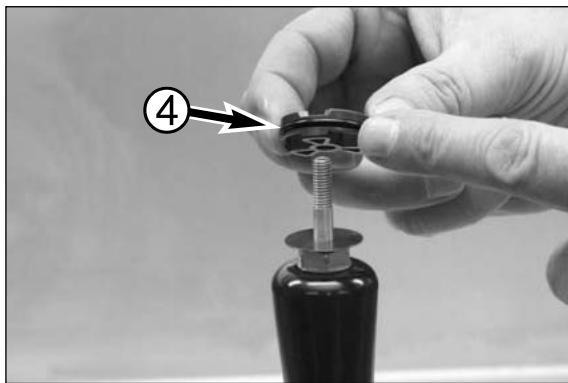

- Place the O-ring ④ in the groove of the compression piston.



- Place the compression piston on the tap.



up to the 2005 model:

- Place the compression check-valve setting ❶.

- Place the check-valve spring ❷.

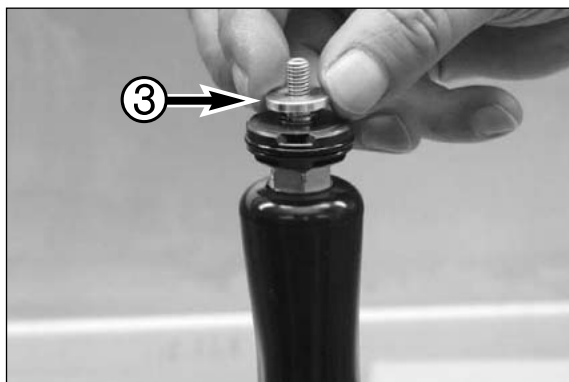

- Place the shuttle valve ❸.

NOTE: Assure that the check-valve shim(s) is fitting over the shuttle valve!



- Screw a new lock nut ❹ on the compression tap.

- Tighten the lock nut to a torque of 6 Nm.

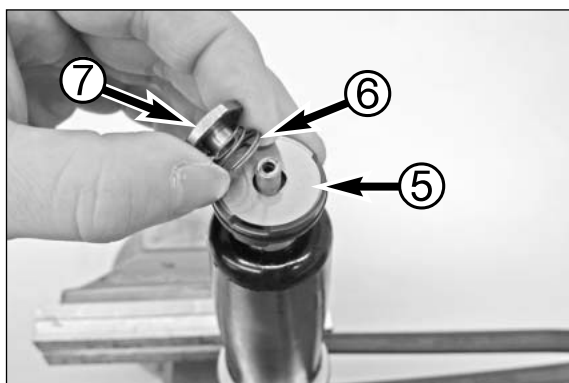

starting with the 2006 model:

- Mount the check valve ❺ and the check valve spring ❻.

NOTE:

- the check valve spring must be mounted with the smaller diameter of the coil facing up.

- Center the check valve and check valve spring with the collar on the lock nut.

- Mount the lock nut ❼ and tighten to 3 Nm.

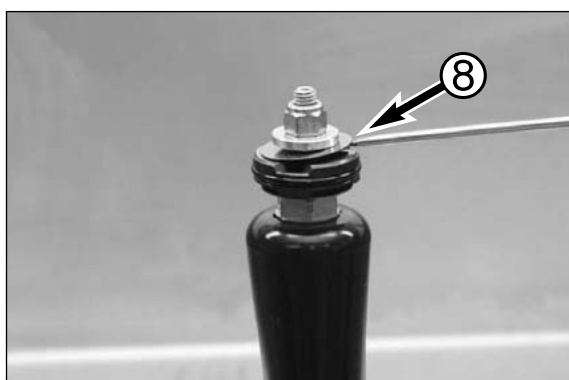

- Assure that the check-valve ❸ is functioning.

**Assembling the holder membrane**

- Blow with high air pressure through the valve ❶.

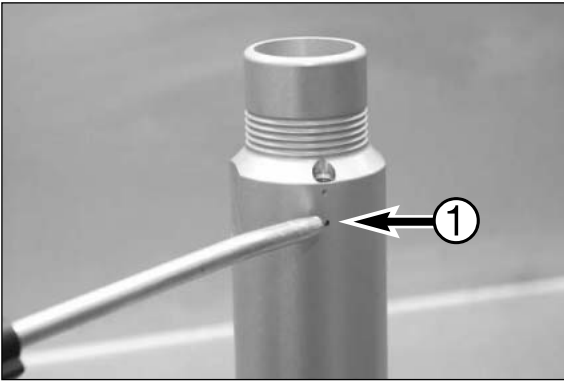

- Blow with high air pressure through the other side of the valve.

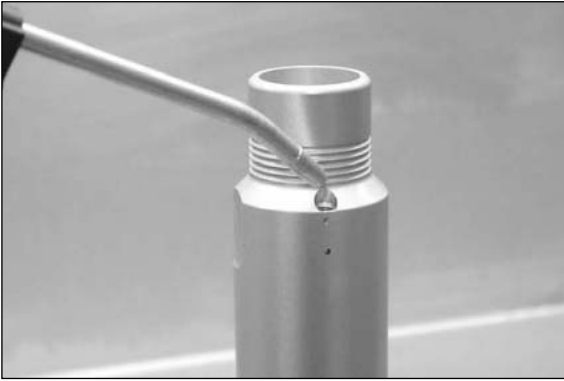

- Place the valve spring ❷.

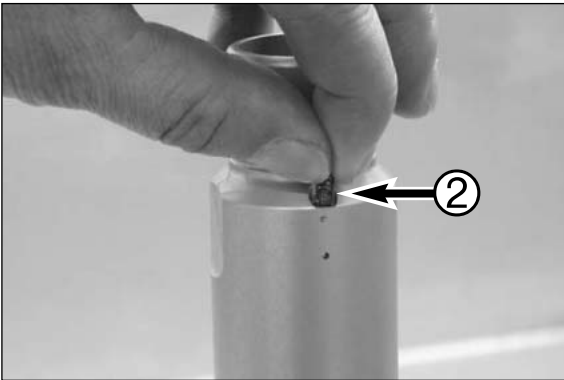

- Turn the adjustment screw at the level of the edge of the hole. ❸.

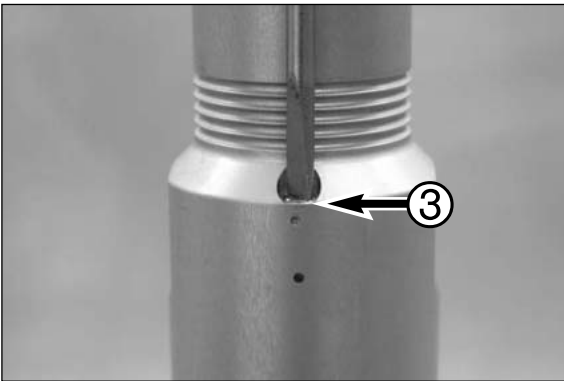

- Adjust with one complete turn (clockwise) the adjustment screw

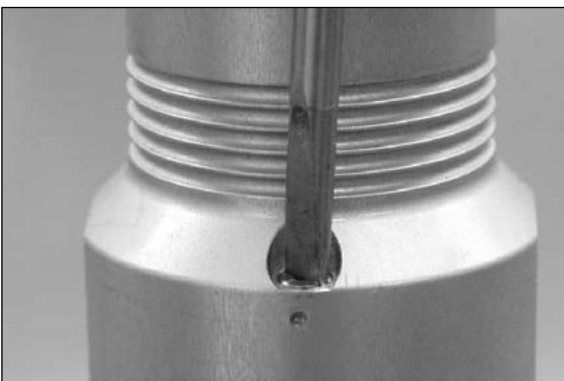



- Assemble the O-ring ① in the groove inside the membrane holder.

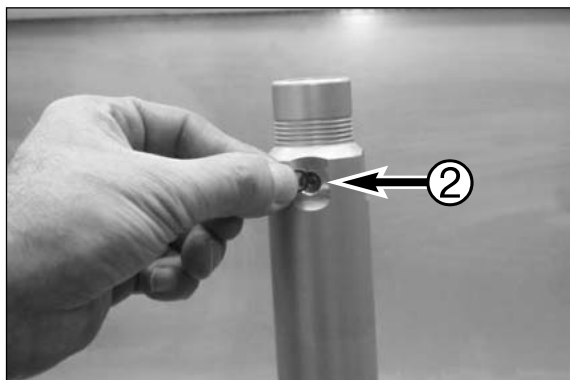

- Place the O-ring ②.

NOTE: the filling screw is in this position starting with the 2007 model. Do not mount yet.

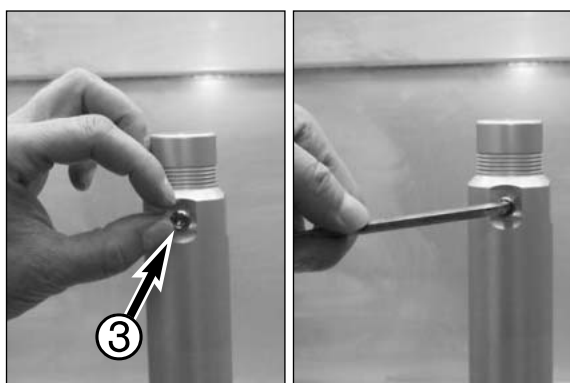

- Screw the plug ③ in the holder and tighten the plug.

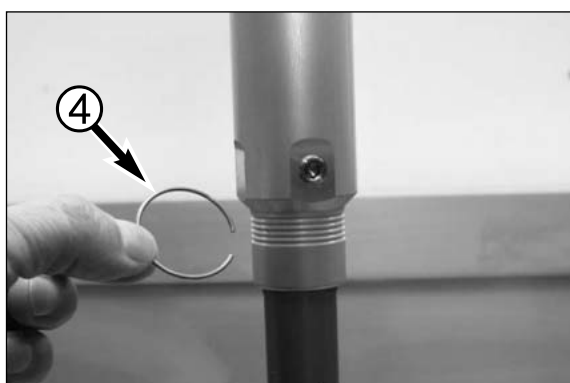

- Assemble the spring ring ④ in the groove as noticed before.

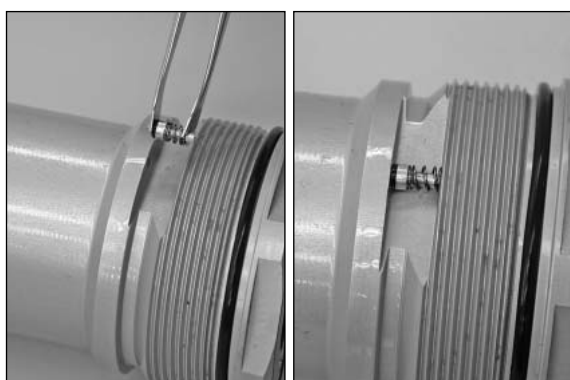

Check valve SX/SXS 2007:

- Squeeze the control valve with spring and O-ring together with T 14033, move the control valve into position.
- Check the control valve and O-ring for a proper fit.



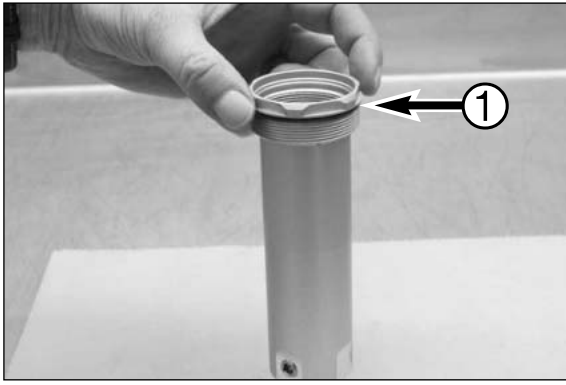

– Assemble the O-ring ①.



– Apply the O-ring with T158.

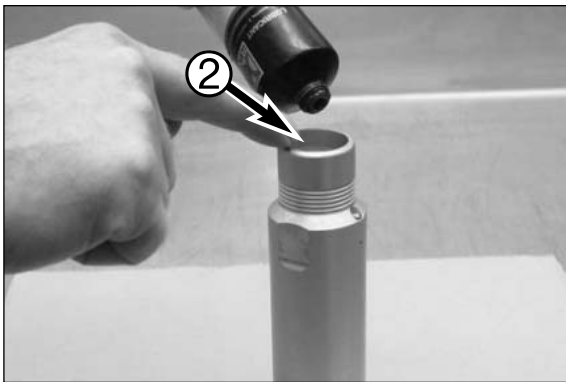

– Apply the inside O-ring ② with T158.



– Membrane holder complete.

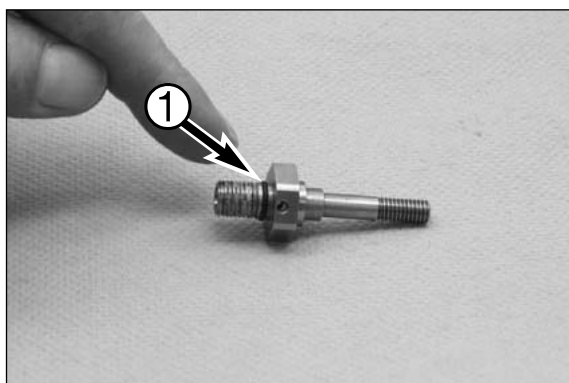

### Assembling the tap rebound

- Place a new O-ring ①.

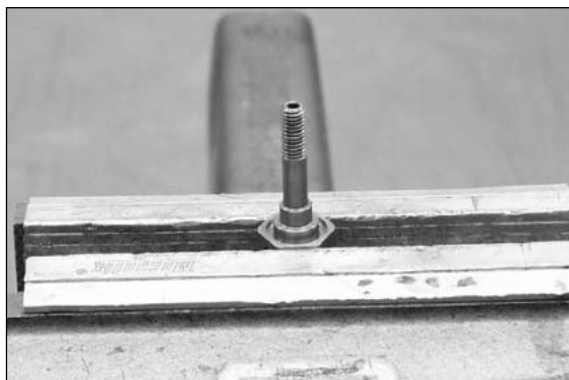

- Place the tap rebound in the vice.

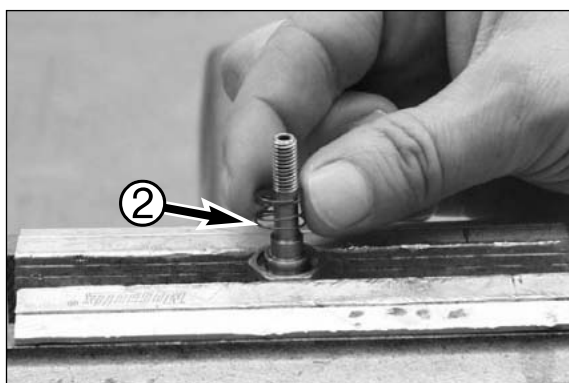

- Place the check-valve spring ②.

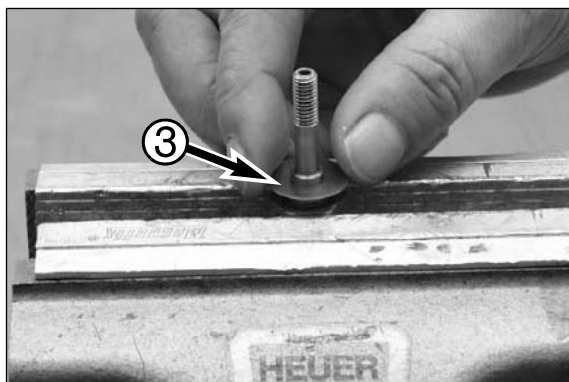

- Place the check-valve setting ③.

NOTE: the disks must be pressed down against the spring force; they are centered by the collar.

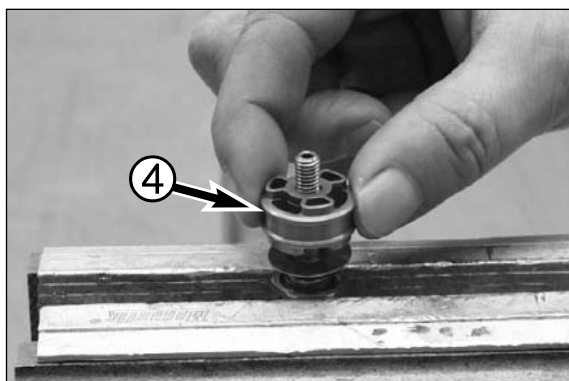

- Place the rebound piston ④.

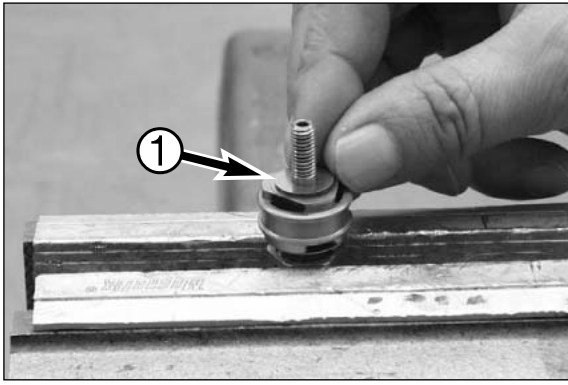

- Place the shim setting **1**.

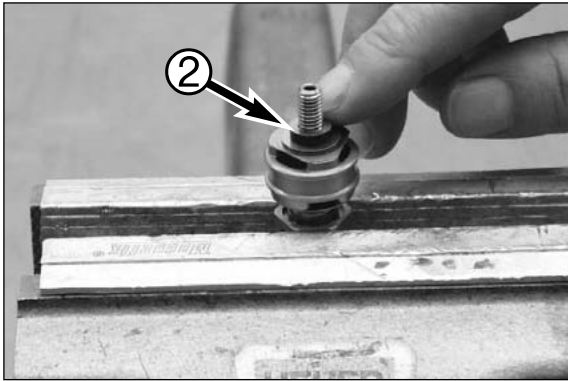

- Place the bush **2**.

NOTE: a nut with a collar is used instead of a bushing starting in 2007. Mount with the collar facing the disks and lock the thread with T131.

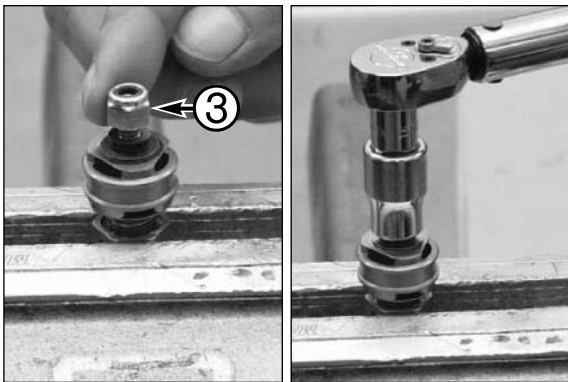

- Screw a new lock nut **3** on the tap (up to the 2006 model).
- Tighten the nut to a torque of 5 Nm.

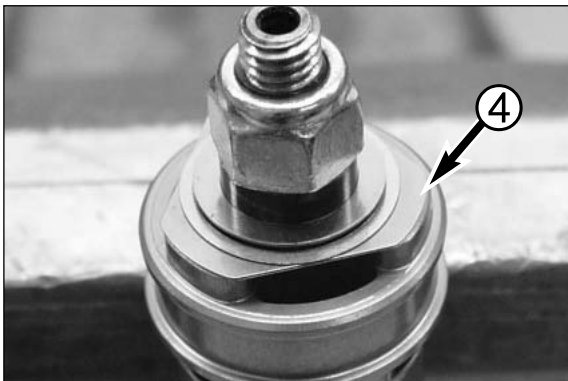

NOTE: Pay attention to the position of the triangular shims **4** on the rebound piston!

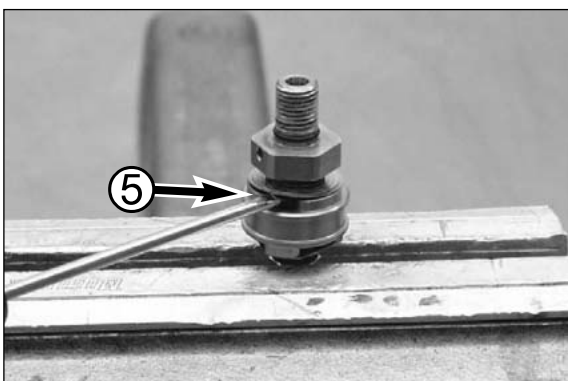

- Check the functioning of the check-valve **5**.

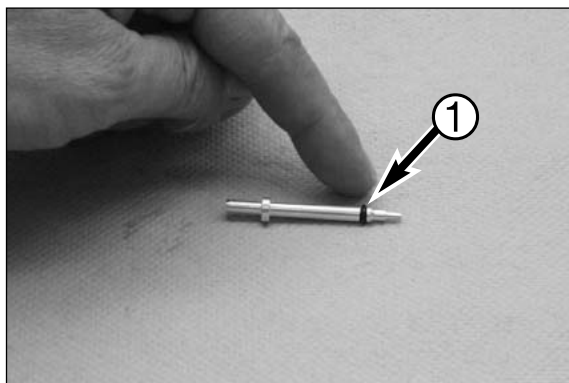

– Place the O-ring ❶.

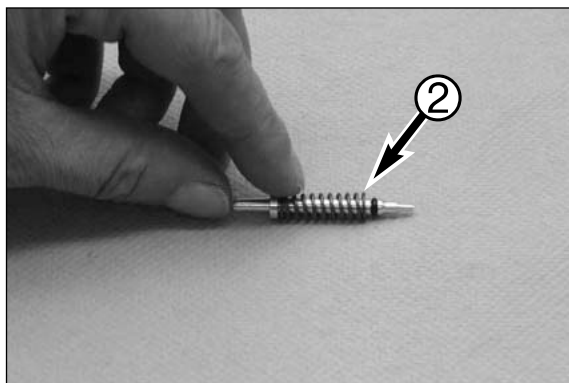

– Place the spring ❷.



– Grease the O-ring with T158.



– Assemble the adjustment needle in the tap rebound.



**Assembling the rebound adjustment adaptor**

- Place a new O-ring in the adaptor.

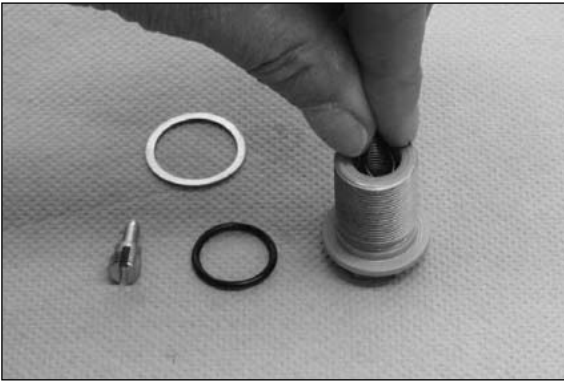

- Assemble the O-ring in the groove inside the adaptor.

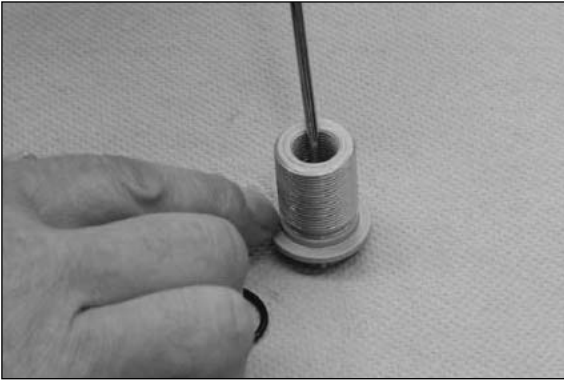

- Assemble the needle ❶.

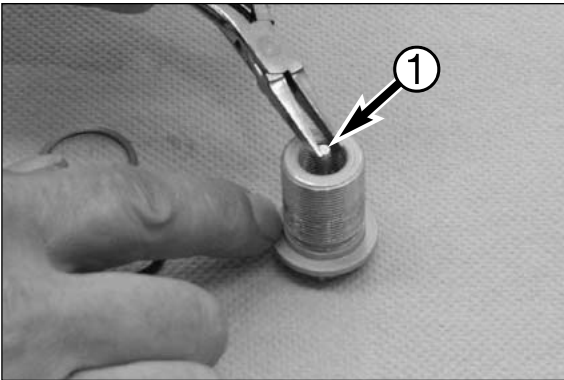

- Turn the adjustment screw ❷ anti-clockwise fully open.

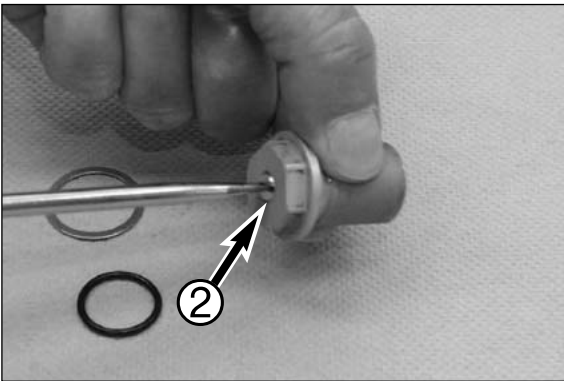

- Place a new copper washer ❸.

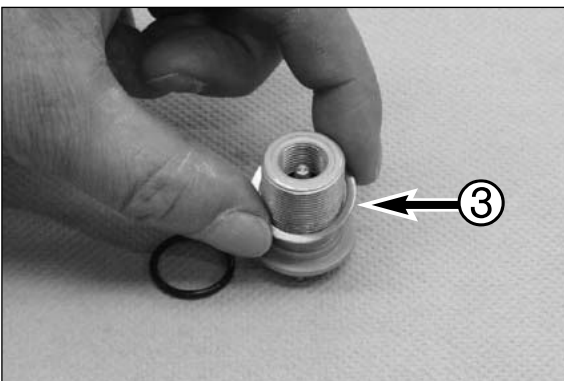

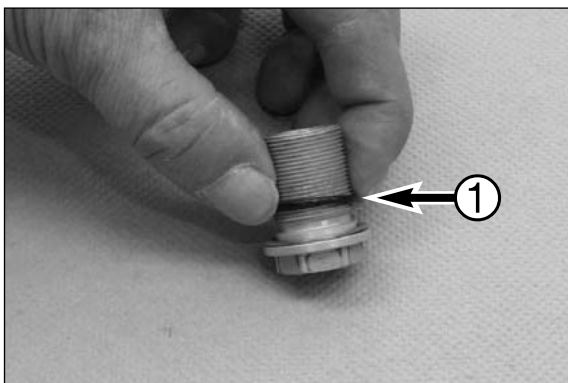

- Assemble the O-ring ① in the groove.



- Rebound adjustment adaptor complete.

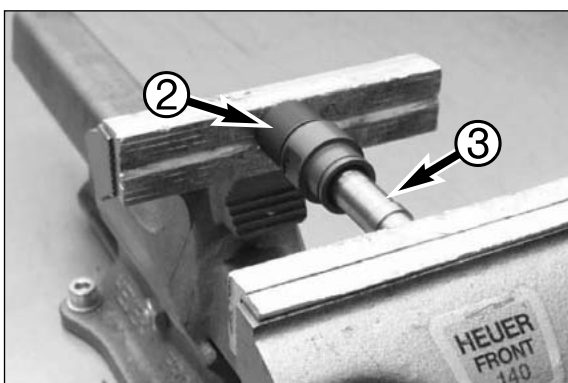

#### Assembling the screw sleeve

- Screw T14.023 ② on the screw sleeve and then press in the new guide bush with T14.022 ③.

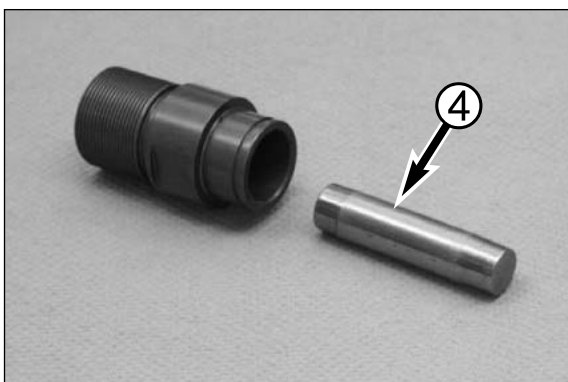

- Apply the calibrate mandrel T14.021 ④ with front fork oil.

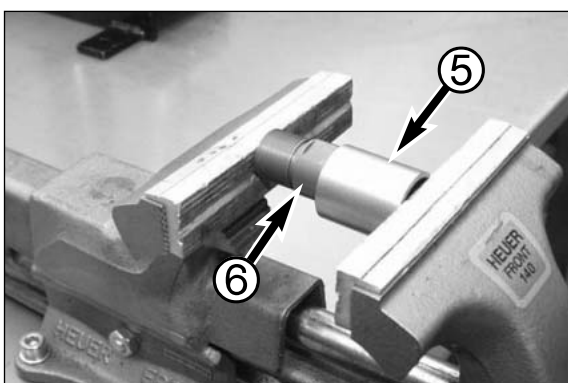

- Use T 14.024 ⑤ to press T 14.021 completely through the guide bush ⑥.

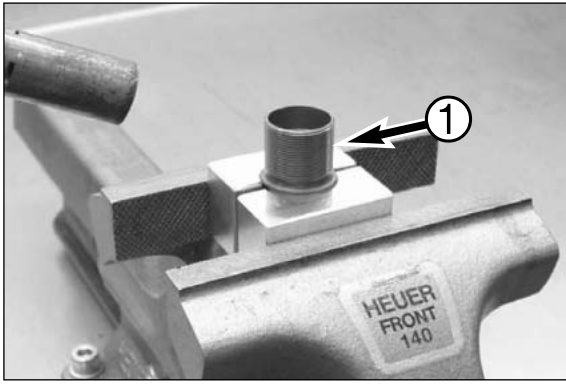

- Place the screw-sleeve ① in the clamping block and heat the screw sleeve to a temperature of approx. 50°C.

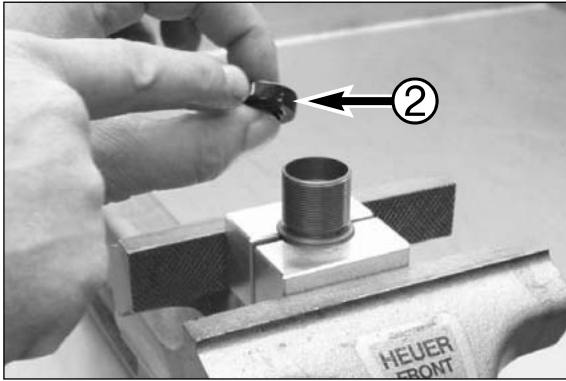

- Apply the outside of the new oil seal ② with front fork oil.

! **CAUTION** !

Do NOT MOUNT THE OIL GASKET YET FOR FORKS STARTING WITH THE 2006 MODEL. IT WILL BE MOUNTED DURING ASSEMBLY.

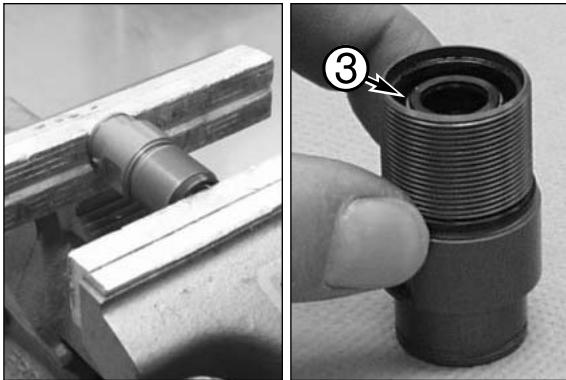

NOTE: Pay attention to the assembling direction!

- Press the oil seal ③ into the screw sleeve with T14.025. (not on picture)

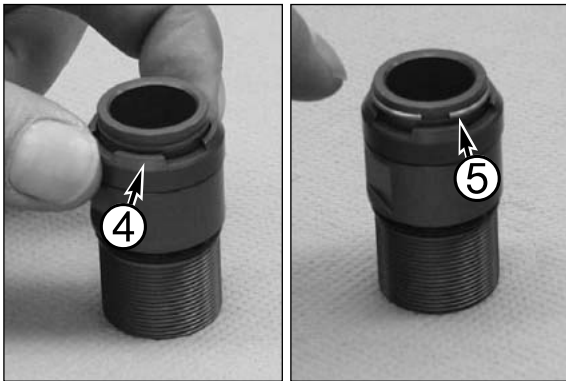

- Place the check-valve ring ④.
- Assemble the spring ring ⑤.

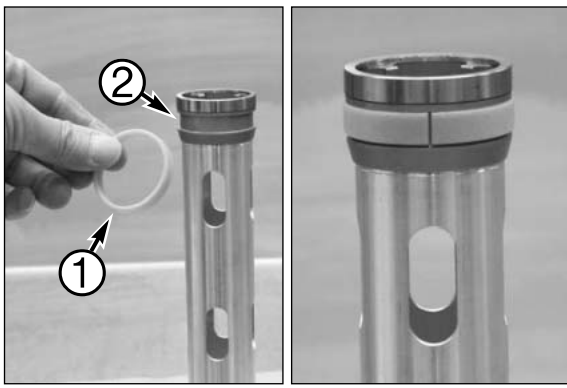

### Assembling the closed cartridge (Model 2005)

- Assemble the guiding ring ① in the groove ② of the tube.



- Tube complete.

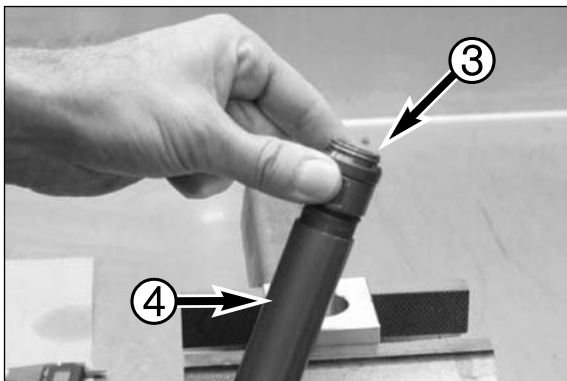

- Screw the screw sleeve ③ in the tube ④ completely.



- Wet the thread of the tube with T132.

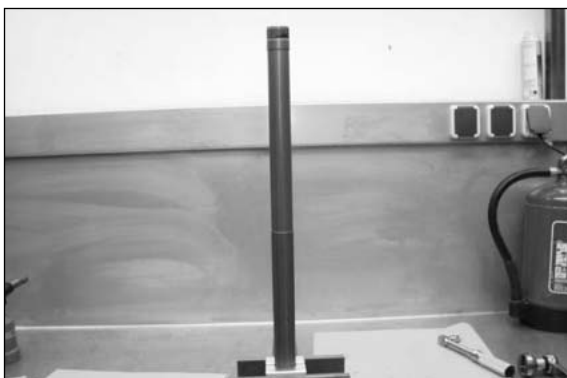

- Clamp the tube in the clamping-block T14.015.



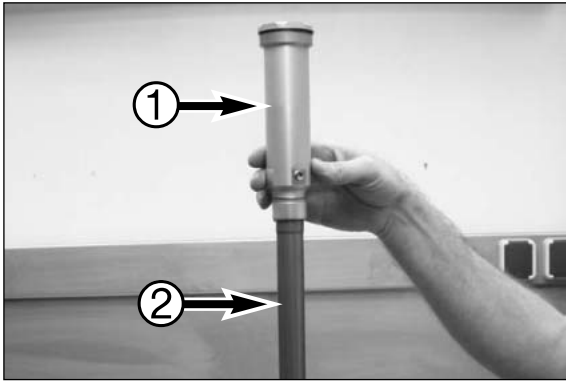

- Screw the membrane holder ① on the tube ②.

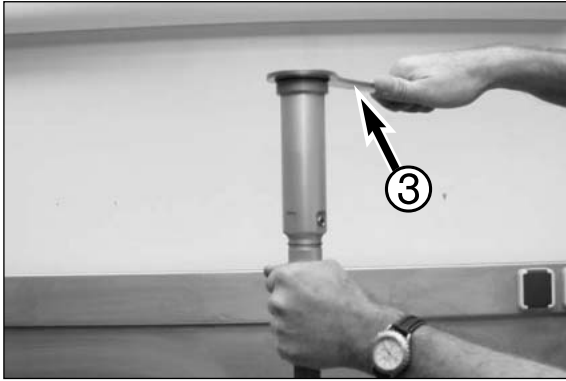

- Tighten the membrane holder with T14.017 ③.

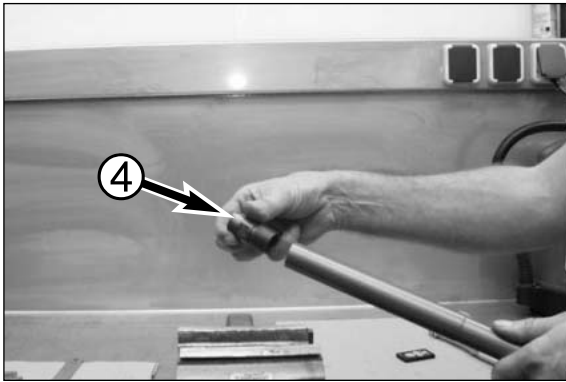

- Unscrew the screw sleeve ④ out of the tube.

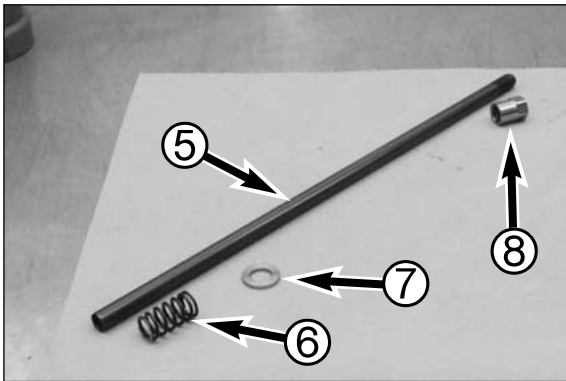

- Piston rod ⑤
- Rebound spring ⑥
- Washer ⑦
- Contra nut ⑧

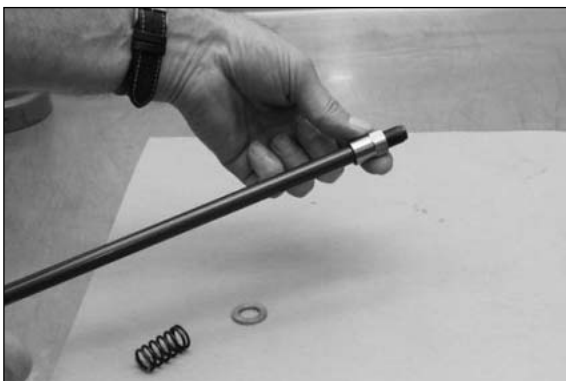

- Screw the contra nut to the end of the thread of the piston rod.

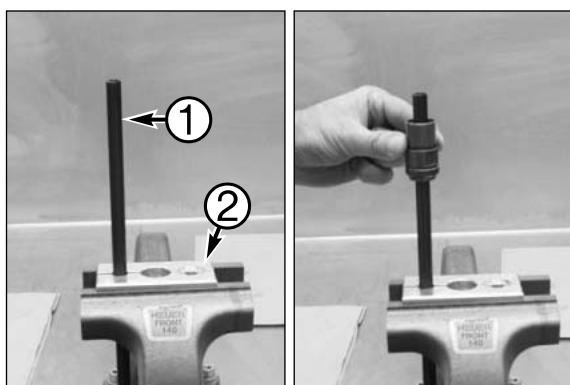

- Place the piston rod ❶ in the clamping block T14.016 ❷.
- Slide carefully the screw sleeve over the piston rod.

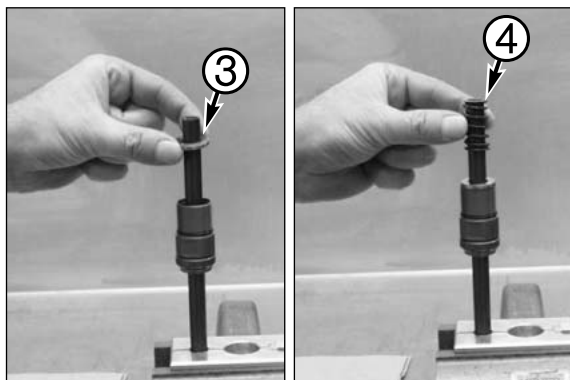

- Place the washer ❸.
- Assemble the rebound spring ❹.

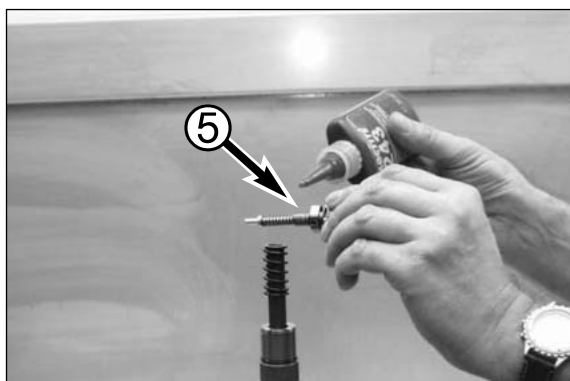

- Wet the thread of the tap rebound with T131 ❺.

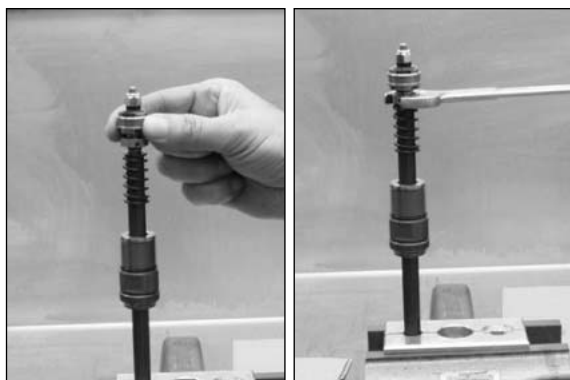

- Screw the tap rebound in the piston rod.
- Tighten the tap rebound.



- Slide the tube on the tube of the cartridge. Pay attention to the assembling direction!

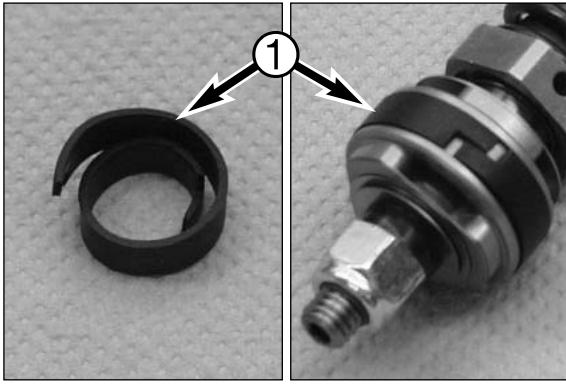

- Piston ring ❶, always place a new piston ring!
- Roll the piston ring over the shaft of a screwdriver!
- Place the piston ring in the groove of the rebound piston.



- Assemble carefully and slowly the piston into the tube of the cartridge.

NOTE: make sure the piston ring stays in position!



- Wet the thread of the screw sleeve with T131.

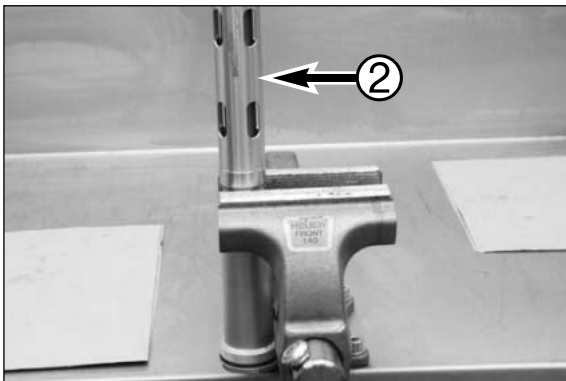

- Place the membrane holder ❷ in the vice according to the picture.



- Tighten the screw sleeve.

**Assembling the closed cartridge (starting with the 2006 model)**

- Assemble the guiding ring **1** in the groove **2** of the tube (SXS) or the guiding ring adapters (SX).

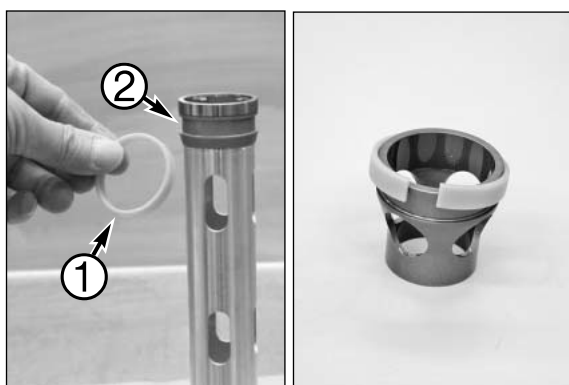

- Clamp the piston rod **3** with T14.016S **4** (inner thread facing up).
- Slide on the rebound spring **5** with spring guiding.
- Apply T131 to the thread on the rebound support **6**, screw the rebound support in the piston rod and tighten. Unclamp the piston rod again.

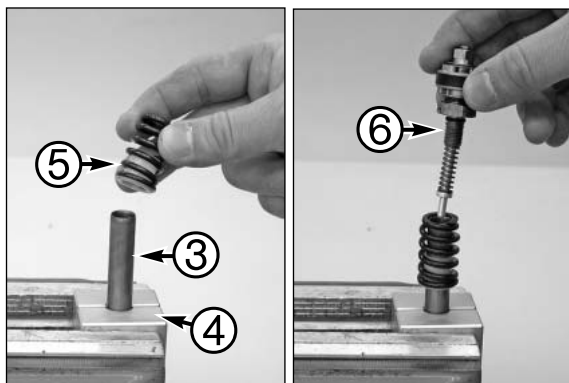
**SXS:**

- Slide on the tube **7**.

**SX:**

- Mount the lock ring **8**. Slide on the support ring **9** and guiding ring adapter **10**.

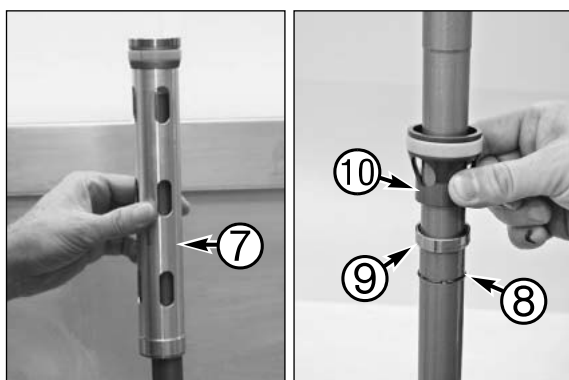

- Clamp the tube/membrane holder, do not clamp too tightly.



- Wrap the rebound damping piston ring over a screwdriver shaft.

NOTE: always replace the piston ring.

- Mount the piston ring in the groove.



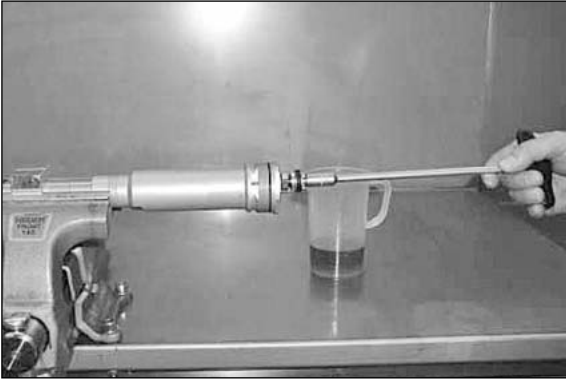

- Oil the piston ring.
- Slide the piston rod into the pipe, use a T-type wrench (10 mm) to center if necessary.

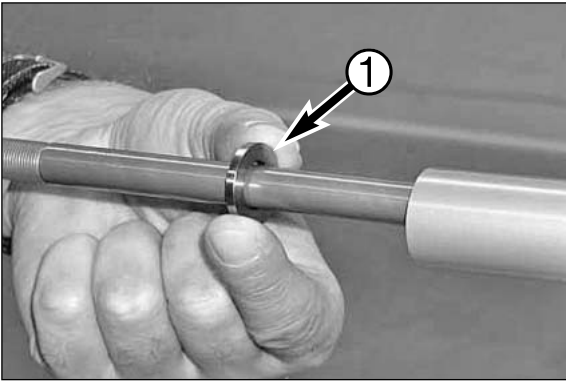

- Slide on the washer ①.

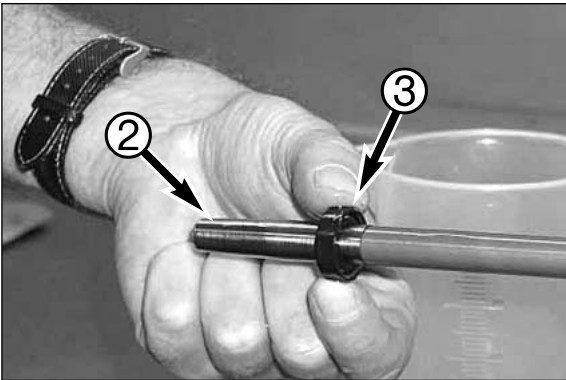

- Slide the special tool T 14.029 ② over the thread in the piston rod.
- Oil the seal ring ③ and slip on the piston rod, open end first, remove T 14.029.

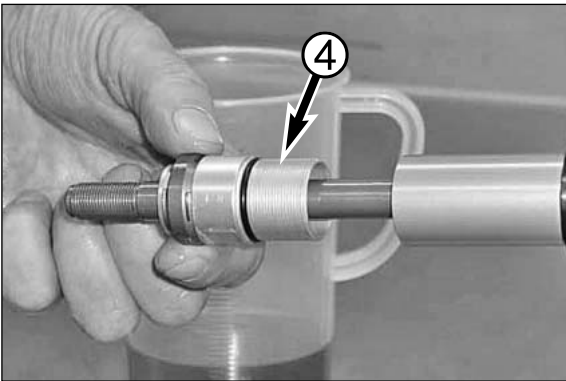

- Slide the screw bushing ④ on the piston rod.

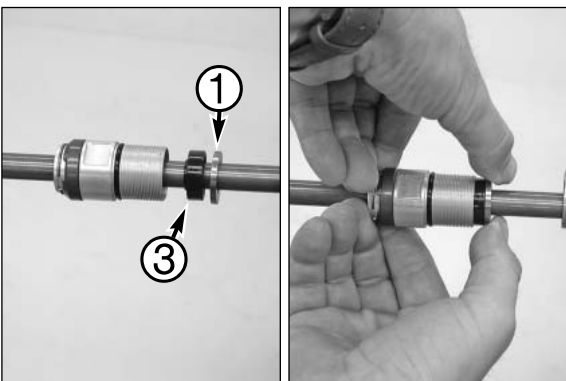

- Press the seal ring ③ into the screw bushing, using the washer as a pad if necessary.

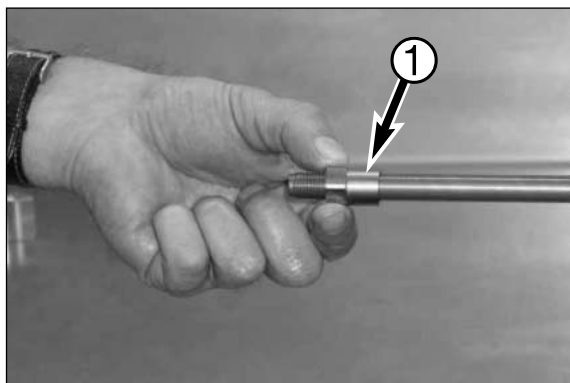

- Screw the locknut ❶ on the piston rod.

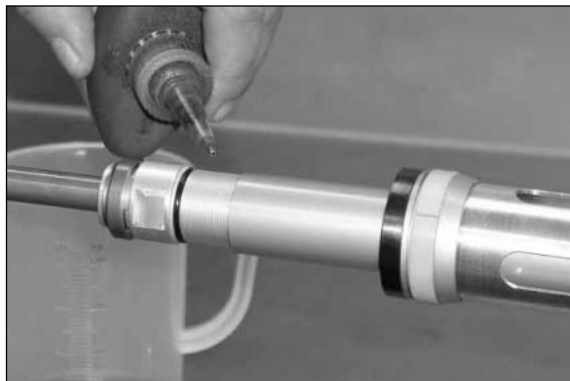

- Apply T 131 to the screw bushing.



- Screw on the screw bushing.

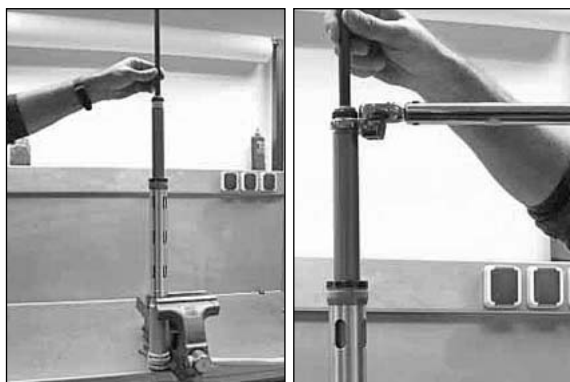

- Clamp the cartridge as shown in the photo and tighten the screw bushing to 40 Nm.

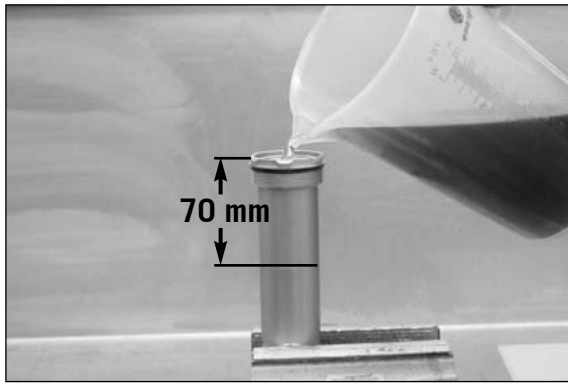

### Bleeding the closed cartridge (model 2005)

- Place the membrane holder in the vice according to the picture.
- Drain slowly front fork oil in the closed cartridge. The oil level must be about 70 mm from the top of the membrane holder. The piston rod must be fully extended!

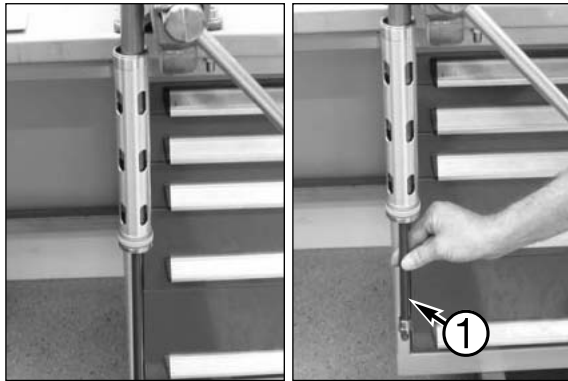

- Slowly move the piston rod ① several times the up and down.

NOTE: Be sure that all air is out of the oil, this can take several minutes!

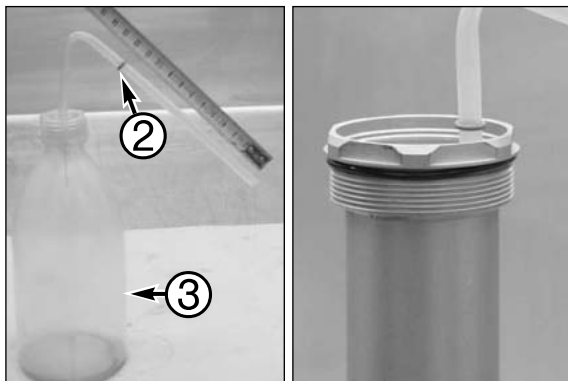

- Adjust the O-ring ② of the squeeze bottle T137S ③ to 120 mm.
- Adjust the oil level in the membrane holder to 120 mm, by keeping the O-ring of the squeeze bottle at the top level of the membrane holder.

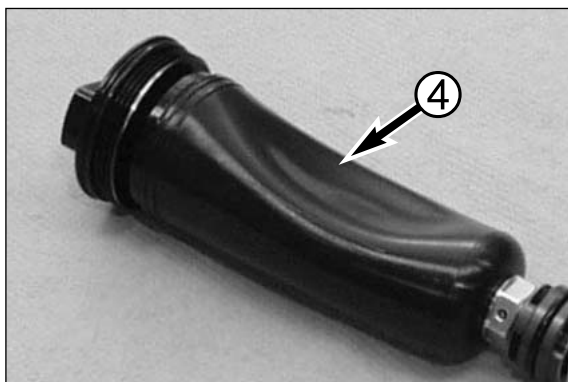

- If the membrane ④ has not the correct shape (see picture) open the membrane at the groove of the screw cap and press with a little bit of air pressure the membrane to the correct shape.



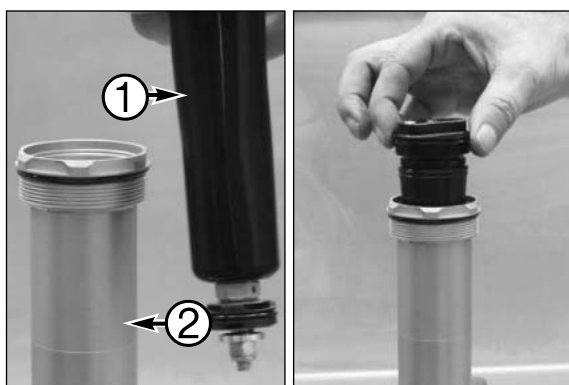

- Place slowly the membrane ❶ into the membrane holder ❷.

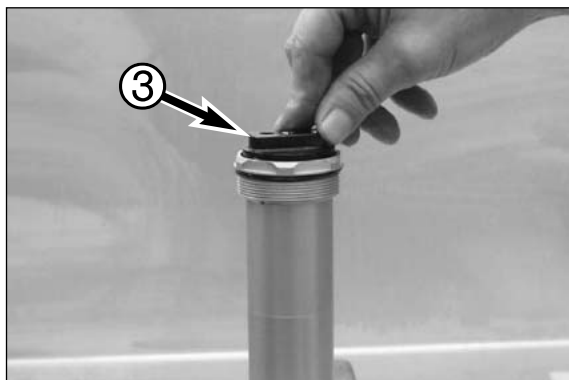

- Screw the screw-cap in the membrane holder ❸.

NOTE: Oil has to overflow from bleedhole to assure 100% bleeding.

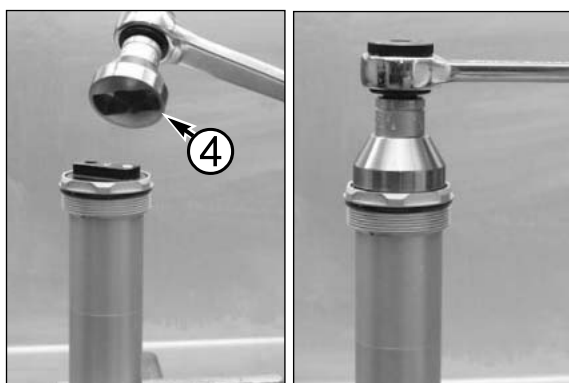

- Place T14.018 ❹ on the screw-cap.
- Tighten the screw-cap to a torque of 30 Nm.



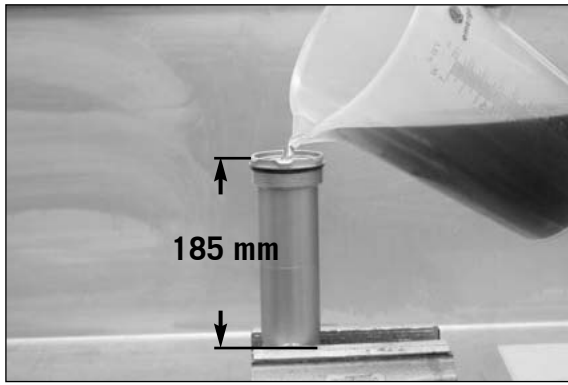

### Bleeding the closed cartridge (starting with the 2006 model)

- Clamp the membrane holder in the vise as illustrated.
- Slowly pour fork oil into the closed cartridge. The oil level should be approx. 185 mm under the upper edge of the membrane holder. The piston rod should be fully extended.



- If the membrane ① does not have the right shape (see photo), open the membrane at the groove in the screw cap and press the membrane into the right shape with a small amount of compressed air.

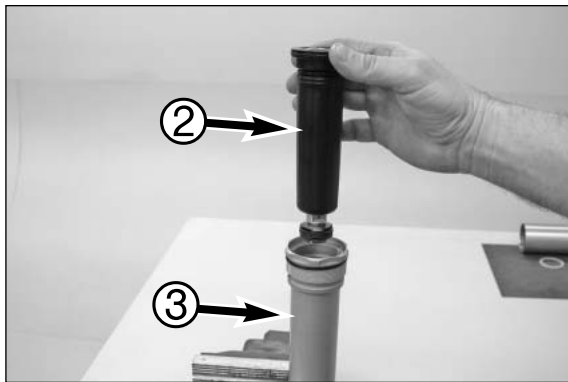

- Slowly insert the membrane ② in the membrane holder ③.

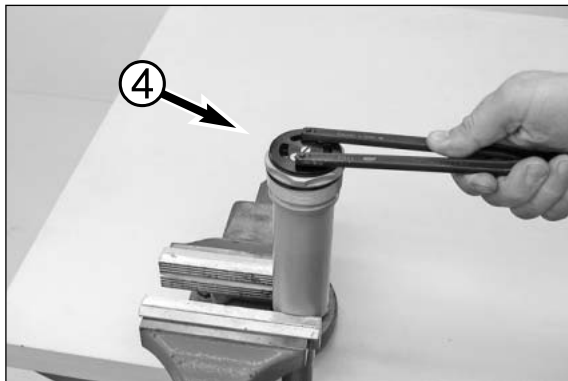

- Screw the cap ④ in the membrane holder.
- Tighten the screw cap with the T 103.

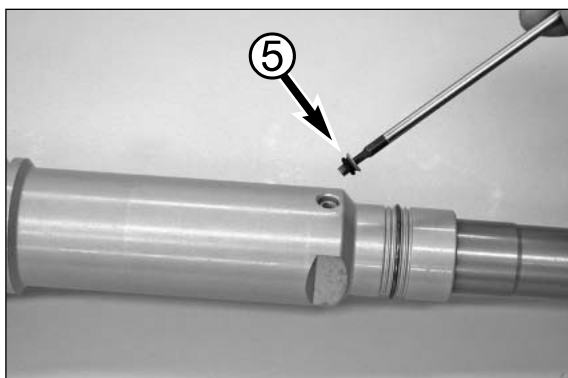

- Unclamp the cartridge and remove the AH screw ⑤ together with the O-ring.

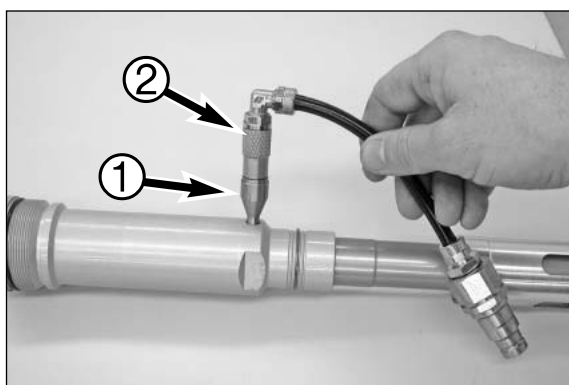

- Screw on the adapter T 14.030 ① and tighten by hand.
- Screw the filling adapter "A" ② in the adapter T 14.030.
- Connect the filling adapter "A" to the vacuum/filling device T 1240S.

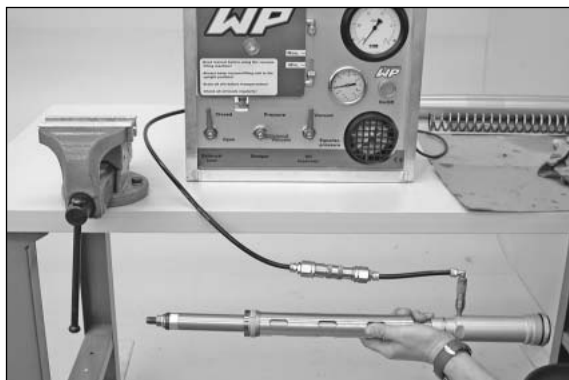

- ! CAUTION !**
- THE VACUUM/FILLING DEVICE SHOULD ONLY BE OPERATED BY PERSONS WHO HAVE READ AND UNDERSTOOD THE OPERATING INSTRUCTIONS.
  - THE CARTRIDGE MUST BE HELD LOWER THAN THE VACUUM/FILLING DEVICE WHILE FILLING FOR THE BEST POSSIBLE FILLING RESULTS.

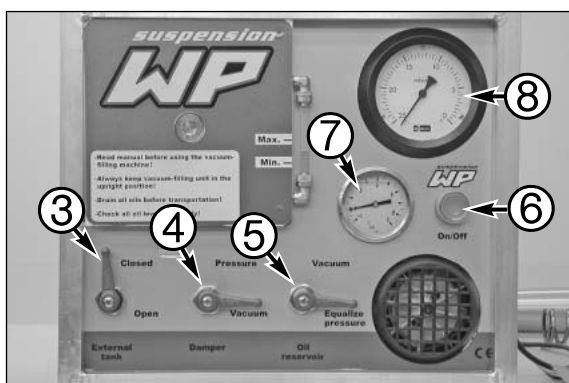

#### Ventilation/filling process

- Move the control levers into the positions shown in the photo.

NOTE: "External tank" control lever ③ to "Closed", "Damper" ④ to "Vacuum" and "Oil reservoir" ⑤ to "Equalize Pressure".

- Actuate the "On/Off" switch ⑥ and wait a few seconds until the vacuum gauge ⑧ drops to approx. 2 mbar.



- Turn the "Oil reservoir" control lever ⑤ to "Vacuum".

NOTE: the vacuum gauge ⑧ (mbar) will drop to 10 mbar and the piston rod will be retracted.



- As soon as the vacuum gauge ⑧ (mbar) reaches 10 mbar, turn the "Oil reservoir" control lever ⑤ back to "Equalize Pressure".



- Turn the "Damper" control lever ④ to "Pressure".

NOTE: oil will be pumped into the cartridge, the pressure gauge ⑦ (bar) will rise to approx. 3 bar and the piston rod will be extended again.

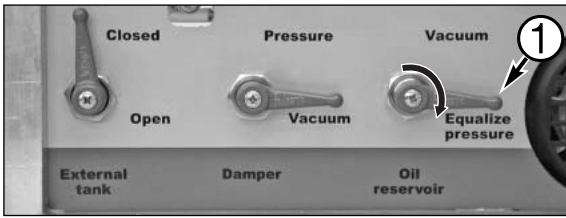

- As soon as the pressure gauge (bar) reaches approx. 3 bar, turn the "Damper" control lever **1** back to "Vacuum".

NOTE: the pressure gauge (bar) will drop to 0 bar.

- Switch off the vacuum/filling device.

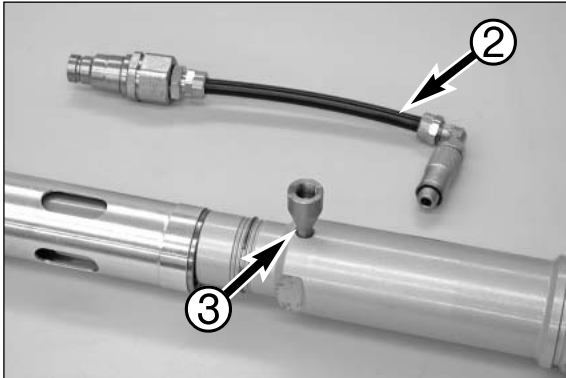

- Lay the cartridge down as shown in the photo, remove the filling adapter "A" **2** and adapter T 14.030 **3**.

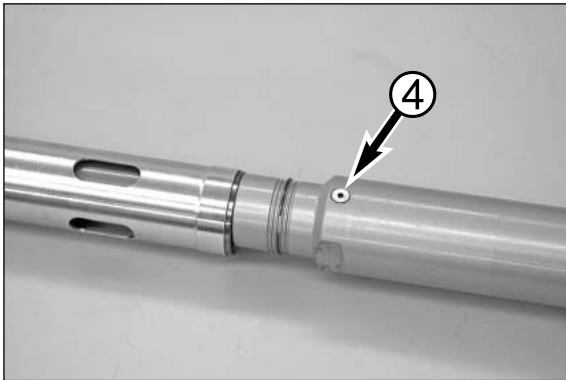

- Screw on the AH screw **4** with a new O-ring and tighten.

### On pressure with nitrogen

- Nitrogen filling gauge T14.019 ❶.

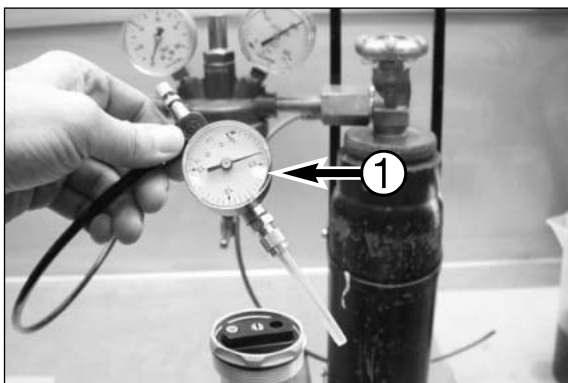

- Remove the protecting cap ❷ of the needle ❸.

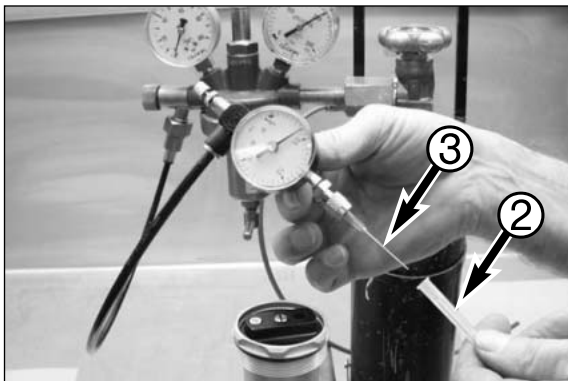

- Place the needle in the center of the filling hole ❹ of the screw-cap and push the needle completely through the rubber plug!

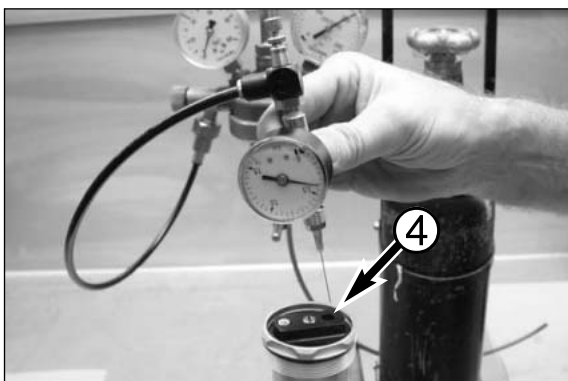

- Adjust the nitrogen pressure to 1.0 - 1.1 bar (up to model 2006) and 1.2 bar (from model 2007 on).
- Push the piston rod inside the tube! Then when the piston rod is fully extend by it self remove the charging device out the rubber plug and close the tap of the device!



- Place the seal in the screw-cap or on the Allen bolt. ❺.

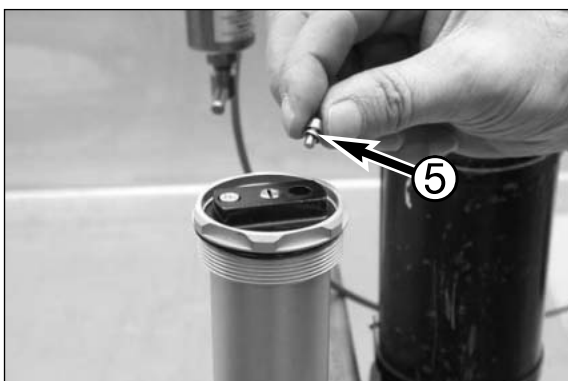

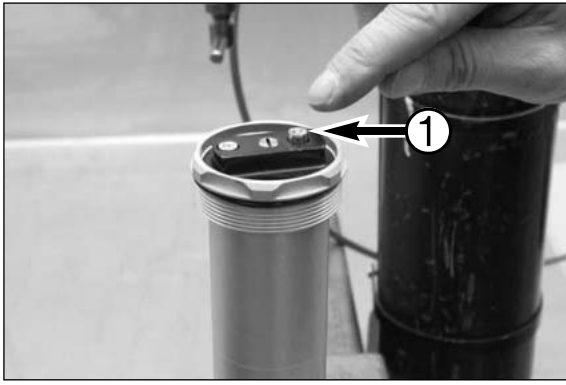

- Screw the Allen bolt ① into the screw-cap.



- Tighten the Allen bolt.

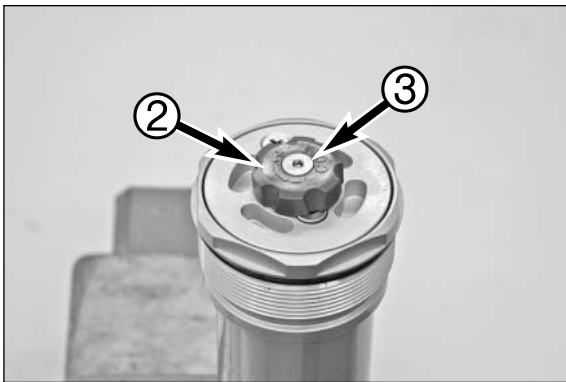

Starting with the 2007 model:

- Mount the compression adjusting screw ② and apply T131 to the thread on the screw ③. Hold the compression adjusting screw and tighten the screw.

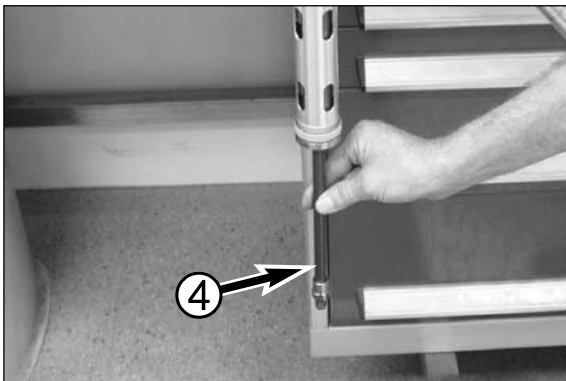

- Push through the complete stroke to release excessive oil and to assure a frictionless extension of the piston rod ④.

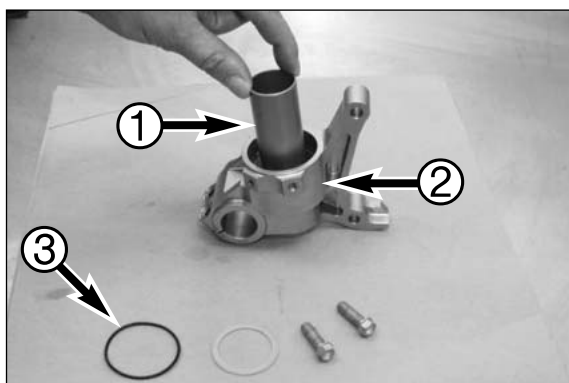

### Assembling the inner-tube / outer-tube

- Place the hydraulic sleeve ① in the axle-clamp ②.

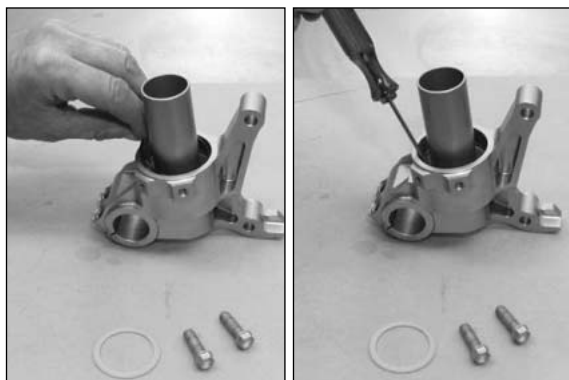

- Place a new O-ring ③ in the groove inside the axle-clamp.

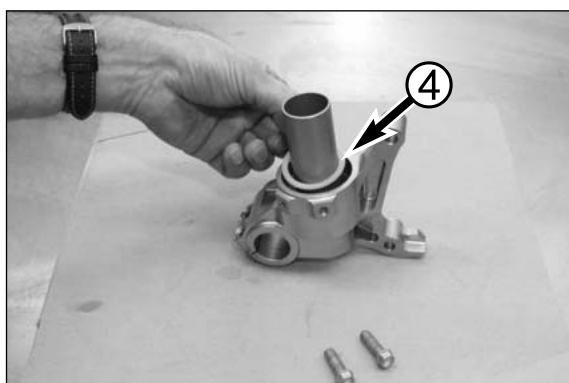

- Place the spacer ④.

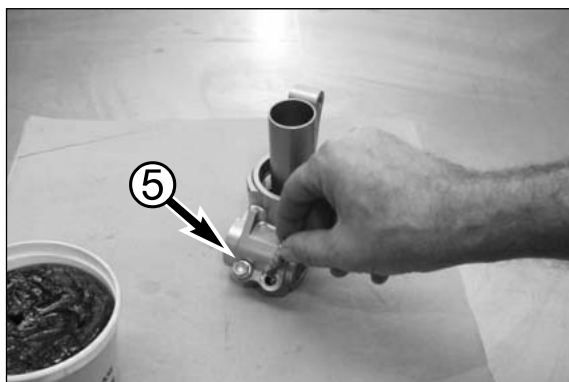

- Grease the thread of bolts ⑤ with T159.

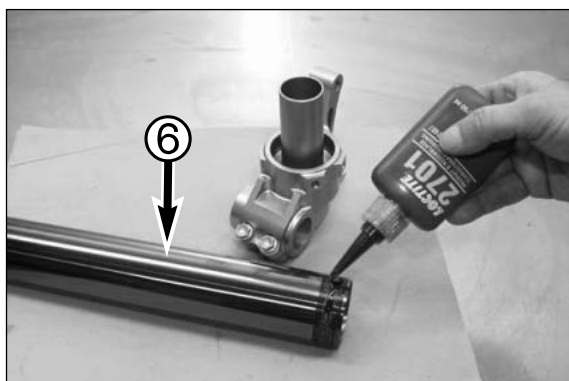

- Wet the thread of the inner-tube ⑥ with T132.

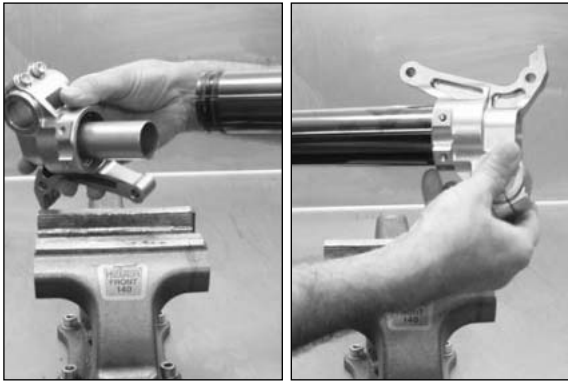

- Screw the inner-tube in the axle-clamp.

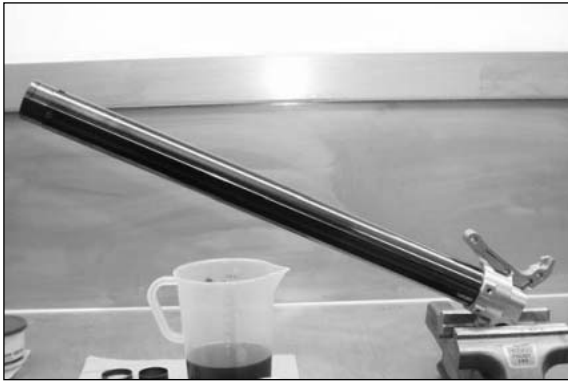

- Place the inner-tube with axle clamp in the vice according to the picture.

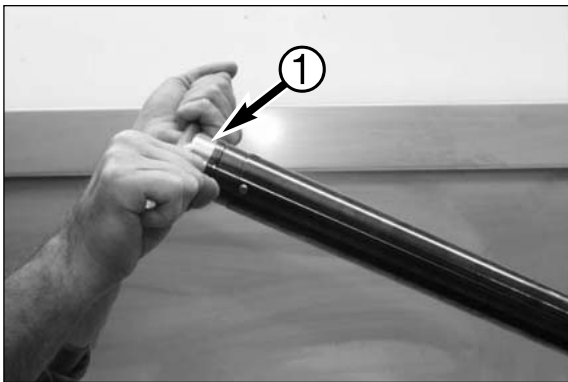

- Tighten the inner-tube with T 1404S ❶.

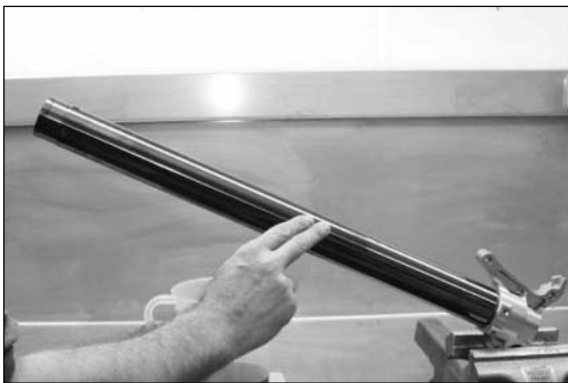

- Apply the surface of the inner-tube with front fork oil!

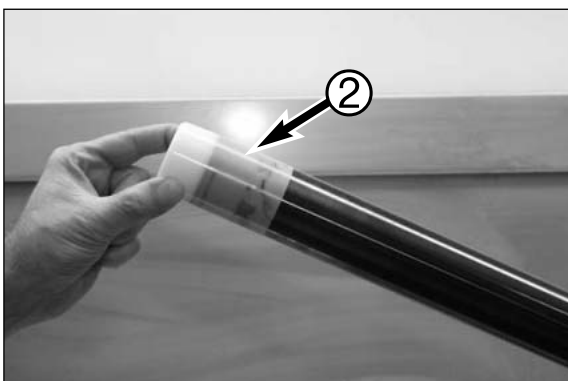

- Place T 1401 ❷ on the inner-tube.
- Apply also the special tool with front fork oil.

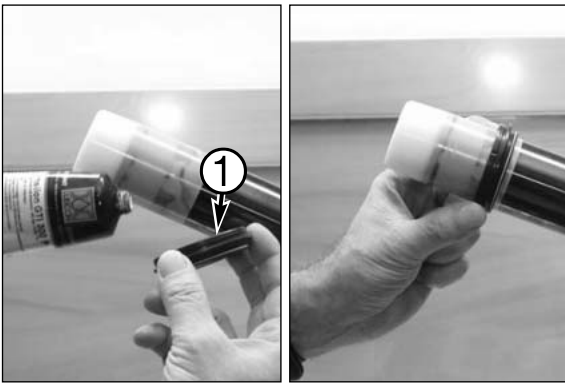

- Grease the inside of the dust stripper ❶ with T 511.
- Slide the dust stripper over the tool and inner-tube.

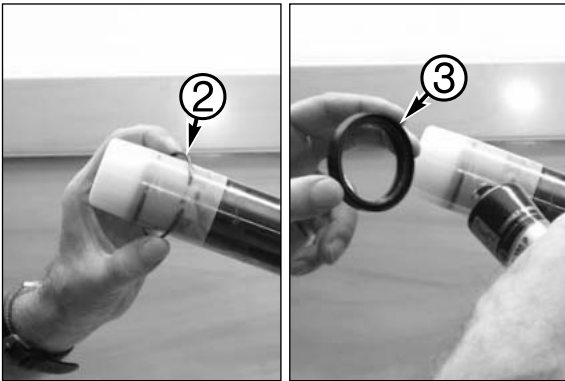

- Place the lock ring ❷.
- Grease the innerside of the oil seal ❸ with T 511.

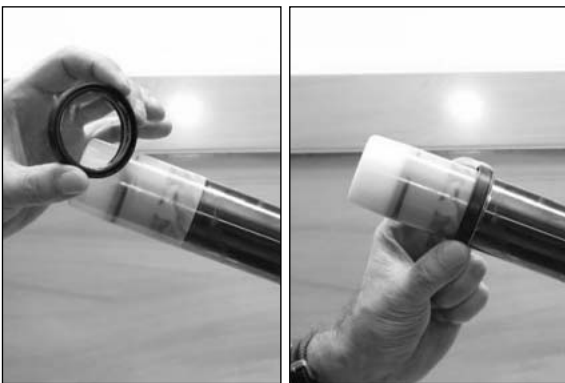

- Slide the oil seal over the tool and innertube.



- Remove T 1401.
- Place the support ring ❹.

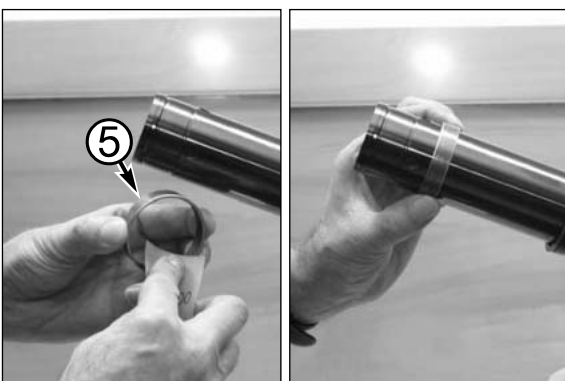

- Polish with sandpaper the edges of the DU-bush ❺ outer-tube, (Sandpaper 400 / 600).
- Clean the DU-bush after polishing!
- Place the DU-bush outer-tube.



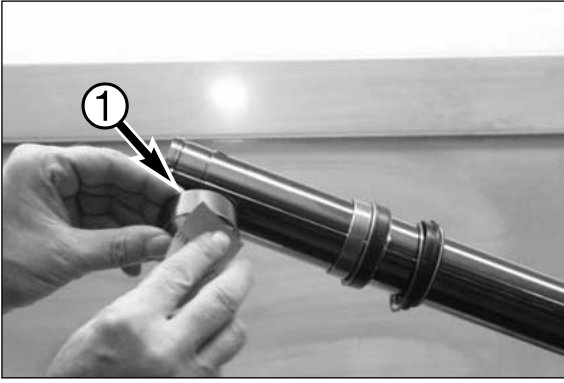

- Polish with sandpaper the edges of the DU-bush **1** inner-tube, (Sandpaper 400 / 600).
- Clean the DU-bush after polishing!



- Assemble the DU-bush inner-tube.

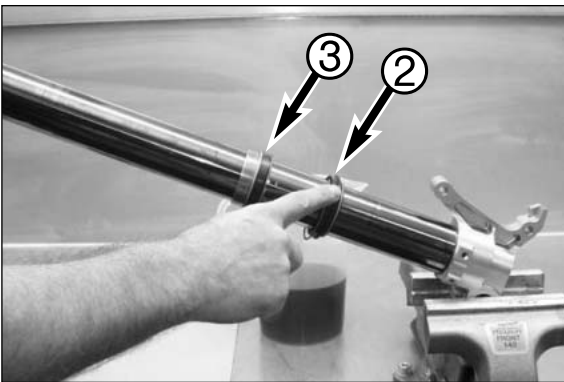

- Apply the outside of the dust stripper **2** and oil seal **3** with front fork oil.

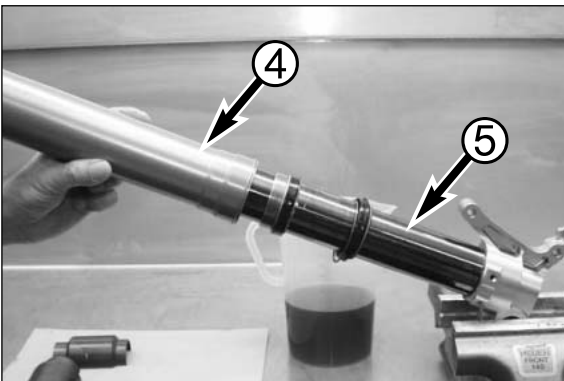

- Slide carefully the outer-tube **4** over the inner-tube **5**.



- Heat the outer-tube to a temperatur of approx. 50°C at the level of oil seal chamber of the outer-tube.

NOTE: Rotate the outer-tube while heating!

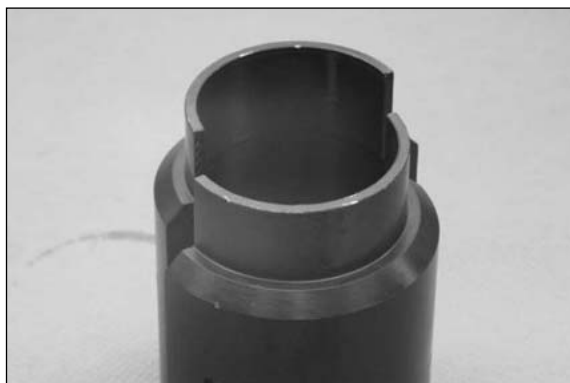

– T 1402S, assembling side for the DU-bush outer-tube.

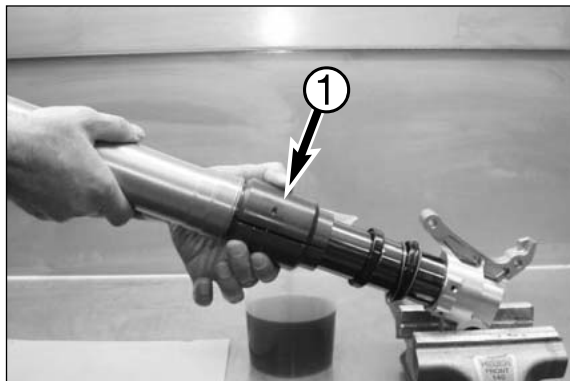

– Press the DU-bush and the support ring into the outer-tube with T 1402S ❶.



– T 1402S, assembling side for the oil seal.



– Press the oil seal into the outer-tube.

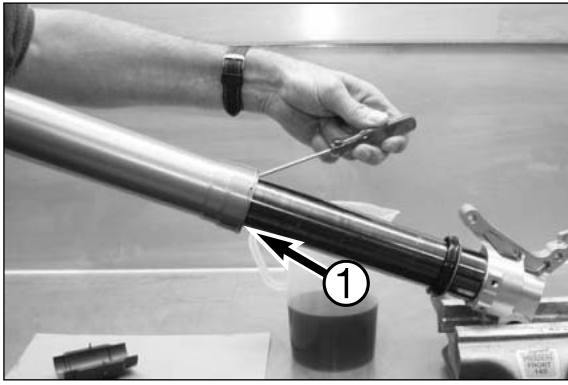

– Assemble the lock ring ❶ in the groove of the outer-tube.

NOTE: be sure that the lock washer is correctly assembled into the groove!!!

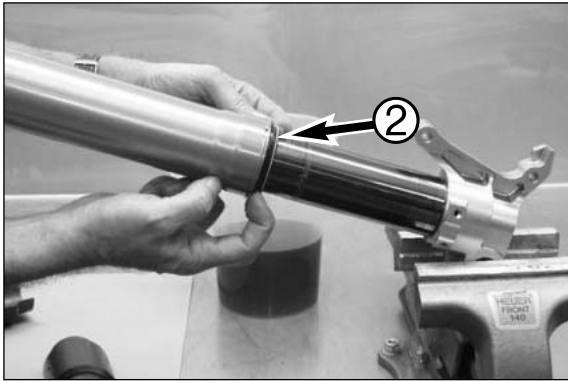

– Assemble the dust stripper ❷.



– Outer-tube / inner-tube complete!



### Assembling the cartridge in the front fork leg

- Place the front fork leg in the vice according to the picture.

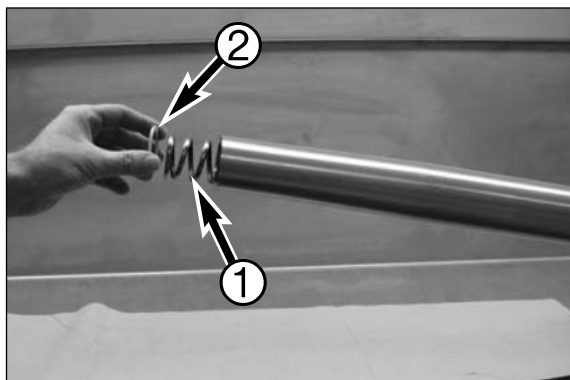

- Assemble the spring ① with spacer(s) ②.

NOTE: do not forget the bush (Modell 2006).

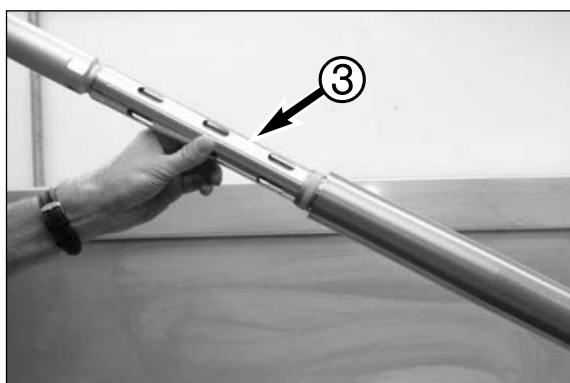

- Assemble the closed cartridge ③ into the front fork leg..

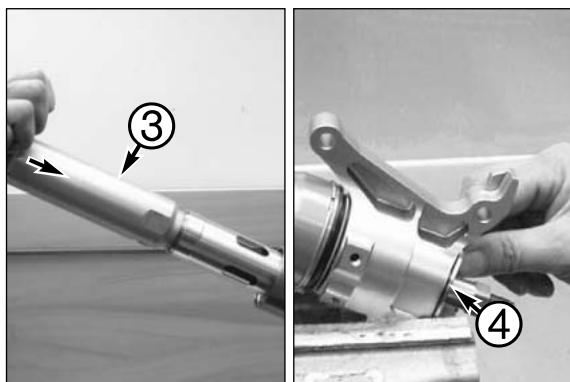

- Push the cartridge ③ against the spring preload and place T 14.020 ④ between the contra nut and axle-clamp.

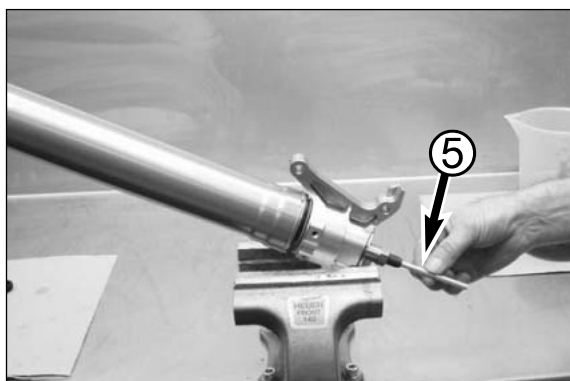

- Assemble the adjustment tube ⑤ into the piston rod.

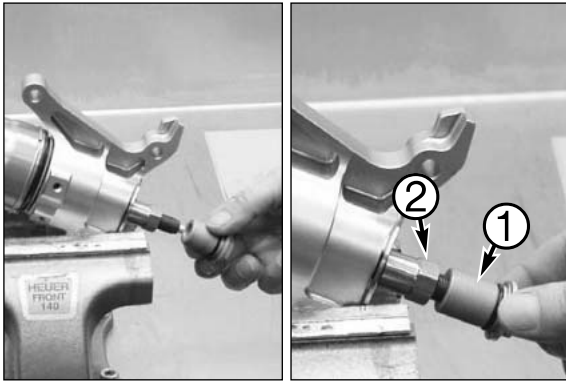

- Place the needle of the rebound adjustment adaptor into the adjustment tube and screw the rebound adjustment ① adaptor fully on the thread of the piston rod.



- Tighten the rebound adjustment adaptor against the contra nut ② to a torque of 30 Nm.

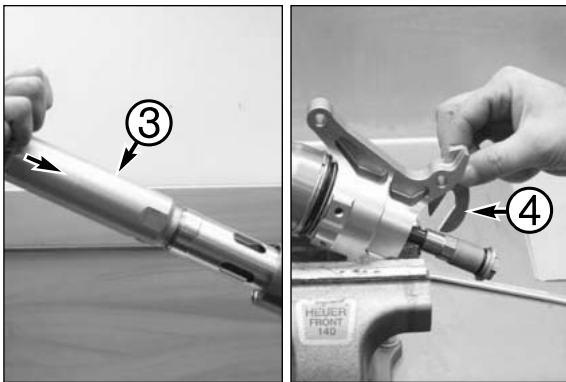

- Push the closed cartridge ③ downwards and remove T 14.020 ④.

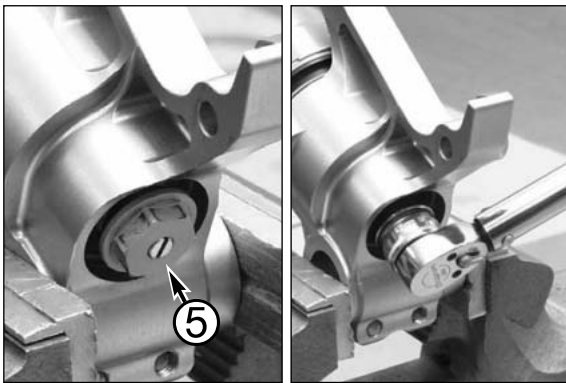

- Screw the rebound adjustment adaptor ⑤ into the axle-clamp and tighten it to a torque of 30 Nm.

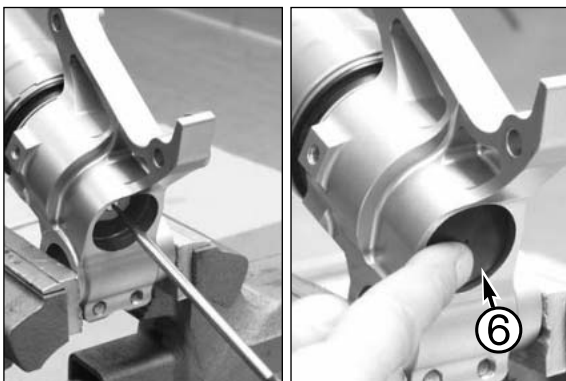

- Set the position of the rebound adjustment!
- Replace the rubber cap ⑥!

**Filling oil in the front fork leg**

- Fill the measuring jug with the correct amount of front fork oil, siehe see-list!

Max. amount of oil = 425 ml  
Min. amount of oil = 360 ml



- Fill the amount of oil into the front fork leg.

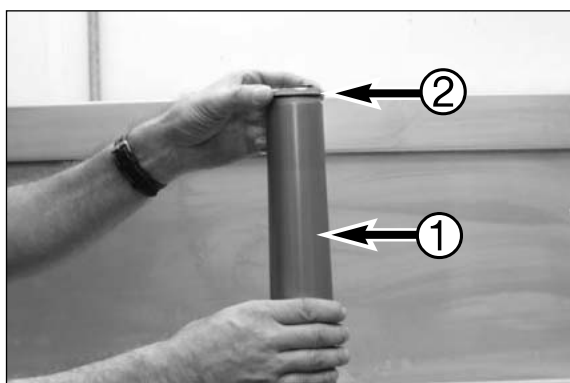

- Pull the outer-tube ① upwards and turn the membrane holder ② into the outer-tube.

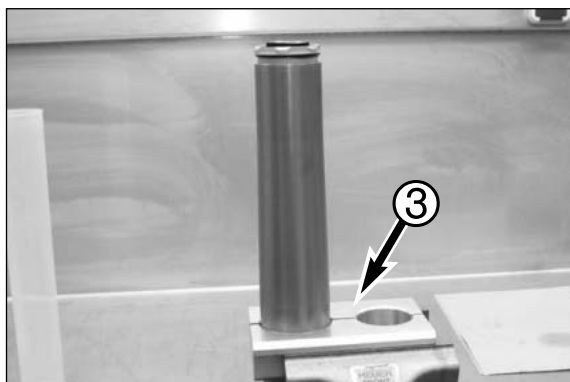

- Clamp the front fork leg in the clampingblock T 1403S ③.

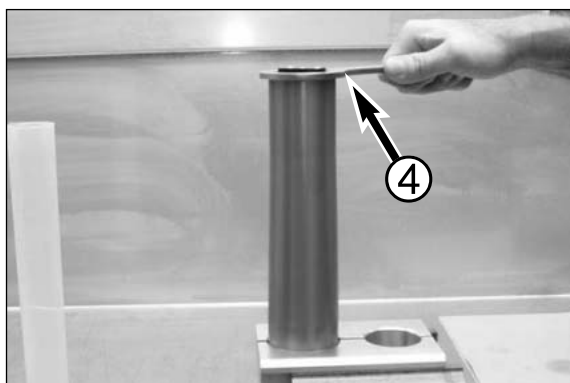

- Tighten the membrane holder with T 14.017 ④.