

⚠ Read this manual carefully before operating this vehicle.





⚠ Il convient de lire attentivement ce manuel avant la première utilisation du véhicule.

⚠ Bitte lesen Sie diese Bedienungsanleitung sorgfältig durch, bevor Sie das Fahrzeug in Betrieb nehmen.

⚠ Leggere attentamente questo manuale prima di utilizzare questo veicolo.

**OWNER'S SERVICE MANUAL
MANUEL D'ATELIER DU
PROPRIETAIRE
FAHRER- UND
WARTUNGSHANDBUCH
MANUALE DI SERVIZIO DEL
PROPRIETARIO**

YZ250
YZ250F2

-  **Read this manual carefully before operating this vehicle. This manual should stay with this vehicle if it is sold.**
-  **Il convient de lire attentivement ce manuel avant la première utilisation du véhicule. Le manuel doit être remis avec le véhicule en cas de vente de ce dernier.**
-  **Bitte lesen Sie diese Bedienungsanleitung sorgfältig durch, bevor Sie das Fahrzeug in Betrieb nehmen. Diese Bedienungsanleitung muss, wenn das Fahrzeug verkauft wird, beim Fahrzeug verbleiben.**
-  **Leggere attentamente questo manuale prima di utilizzare il veicolo. Questo manuale dovrebbe accompagnare il veicolo se viene venduto.**



YAMAHA

2015

⚠ Read this manual carefully before operating this vehicle.

OWNER'S SERVICE MANUAL

YZ250
YZ250F2

1SS-28199-33-E0

 **Read this manual carefully before operating this vehicle. This manual should stay with this vehicle if it is sold.**

YZ250

YZ250F2

OWNER'S SERVICE MANUAL

©2014 by Yamaha Motor Co., Ltd.

1st Edition, June 2014

**All rights reserved. Any reprinting or
unauthorized use without the written
permission of Yamaha Motor Co., Ltd.
is expressly prohibited.**

Printed in Japan

FOREWORD

INTRODUCTION

Congratulations on your purchase of a Yamaha YZ series. This model is the culmination of Yamaha's vast experience in the production of pacesetting racing machines. It represents the highest grade of craftsmanship and reliability that have made Yamaha a leader.

This manual explains operation, inspection, basic maintenance and tuning of your machine. If you have any questions about this manual or your machine, please contact your Yamaha dealer.

TIP

Yamaha continually seeks advancements in product design and quality. Therefore, while this manual contains the most current product information available at the time of printing, there may be minor discrepancies between your machine and this manual. If you have any questions concerning this manual, please consult your Yamaha dealer.

WARNING

PLEASE READ THIS MANUAL CAREFULLY AND COMPLETELY BEFORE OPERATING THIS MACHINE. DO NOT ATTEMPT TO OPERATE THIS MACHINE UNTIL YOU HAVE ATTAINED A SATISFACTORY KNOWLEDGE OF ITS CONTROLS AND OPERATING FEATURES AND UNTIL YOU HAVE BEEN TRAINED IN SAFE AND PROPER RIDING TECHNIQUES. REGULAR INSPECTIONS AND CAREFUL MAINTENANCE, ALONG WITH GOOD RIDING SKILLS, WILL ENSURE THAT YOU SAFELY ENJOY THE CAPABILITIES AND THE RELIABILITY OF THIS MACHINE.

IMPORTANT MANUAL INFORMATION

Particularly important information is distinguished in this manual by the following notations.



This is the safety alert symbol. It is used to alert you to potential personal injury hazards. Obey all safety messages that follow this symbol to avoid possible injury or death.

WARNING

A WARNING indicates a hazardous situation which, if not avoided, could result in death or serious injury.

NOTICE

A NOTICE indicates special precautions that must be taken to avoid damage to the vehicle or other property.

TIP

A TIP provides key information to make procedures easier or clearer.

SAFETY INFORMATION

THIS MACHINE IS DESIGNED STRICTLY FOR COMPETITION USE, ONLY ON A CLOSED COURSE. It is illegal for this machine to be operated on any public street, road, or highway. Off-road use on public lands may also be illegal. Please check local regulations before riding.

- THIS MACHINE IS TO BE OPERATED BY AN EXPERIENCED RIDER ONLY.

Do not attempt to operate this machine at maximum power until you are totally familiar with its characteristics.

- THIS MACHINE IS DESIGNED TO BE RIDDEN BY THE OPERATOR ONLY.

Do not carry passengers on this machine.

- ALWAYS WEAR PROTECTIVE APPAREL.

When operating this machine, always wear an approved helmet with goggles or a face shield. Also wear heavy boots, gloves, and protective clothing. Always wear proper fitting clothing that will not be caught in any of the moving parts or controls of the machine.

- ALWAYS MAINTAIN YOUR MACHINE IN PROPER WORKING ORDER.

For safety and reliability, the machine must be properly maintained. Always perform the pre-operation checks indicated in this manual. Correcting a mechanical problem before you ride may prevent an accident.

- GASOLINE IS HIGHLY FLAMMABLE.

Always turn off the engine while refueling. Take care to not spill any gasoline on the engine or exhaust system. Never refuel in the vicinity of an open flame, or while smoking.

- GASOLINE CAN CAUSE INJURY. If you should swallow some gasoline, inhale excess gasoline vapors, or allow any gasoline to get into your eyes, contact a doctor immediately. If any gasoline spills onto your skin or clothing, immediately wash skin areas with soap and water, and change your clothes.
- ONLY OPERATE THE MACHINE IN AN AREA WITH ADEQUATE VENTILATION.

Never start the engine or let it run for any length of time in an enclosed area. Exhaust fumes are poisonous. These fumes contain carbon monoxide, which by itself is odorless and colorless. Carbon monoxide is a dangerous gas which can cause unconsciousness or can be lethal.

- PARK THE MACHINE CAREFULLY; TURN OFF THE ENGINE.

Always turn off the engine if you are going to leave the machine. Do not park the machine on a slope or soft ground as it may fall over.

- THE ENGINE, EXHAUST PIPE, MUFFLER, AND OIL TANK WILL BE VERY HOT AFTER THE ENGINE HAS BEEN RUN.

Be careful not to touch them or to allow any clothing item to contact them during inspection or repair.

- PROPERLY SECURE THE MACHINE BEFORE TRANSPORTING IT.

When transporting the machine in another vehicle, always be sure it is properly secured and in an upright position and that the fuel cock is in the "OFF" position. Otherwise, fuel may leak out of the carburetor or fuel tank.

HOW TO USE THIS MANUAL

FINDING THE REQUIRED PAGE

1. This manual consists of seven chapters; "General Information", "Specifications", "Regular inspection and adjustments", "Engine", "Chassis", "Electrical" and "Tuning"
2. The table of contents is at the beginning of the manual. Look over the general layout of the book before finding then required chapter and item.

Bend the book at its edge, as shown, to find the required fore edge symbol mark and go to a page for required item and description.

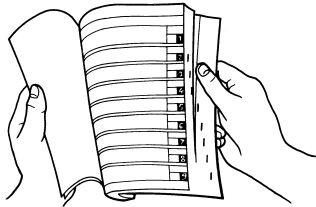

MANUAL FORMAT

All of the procedures in this manual are organized in a sequential, step-by-step format. The information has been compiled to provide the mechanic with an easy to read, handy reference that contains comprehensive explanations of all disassembly, repair, assembly, and inspection operations.

In this revised format, the condition of a faulty component will precede an arrow symbol and the course of action required will follow the symbol, e.g.,

- Bearings
Pitting/damage → Replace.

HOW TO READ DESCRIPTIONS

To help identify parts and clarify procedure steps, there are exploded diagrams at the start of each removal and disassembly section.

1. An easy-to-see exploded diagram "1" is provided for removal and disassembly jobs.

2. Numbers "2" are given in the order of the jobs in the exploded diagram. A number that is enclosed by a circle indicates a disassembly step.
3. An explanation of jobs and notes is presented in an easy-to-read way by the use of symbol marks "3". The meanings of the symbol marks are given on the next page.

4. A job instruction chart "4" accompanies the exploded diagram, providing the order of jobs, names of parts, notes in jobs, etc.
5. For jobs requiring more information, the step-by-step format supplements "5" are given in addition to the exploded diagram and job instruction chart.

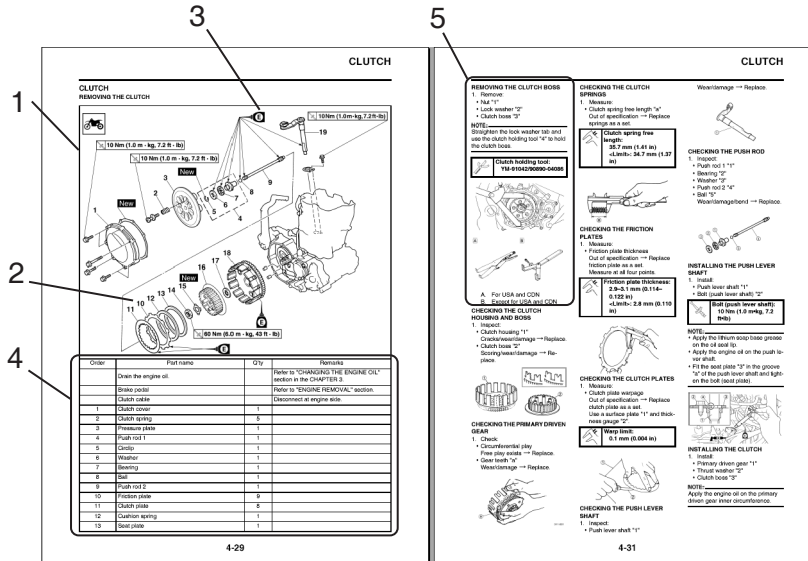

ILLUSTRATED SYMBOLS (Refer to the illustration)

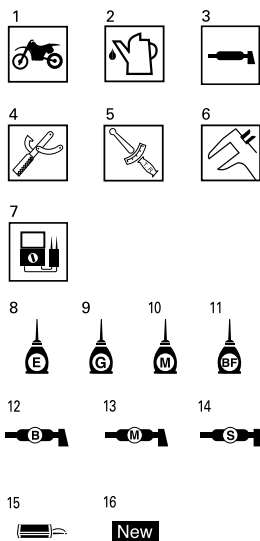

Illustrated symbols "1" to "7" are used to identify the specifications appearing in the text.

1. With engine mounted
2. Filling fluid
3. Lubricant
4. Special tool
5. Tightening
6. Specified value, Service limit
7. Resistance (Ω), Voltage (V), Electric current (A)

Illustrated symbols "8" to "14" in the exploded diagrams indicate grade of lubricant and location of lubrication point.

8. Apply engine mixing oil
9. Apply transmission oil
10. Apply molybdenum disulfide oil
11. Apply brake fluid
12. Apply lightweight lithium-soap base grease
13. Apply molybdenum disulfide grease
14. Apply silicone grease

Illustrated symbols "15" to "16" in the exploded diagrams indicate where to apply a locking agent and where to install new parts.

15. Apply locking agent (LOCTITE®)
16. Use new one

TABLE OF CONTENTS

GENERAL INFORMATION

1

SPECIFICATIONS

2

**REGULAR INSPECTION AND
ADJUSTMENTS**

3

ENGINE

4

CHASSIS

5

ELECTRICAL

6

TUNING

7

CONTENTS

CHAPTER 1 GENERAL INFORMATION

LOCATION OF IMPORTANT LABELS	1-1
DESCRIPTION	1-5
CONSUMER INFORMATION.....	1-6
INCLUDED PARTS	1-6
IMPORTANT INFORMATION.....	1-6
CHECKING OF CONNECTION.....	1-7
SPECIAL TOOLS	1-8
CONTROL FUNCTIONS.....	1-11
STARTING AND BREAK-IN	1-11
TORQUE-CHECK POINTS.....	1-13
MAINTENANCE AFTER BREAK-IN	1-14
CLEANING AND STORAGE	1-14

CHAPTER 2 SPECIFICATIONS

GENERAL SPECIFICATIONS.....	2-1
MAINTENANCE SPECIFICATIONS.....	2-3
TIGHTENING TORQUES	2-8
CABLE ROUTING DIAGRAM.....	2-14

CHAPTER 3 REGULAR INSPECTION AND ADJUSTMENTS

MAINTENANCE INTERVALS.....	3-1
PRE-OPERATION INSPECTION AND MAINTENANCE.....	3-5
ENGINE	3-6
CHASSIS	3-10
ELECTRICAL	3-20

CHAPTER 4 ENGINE

SEAT, FUEL TANK AND SIDE COVERS.....	4-1
EXHAUST PIPE AND SILENCER	4-3
RADIATOR	4-5
CARBURETOR AND REED VALVE	4-7
CYLINDER HEAD, CYLINDER AND PISTON.....	4-13
CLUTCH	4-21
KICK SHAFT AND SHIFT SHAFT	4-25
YPVS GOVERNOR.....	4-31
WATER PUMP.....	4-33
CDI MAGNETO.....	4-36
ENGINE REMOVAL	4-38
CRANKCASE AND CRANKSHAFT	4-42
TRANSMISSION, SHIFT CAM AND SHIFT FORK.....	4-47

CHAPTER 5 CHASSIS

FRONT WHEEL AND REAR WHEEL	5-1
FRONT BRAKE AND REAR BRAKE	5-6
FRONT FORK.....	5-16
HANDLEBAR.....	5-24
STEERING	5-29
SWINGARM	5-32
REAR SHOCK ABSORBER.....	5-37

CHAPTER 6 ELECTRICAL

ELECTRICAL COMPONENTS AND WIRING DIAGRAM.....	6-1
IGNITION SYSTEM.....	6-2
SOLENOID VALVE SYSTEM.....	6-5
THROTTLE POSITION SENSOR SYSTEM	6-7

CHAPTER 7 TUNING

ENGINE.....	7-1
CHASSIS	7-6

LOCATION OF IMPORTANT LABELS

GENERAL INFORMATION

LOCATION OF IMPORTANT LABELS

Please read the following important labels carefully before operating this vehicle.

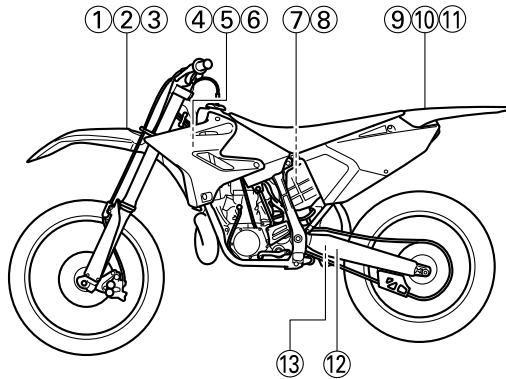

CANADA

1

Use premium unleaded gasoline/oil premix only.
3XJ-2415E-A1

2

Utiliser de préférence un mélange huile/super sans plomb.
3XJ-2415E-B1

3

THIS VEHICLE IS A COMPETITION MOTORCYCLE AND IS FOR USE EXCLUSIVELY IN CLOSED COURSE COMPETITION AND IS NOT INTENDED FOR USE ON PUBLIC HIGHWAYS.
CE VÉHICULE EST UNE MOTORCYCLETTE DE COMPÉTITION DONT L'USAGE EST RÉSERVÉ AUX COMPÉTITIONS EN CIRCUITS FERMÉS ET NON DESTINÉ AUX VOIES PUBLIQUES.
4SR-2416E-00

4

MFD. BY YAMAHA MOTOR CO., LTD. MM / YY MADE IN JAPAN
COMPETITION MOTORCYCLE
FABRIQUÉ YAMAHA MOTOR CO., LTD. MM / YY FABRIQUÉ AU JAPON
MOTORCYCLETTE DE COMPÉTITION

4SR-21186-01

5

 This spark ignition system meets all requirements of the Canadian Interference Causing Equipment Regulations.
Ce système d'allumage par étincelle de véhicule respecte toutes les exigences du Règlement sur le matériel brouilleur du Canada.
3JK-82377-10

7

▲WARNING
This unit contains high pressure nitrogen gas. Mishandling can cause explosion.
• Read owner's manual for instructions.
• Do not incinerate, puncture or open.
▲AVERTISSEMENT
Cette unité contient de l'azote à haute pression. Une mauvaise manipulation peut entraîner d'explosion.
• Voir le manuel d'utilisateur pour les instructions.
• Ne pas brûler ni perforer ni ouvrir.
4AA-22258-70



LOCATION OF IMPORTANT LABELS

9

⚠ WARNING

- BEFORE YOU OPERATE THIS VEHICLE, READ THE OWNER'S MANUAL AND ALL LABELS.
- NEVER CARRY A PASSENGER. You increase your risk of losing control if you carry a passenger.
- NEVER OPERATE THIS VEHICLE ON PUBLIC ROADS. You can collide with another vehicle if you operate this vehicle on a public road.
- ALWAYS WEAR AN APPROVED MOTORCYCLE HELMET, eye protection, and protective clothing.
- EXPERIENCED RIDER ONLY.

5PA-2118K-00

12

TIRE INFORMATION

Cold tire normal pressure should be set as follows.
 FRONT: 100kPa, {1.00kgf/cm²}, 15psi
 REAR : 100kPa, {1.00kgf/cm²}, 15psi

3RV-21668-A0

10

⚠ AVERTISSEMENT

- LIRE LE MANUEL DU PROPRIETAIRE AINSI QUE TOUTES LES ETIQUETTES AVANT D'UTILISER CE VEHICULE.
- NE JAMAIS TRANSPORTER DE PASSAGER. La conduite avec passager augmente les risques de perte de contrôle.
- NE JAMAIS ROULER SUR DES CHEMINS PUBLICS. Vous pourriez entrer en collision avec un autre véhicule.
- TOUJOURS PORTER UN CASQUE DE MOTOCYCLISTE APPROUVE, des lunettes et des vêtements de protection.
- EXCLUSIVEMENT POUR L'USAGE D'UN CONDUCTEUR EXPERIMENTE.

5PA-2118K-10

13

INFORMATION SUR LES PNEUS

La pression des pneus à froid doit normalement être réglée comme suit.
 AVANT : 100kPa, {1.00kgf/cm²}, 15psi
 ARRIERE : 100kPa, {1.00kgf/cm²}, 15psi

3RV-21668-B0

EUROPE

6





CE

YAMAHA MOTOR CO., LTD.
 SHIZUOKA JAPAN

YAMAHA 4GB-2155A-00

11

⚠

100 kPa 100 kPa
 1.00 kgf/cm² 1.00 kgf/cm²
 15 psi 15 psi

5PG-2816R-00

8



LOCATION OF IMPORTANT LABELS

AUS, NZ, ZA

8



12

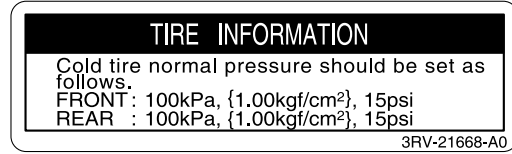







9



LOCATION OF IMPORTANT LABELS

Familiarize yourself with the following pictograms and read the explanatory text.

	<p>Read Owner's service manual.</p>
	<p>This unit contains high-pressure nitrogen gas. Mishandling can cause explosion. Do not incinerate, puncture or open.</p>
	<p>Turn off the main switch after riding to avoid draining the battery.</p>
	<p>Use unleaded gasoline only.</p>
	<p>Measure tire pressure when tires are cold.</p>
 <p>*** kPa *** kPa +.++ kgf/cm² +.++ kgf/cm² ** psi ** psi</p>	<p>Adjust tire pressure. Improper tire pressure can cause loss of control. Loss of control can result in severe injury or death.</p>

DESCRIPTION

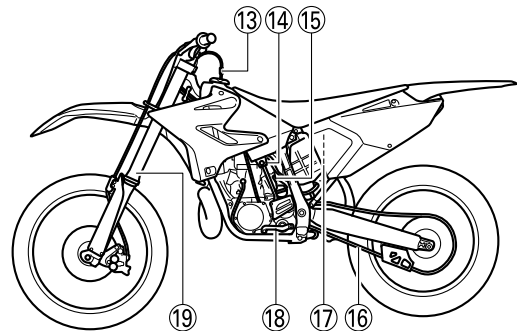
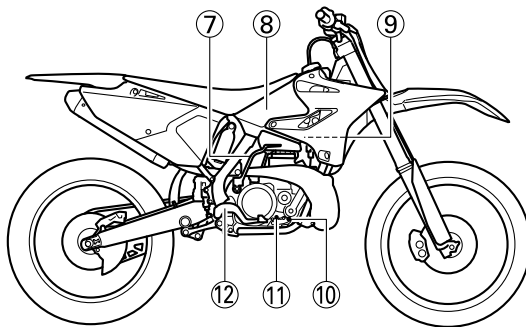
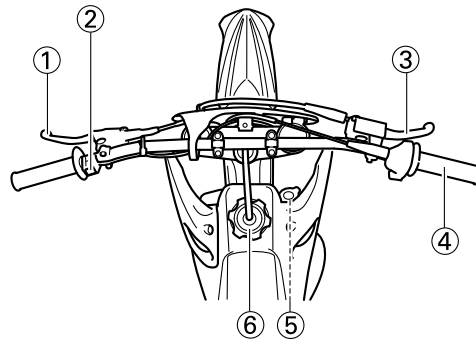

- | | |
|---|------------------|
| 1. Clutch lever | 14. Fuel cock |
| 2. Engine stop switch | 15. Starter knob |
| 3. Front brake lever | 16. Drive chain |
| 4. Throttle grip | 17. Air filter |
| 5. Radiator cap | 18. Shift pedal |
| 6. Fuel tank cap | 19. Front fork |
| 7. Kickstarter lever | |
| 8. Fuel tank | |
| 9. Radiator | |
| 10. Coolant drain bolt | |
| 11. Check bolt (Transmission oil level) | |
| 12. Rear brake pedal | |
| 13. Valve joint | |

TIP

- The machine you have purchased may differ slightly from those shown in the following.
- Designs and specifications are subject to change without notice.

CONSUMER INFORMATION

There are two significant reasons for knowing the serial number of your machine:

1. When ordering parts, you can give the number to your Yamaha dealer for positive identification of the model you own.
2. If your machine is stolen, the authorities will need the number to search for and identify your machine.

VEHICLE IDENTIFICATION NUMBER

The vehicle identification number "1" is stamped on the right of the steering head pipe.

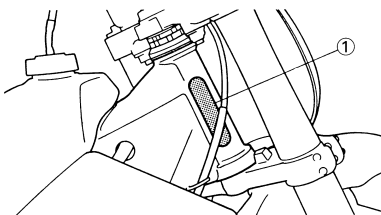

ENGINE SERIAL NUMBER

The engine serial number "1" is stamped into the elevated part of the right-side of the engine.

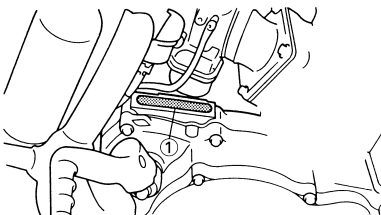

MODEL LABEL

The model label "1" is affixed to the frame under the rider's seat. This information will be needed to order spare parts.

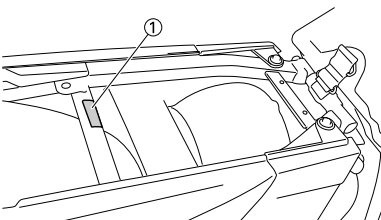

INCLUDED PARTS

DETACHABLE SIDESTAND

This sidestand "1" is used to support only the machine when standing or transporting it.

⚠ WARNING

- Never apply additional force to the sidestand.
- Remove this sidestand before starting out.

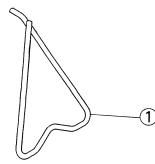

VALVE JOINT

This valve joint "1" prevents fuel from flowing out and is installed to the fuel tank breather hose.

NOTICE

In this installation, make sure the arrow faces the fuel tank and also downward.

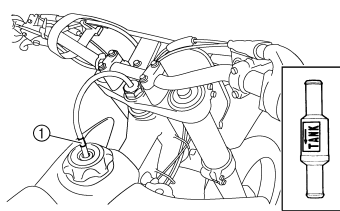

SET PIN

This set pin "1" is used to remove and install the push rod of the engine.

NOTICE

Be sure to use the set pin. If the set pin is not used, the power valve constituent parts will result in damage.

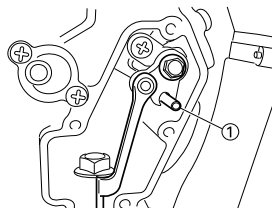

NIPPLE WRENCH

This nipple wrench "1" is used to tighten the spoke.

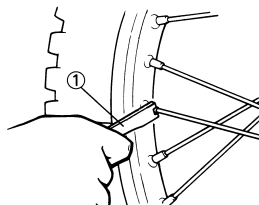

IMPORTANT INFORMATION PREPARATION FOR REMOVAL AND DISASSEMBLY

1. Remove all dirt, mud, dust, and foreign material before removal and disassembly.
 - When washing the machine with high pressured water, cover the parts follows.

- Silencer exhaust port
- Side cover air intake port
- Water pump housing hole at the bottom
- End of each hose

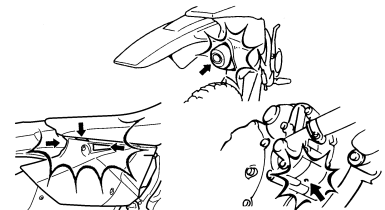
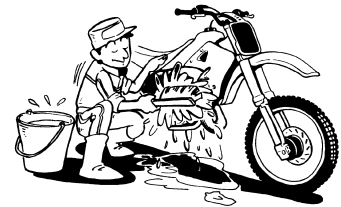

2. Use proper tools and cleaning equipment. Refer to "SPECIAL TOOLS" section.

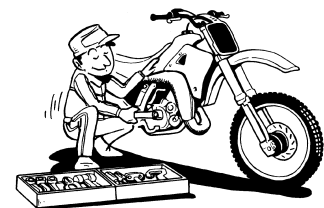

3. When disassembling the machine, keep mated parts together. They include gears, cylinders, pistons, and other mated parts that have been "mated" through normal wear. Mated parts must be reused as an assembly or replaced.



4. During the machine disassembly, clean all parts and place them in trays in the order of disassembly. This will speed up assembly time and help assure that all parts are correctly reinstalled.



5. Keep away from fire.

CHECKING OF CONNECTION

ALL REPLACEMENT PARTS

1. We recommend to use Yamaha genuine parts for all replacements. Use oil and/or grease recommended by Yamaha for assembly and adjustment.

GASKETS, OIL SEALS AND O-RINGS

1. All gaskets, oil seals, and O-rings should be replaced when an engine is overhauled. All gasket surfaces, oil seal lips, and O-rings must be cleaned.
2. Properly oil all mating parts and bearings during reassembly. Apply grease to the oil seal lips.

LOCK WASHERS/PLATES AND COTTER PINS

1. All lock washers/plates "1" and cotter pins must be replaced when they are removed. Lock tab(s) should be bent along the bolt or nut flat(s) after the bolt or nut has been properly tightened.

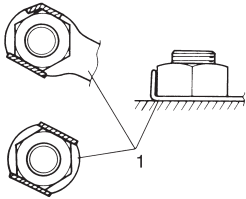

BEARINGS AND OIL SEALS

1. Install the bearing(s) "1" and oil seal(s) "2" with their manufacturer's marks or numbers facing outward. (In other words, the stamped letters must be on the side exposed to view.) When installing oil seal(s), apply a light coating of lightweight lithium base grease to the seal lip(s). Oil the bearings liberally when installing.

NOTICE

Do not use compressed air to spin the bearings dry. This causes damage to the bearing surfaces.

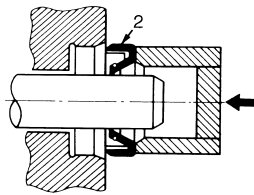
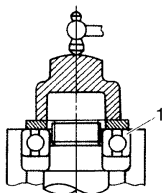

CIRCLIPS

1. All circlips should be inspected carefully before reassembly. Always replace piston pin clips after one use. Replace distorted circlips. When installing a circlip "1", make sure that the sharp-edged corner "2" is positioned opposite to the thrust "3" it receives. See the sectional view.

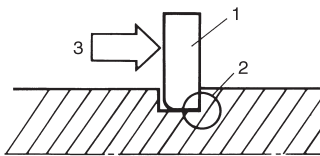

CHECKING OF CONNECTION

Dealing with stains, rust, moisture, etc. on the connector.

1. Disconnect:
 - Connector
2. Dry each terminal with an air blower.



3. Connect and disconnect the connector two or three times.
4. Pull the lead to check that it will not come off.
5. If the terminal comes off, bend up the pin "1" and reinsert the terminal into the connector.

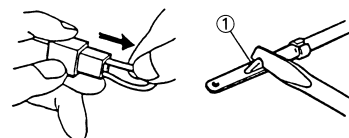

6. Connect:
 - Connector

TIP _____
The two connectors "click" together.

7. Check for continuity with a tester.

- TIP** _____
- If there is no continuity, clean the terminals.
 - Be sure to perform the steps 1 to 7 listed above when checking the wire harness.
 - For a field remedy, use a contact revitalizer available on the market.
 - Use the tester on the connector as shown.

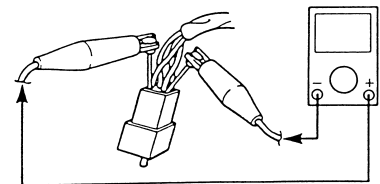
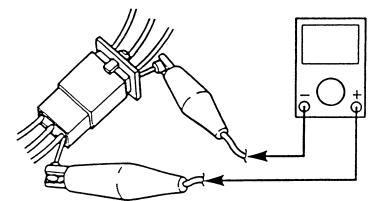

SPECIAL TOOLS

SPECIAL TOOLS



The proper special tools are necessary for complete and accurate tune-up and assembly. Using the correct special tool will help prevent damage caused by the use of improper tools or improvised techniques. The shape and part number used for the special tool differ by country, so two types are provided. Refer to the list provided to avoid errors when placing an order.

TIP

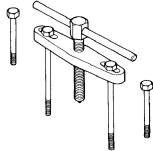
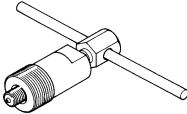
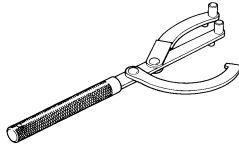
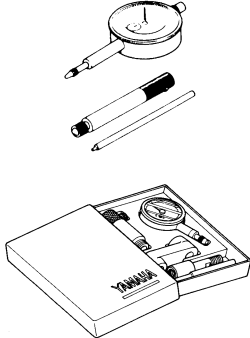
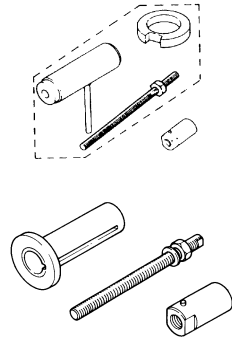
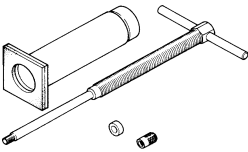
- For U.S.A. and Canada, use part number starting with "YM-", "YU-" or "ACC-".
- For others, use part number starting with "90890-".

Tool name/Part number	How to use	Illustration
Crankcase separating tool YU-01135-B, 90890-01135	These tool is used to remove the crankshaft from either case.	
Flywheel puller YM-01189, 90890-01189	This tool is used to remove the flywheel magneto.	
Rotor holding tool YU-01235, 90890-01235	This tool is used when loosening or tightening the flywheel magneto securing nut.	
Dial gauge and stand YU-03097-B, 90890-01252 Stand YU-01256	These tools are used to check each part for runout or bent.	
Crankshaft installing tool Crankshaft installing pot YU-90058, 90890-01274 Crankshaft installing bolt YU-90060, 90890-01275 Adapter YU-90063, 90890-01278	These tools are used to install the crankshaft.	
Piston pin puller set YU-01304, 90890-01304	This tool is used to remove the piston pin.	

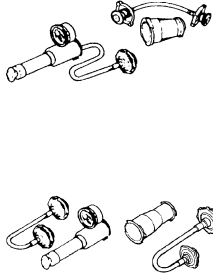
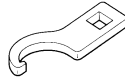
SPECIAL TOOLS

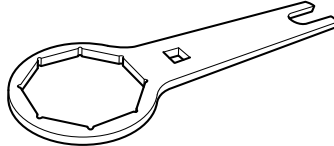
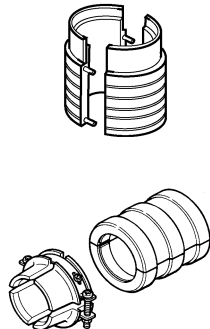
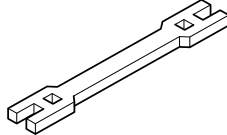
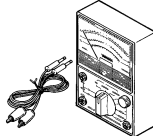
Tool name/Part number	How to use	Illustration
Radiator cap tester YU-24460-A, 90890-01325 Radiator cap tester adapter YU-33984, 90890-01352	These tools are used for checking the cooling system.	
Steering nut wrench YU-A9472, 90890-01403	This tool is used when tighten the steering ring nut to specification.	
Cap bolt wrench YM-01500, 90890-01500	This tool is used to loosen or tighten the base valve.	
Cap bolt ring wrench YM-01501, 90890-01501	This tool is used to loosen or tighten the damper assembly.	
Fork seal driver YM-A0948, 90890-01502	This tool is used when install the fork oil seal.	
Spoke nipple wrench YM-01521, 90890-01521	This tool is used to tighten the spoke.	
Pocket tester YU-03112-C, 90890-03112	Use this tool to inspect the coil resistance, output voltage and amperage.	

SPECIAL TOOLS

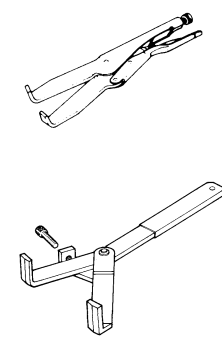
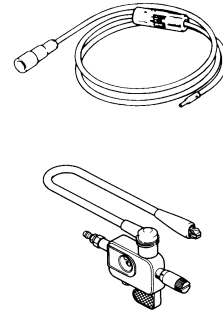
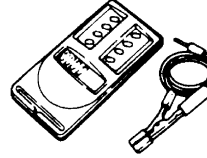
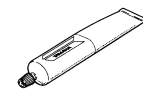
Tool name/Part number	How to use	Illustration
Clutch holding tool YM-91042, 90890-04086	This tool is used to hold the clutch when removing or installing the clutch boss securing nut.	
Dynamic spark tester YM-34487 Ignition checker 90890-06754	This instrument is necessary for checking the ignition system components.	
Digital tachometer YU-39951-B, 90890-06760	This tool is needed for observing engine rpm.	
Yamaha bond No. 1215 90890-85505 (Three bond No. 1215®)	This sealant (Bond) is used for crankcase mating surface, etc.	

CONTROL FUNCTIONS

ENGINE STOP SWITCH

The engine stop switch "1" is located on the left handlebar. Continue pushing the engine stop switch till the engine comes to a stop.

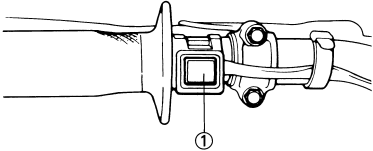

CLUTCH LEVER

The clutch lever "1" is located on the left handlebar; it disengages or engages the clutch. Pull the clutch lever to the handlebar to disengage the clutch, and release the lever to engage the clutch. The lever should be pulled rapidly and released slowly for smooth starts.

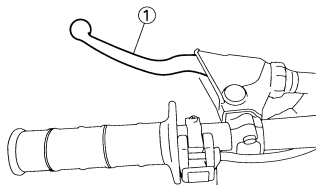

SHIFT PEDAL

The gear ratios of the constant-mesh 5 speed transmission are ideally spaced. The gears can be shifted by using the shift pedal "1" on the left side of the engine.

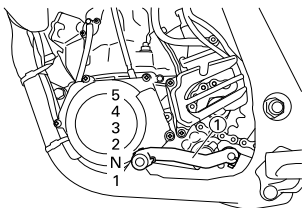

KICKSTARTER LEVER

Rotate the kickstarter lever "1" away from the engine. Push the starter down lightly with your foot until the gears engage, then kick smoothly and forcefully to start the engine. This model has a primary kickstarter lever so the engine can be started in any gear if the clutch is disengaged. In normal practices, however, shift to neutral before starting.

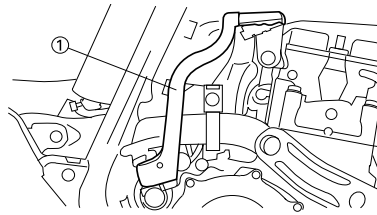

THROTTLE GRIP

The throttle grip "1" is located on the right handlebar; it accelerates or decelerates the engine. For acceleration, turn the grip toward you; for deceleration, turn it away from you.

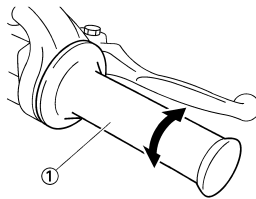

FRONT BRAKE LEVER

The front brake lever "1" is located on the right handlebar. Pull it toward the handlebar to activate the front brake.

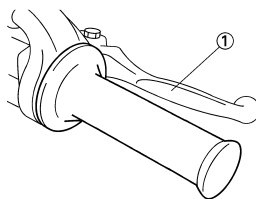

REAR BRAKE PEDAL

The rear brake pedal "1" is located on the right side of the machine. Press down on the brake pedal to activate the rear brake.



FUEL COCK

The fuel cock supplies fuel from the tank to carburetor and also filters the fuel. The fuel cock has the two positions:

OFF:

With the lever in this position, fuel will not flow. Always return the lever to this position when the engine is not running.

ON:

With the lever in this position, fuel flows to the carburetor. Normal riding is done with the lever in this position.

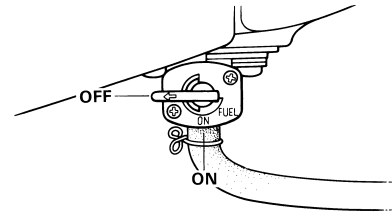

STARTER KNOB (CHOKE)

When cold, the engine requires a richer air-fuel mixture for starting. A separate starter circuit, which is controlled by the starter knob "1", supplies this mixture. Pull the starter knob out to open the circuit for starting. When the engine has warmed up, push it in to close the circuit.

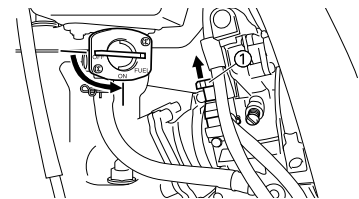

STARTING AND BREAK-IN

FUEL

Mix oil with the gas at the ratio specified below. Always use fresh, name-brand gasoline, and mix the oil and gas the day of the race. Do not use premix that is more than a few hours old.

	Recommended fuel:
	Premium unleaded gasoline only with a research octane number of 95 or higher.

TIP

If knocking or pinging occurs, use a different brand of gasoline or higher octane grade.

NOTICE

Never mix two types of oil in the same batch; clotting of the oil could result. If you wish to change oil types, be sure to drain the fuel tank and the carburetor float bowl of old premix prior to filling with the new type.

	Fuel tank capacity:
	8.0 L (1.8 Imp gal, 2.1 US gal)

STARTING AND BREAK-IN

	Mixing oil: Recommended oil: YAMALUBE "2-R" (YAMALUBE racing 2-cycle oil) Mixing ratio: 30:1 If unavailable, use an equivalent type of oil.
---	--

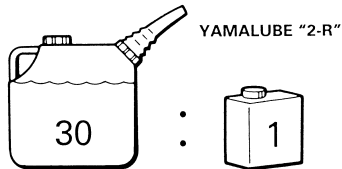

HANDLING NOTE

NOTICE

Before starting the machine, perform the checks in the pre-operation check list.

WARNING

Never start or run the engine in a closed area. The exhaust fumes are poisonous; they can cause loss of consciousness and death in a very short time. Always operate the machine in a well-ventilated area.

AIR FILTER MAINTENANCE

According to "CLEANING THE AIR FILTER ELEMENT" section in the CHAPTER 3, apply the foam-air-filter oil or its equivalent to the element. (Excess oil in the element may adversely affect engine starting.)

STARTING A COLD ENGINE

1. Shift the transmission into neutral.
2. Turn the fuel cock to "ON" and full open the starter knob (CHOKE).
3. With the throttle completely closed start the engine by kicking the kick starter forcefully with firm stroke.
4. Run the engine at idle or slightly higher until it warms up: this usually takes about one or two minutes.
5. The engine is warmed up when it responds normally to the throttle with the starter knob (CHOKE) turned off.

NOTICE

Do not warm up the engine for extended periods of time.

STARTING A WARM ENGINE

Do not operate the starter knob (CHOKE). Open the throttle slightly and start the engine by kicking the kick starter forcefully with firm stroke.

NOTICE

Observe the following break-in procedures during initial operation to ensure optimum performance and avoid engine damage.

BREAK-IN PROCEDURES

1. Before starting the engine, fill the fuel tank with a break-in oil-fuel mixture as follows.

	Mixing oil: YAMALUBE "2-R" Mixing ratio: 15:1
---	--
2. Perform the pre-operation checks on the machine.
3. Start and warm up the engine. Check the idle speed, and check the operation of the controls and the "ENGINE STOP" button.
4. Operate the machine in the lower gears at moderate throttle openings for five to eight minutes. Stop and check the spark plug condition; it will show a rich condition during break-in.
5. Allow the engine to cool. Restart the engine and operate the machine as in the step above for five minutes. Then, very briefly shift to the higher gears and check full-throttle response. Stop and check the spark plug.
6. After again allowing the engine to cool, restart and run the machine for five more minutes. Full throttle and the higher gears may be used, but sustained full-throttle operation should be avoided. Check the spark plug condition.
7. Allow the engine to cool, remove the top end, and inspect the piston and cylinder. Remove any high spots on the piston with #600 grit wet sandpaper. Clean all components and carefully reassemble the top end.
8. Drain the break-in oil-fuel mixture from the fuel tank and refill with the specified mix.

9. Restart the engine and check the operation of the machine throughout its entire operating range. Stop and check the spark plug condition. Restart the machine and operate it for about 10 to 15 more minutes. The machine will now be ready to race.

NOTICE

- After the break-in or before each race, you must check the entire machine for loose fittings and fasteners as per "TORQUE-CHECK POINTS". Tighten all such fasteners as required.
- When any of the following parts have been replaced, they must be broken in.
CYLINDER AND CRANKSHAFT: About one hour of break-in operation is necessary.
PISTON, RING AND GEARS: These parts require about 30 minutes of break-in operation at half-throttle or less. Observe the condition of the engine carefully during operation.

TORQUE-CHECK POINTS

TORQUE-CHECK POINTS

Frame construction			Frame to rear frame		
		Combined seat and fuel tank	Fuel tank to frame		
Exhaust system			Silencer to rear frame		
Engine mounting			Frame to engine		
			Engine bracket to engine		
			Engine bracket to frame		
Steering		Steering stem to handlebar			
			Steering stem to frame		
			Steering stem to upper bracket		
		Upper bracket to handlebar			
Suspension	Front	Steering stem to front fork			
			Front fork to upper bracket		
			Front fork to lower bracket		
	Rear	For link type		Assembly of links	
				Link to frame	
				Link to rear shock absorber	
				Link to swingarm	
		Installation of rear shock absorber	Rear shock absorber to frame		
	Installation of swingarm	Tightening of pivot shaft			
Wheel		Installation of wheel			
				Front	Tightening of wheel axle
				Rear	Tightening of wheel axle
	Wheel to rear wheel sprocket				
Brake		Front		Brake caliper to front fork	
				Brake disc to wheel	
				Tightening of union bolt	
				Brake master cylinder to handlebar	
				Tightening of bleed screw	
				Tightening of brake hose holder	
		Rear		Brake pedal to frame	
				Brake disc to wheel	
				Tightening of union bolt	
				Brake master cylinder to frame	
				Tightening of bleed screw	
	Tightening of brake hose holder				
Fuel system			Fuel tank to fuel cock		

TIP

Concerning the tightening torque, refer to "TIGHTENING TORQUES" section in the CHAPTER 2.

MAINTENANCE AFTER BREAK-IN

MAINTENANCE AFTER BREAK-IN

After a break-in, perform careful maintenance to get ready for the next practice or race.

Refer to "PRE-OPERATION INSPECTION AND MAINTENANCE" section in the CHAPTER 3.

MAJOR MAINTENANCE

1. For the engine
 - Leaks around the engine
Check for pressure leaks from the cylinder head or the cylinder, oil leaks from the crankcase or the case cover, leaks from the coolant system, and other leaks.
 - Check that the cylinder, the piston, and the piston ring fit one another, and that contact between the cylinder and the piston are correct.
 - Transmission oil change
Drain the oil, and check for dirt and foreign materials such as metal chips. (If any foreign material is mixed, disassemble and check the transmission.)
Pour the specified amount of the recommended oil.
 - Carburetor
Disassemble the carburetor and clean the small holes, blowing them with compressed air.
 - CDI magneto
Check for looseness in mounted areas of the rotor and the stator. Check that the connector is not being disconnected.
 - Silencer
Check the main body and stay for cracks.
Check for leaks.
 - Mounting bolts and nuts
Check for looseness in mounted areas of parts, as well as engine mounting bolts and engine brackets.
2. For the chassis
 - Check welds and mounted areas of the frame, the swingarm, the link, the bracket, and so on, for looseness and cracks.
 - Wheel (s)
Check the wheel for runout.
Check the spoke for looseness.
 - Brake(s)
Check the brake disc mounting bolt for looseness.
Check that the reservoir contains the specified amount of brake fluid. Check for leaks.

- Cable
Grease and adjust cables.
- Drive chain
Lubricate the drive chain and adjust its tension.
- Fuel tank
Clean the inside of the fuel tank and the fuel cock. Check for leaks.
- Suspension
Check for oil leaks in the front fork or the rear shock absorber. Check that the mounted conditions are good.
- Sprocket
Check for looseness in the sprocket mounted on the rear wheel.
- Mounting bolts and nuts
Check mounted areas for looseness.

NOTICE

After a break-in or before each race, always check the points shown in "TORQUE-CHECK POINTS" for tightening torques and retighten them. (Refer to "TORQUE-CHECK POINTS".)

- Greasing and oiling
Always grease or oil the specified points.

CLEANING AND STORAGE

CLEANING

Frequent cleaning of your machine will enhance its appearance, maintain good overall performance, and extend the life of many components.

1. Before washing the machine, block off the end of the exhaust pipe to prevent water from entering. A plastic bag secured with a rubber band may be used for this purpose.
2. If the engine is excessively greasy, apply some degreaser to it with a paint brush. Do not apply degreaser to the chain, sprockets, or wheel axles.
3. Rinse the dirt and degreaser off with a garden hose; use only enough pressure to do the job.

NOTICE

Do not use high-pressure washers or steam-jet cleaners since they cause water seepage and deterioration seals.

4. After the majority of the dirt has been hosed off, wash all surfaces with warm water and a mild detergent. Use an old toothbrush to clean hard-to-reach places.

5. Rinse the machine off immediately with clean water, and dry all surfaces with a soft towel or cloth.
6. Immediately after washing, remove excess water from the chain with a paper towel and lubricate the chain to prevent rust.
7. Clean the seat with a vinyl upholstery cleaner to keep the cover pliable and glossy.
8. Automotive wax may be applied to all painted or chromed surfaces. Avoid combination cleaner-waxes, as they may contain abrasives.
9. After completing the above, start the engine and allow it to idle for several minutes.

STORAGE

If your machine is to be stored for 60 days or more, some preventive measures must be taken to avoid deterioration. After cleaning the machine thoroughly, prepare it for storage as follows:

1. Drain the fuel tank, fuel lines, and the carburetor float bowl.
2. Remove the spark plug, pour a tablespoon of SAE 10W-40 motor oil in the spark plug hole, and re-install the plug. With the engine stop switch pushed in, kick the engine over several times to coat the cylinder walls with oil.
3. Remove the drive chain, clean it thoroughly with solvent, and lubricate it. Reinstall the chain or store it in a plastic bag tied to the frame.
4. Lubricate all control cables.
5. Block the frame up to raise the wheels off the ground.
6. Tie a plastic bag over the exhaust pipe outlet to prevent moisture from entering.
7. If the machine is to be stored in a humid or salt-air environment, coat all exposed metal surfaces with a film of light oil. Do not apply oil to rubber parts or the seat cover.

TIP

Make any necessary repairs before the machine is stored.

GENERAL SPECIFICATIONS

2

SPECIFICATIONS

GENERAL SPECIFICATIONS

Model name:	YZ250F2 (USA, CDN, AUS, NZ) YZ250 (EUROPE, ZA)
Model code number:	1SSD (USA, CDN) 1SSE (EUROPE) 1SSG (AUS, NZ, ZA)
Dimensions:	
Overall length	2,147 mm (84.4 in)
Overall width	827 mm (32.6 in)
Overall height	1,299 mm (51.2 in)
Seat height	976 mm (38.4 in)
Wheelbase	1,446 mm (56.9 in)
Minimum ground clearance	367 mm (14.4 in)
Weight:	
Curb weight	103 kg (227 lb)
Engine:	
Engine type	Liquid cooled 2-stroke, gasoline
Cylinder arrangement	Single cylinder
Displacement	249 cm ³ (8.76 Imp oz, 8.42 US oz)
Bore × stroke	66.4 × 72 mm (2.6 × 2.8 in)
Compression ratio	8.9–10.6:1
Starting system	Kick starter
Lubrication system:	Premix (30:1)(YAMALUBE 2-R)
Oil type or grade (2-stroke):	
Transmission oil	Recommended brand: YAMALUBE SAE10W-40 API service SG type or higher JASO standard MA
Periodic oil change	0.75 L (0.66 Imp qt, 0.79 US qt)
Total amount	0.80 L (0.70 Imp qt, 0.85 US qt)
Coolant capacity (including all routes):	1.20 L (1.06 Imp qt, 1.27 US qt)
Air filter:	Wet type element
Fuel:	
Type	Premium unleaded gasoline only with a research octane number of 95 or higher.
Tank capacity	8.0 L (1.8 Imp gal, 2.1 US gal)
Carburetor:	
Type/Manufacturer	PWK38S/KEIHIN
Spark plug:	
Type/Manufacturer	BR8EG/NGK (resistance type)
Gap	0.5–0.6 mm (0.020–0.024 in)
Clutch type:	Wet, multiple-disc

GENERAL SPECIFICATIONS

Transmission: Primary reduction system Primary reduction ratio Final drive Secondary reduction ratio Transmission type Operation Gear ratio: 1st 2nd 3rd 4th 5th	Gear 3.000 (63/21) Chain 3.571 (50/14) Constant mesh, 5-speed Left foot operation 1.929 (27/14) 1.533 (23/15) 1.278 (23/18) 1.091 (24/22) 0.952 (20/21)
Chassis: Frame type Caster angle Trail	Semi double cradle 26.00 ° 109 mm (4.3 in)
Tire: Type Size (front) Size (rear) Tire pressure (front and rear)	With tube 80/100-21 51M 110/90-19 62M 100 kPa (1.00 kgf/cm ² , 15 psi)
Brake: Front brake type Operation Rear brake type Operation	Single disc brake Right hand operation Single disc brake Right foot operation
Suspension: Front suspension Rear suspension	Telescopic fork Swingarm (link type monocross suspension)
Shock absorber: Front shock absorber Rear shock absorber	Coil spring/oil damper Coil spring/gas, oil damper
Wheel travel: Front wheel travel Rear wheel travel	300 mm (11.8 in) 315 mm (12.4 in)
Electrical: Ignition system	CDI magneto

MAINTENANCE SPECIFICATIONS

MAINTENANCE SPECIFICATIONS ENGINE

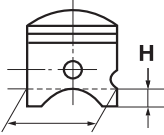
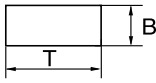
Item	Standard	Limit
Cylinder head: Combustion chamber volume Warp limit	21.35–21.65 cm ³ (1.30–1.32 cu.in) ----	---- 0.03 mm (0.0012 in)
Cylinder: Bore size Taper limit Out of round limit	66.400–66.414 mm (2.6142–2.6147 in) ---- ----	66.500 mm (2.6181 in) 0.050 mm (0.0020 in) 0.010 mm (0.0004 in)
Piston: Piston size/ Measuring point "H"  Piston clearance Piston offset	66.352–66.367 mm (2.6123–2.6129 in) 17.5 mm (0.69 in) 0.045–0.050 mm (0.0018–0.0020 in) 1.50 mm (0.0591 in)/EX-side	---- ---- 0.100 mm (0.0039 in) ----
Piston pin: Piston pin outside diameter	17.995–18.000 mm (0.7085–0.7087 in)	17.975 mm (0.7077 in)
Piston ring: Sectional sketch  End gap (installed) Side clearance (installed):1st Side clearance (installed):2nd	Plain B=1.00 mm (0.04 in) T=2.55 mm (0.10 in) 0.40–0.55 mm (0.0157–0.0217 in) 0.030–0.065 mm (0.0012–0.0026 in) 0.030–0.065 mm (0.0012–0.0026 in)	---- ---- ---- 0.95 mm (0.0374 in) 0.100 mm (0.0039 in) 0.100 mm (0.0039 in)

MAINTENANCE SPECIFICATIONS

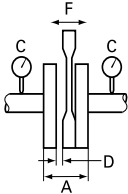
Item	Standard	Limit
Crankshaft: Crank width "A" Runout limit "C" Connecting rod big end side clearance "D" Small end free play "F" <div style="text-align: center;">  </div>	59.95–60.00 mm (2.360–2.362 in) 0.030 mm (0.0012 in) 0.250–0.750 mm (0.0098–0.0295 in) 0.40–1.00 mm (0.02–0.04 in)	---- 0.050 mm (0.0020 in) ---- 2.0 mm (0.08 in)
Clutch: Friction plate thickness Quantity Clutch plate thickness Quantity Warp limit Clutch spring free length Quantity Clutch housing thrust clearance Clutch housing radial clearance Clutch release method	2.90–3.10 mm (0.114–0.122 in) 8 1.50–1.70 mm (0.059–0.067 in) 7 ---- 50.00 mm (1.97 in) 6 0.17–0.23 mm (0.007–0.009 in) 0.03–0.05 mm (0.0012–0.0022 in) Inner push, cam push	2.80 mm (0.110 in) ---- ---- ---- 0.20 mm (0.008 in) 48.00 mm (1.89 in) ---- ---- ---- ----
Transmission: Main axle deflection limit Drive axle deflection limit	---- ----	0.01 mm (0.0004 in) 0.01 mm (0.0004 in)
Shifter: Shifting type Guide bar bending limit	Cam drum and guide bar ----	---- 0.050 mm (0.0020 in)
Kick starter type:	Kick and ratchet type	----
Air filter oil grade (oiled filter):	Foam-air-filter oil or equivalent oil	----

MAINTENANCE SPECIFICATIONS

Item	Standard			Limit
	USA, CDN	EUROPE	AUS, NZ, ZA	
Carburetor:				
Type/Manufacturer	PWK38S/ KEIHIN	←	←	----
I.D. mark	1P87 50	1P86 40	←	----
Main jet (M.J.)	#178	#180	←	----
Main air jet (M.A. J.)	#200	←	←	----
Jet needle-clip position (J.N.)	N3EW-2	N3EW-3	←	----
Main nozzle (N.J.)	ø2.9	←	←	----
Cutaway (C.A.)	#7	←	←	----
Pilot jet (P.J.)	#50	#52	←	----
Pilot air screw (P.A.S.) (for reference only)	1-1/4	2-1/4	←	----
Valve seat size (V.S.)	ø3.8 mm (0.15 in)	←	←	----
Starter jet (G.S.)	#85	←	←	----
Power jet (P.W.J.)	#50	←	←	----
Float arm height (F.H.)	5.5–7.5 mm (0.22–0.30 in)	←	←	----
Reed valve:				
Thickness	0.420 mm (0.0165 in)			----
Valve stopper height	10.3–10.7 mm (0.41–0.42 in)			----
Valve bending limit	----			0.2 mm (0.01 in)
Cooling:				
Radiator core size:				
Width	107.8 mm (4.24 in)			----
Height	240.0 mm (9.45 in)			----
Thickness	32.0 mm (1.26 in)			----
Radiator cap opening pressure	95.0–125.0 kPa (0.95–1.25 kg/cm ² , 13.8–18.1 psi)			----
Radiator capacity (total)	0.63 L (0.55 Imp qt, 0.67 US qt)			----
Water pump:				
Type	Single-suction centrifugal pump			----

MAINTENANCE SPECIFICATIONS

CHASSIS

Item	Standard	Limit
Steering system:		
Steering bearing type	Taper roller bearing	----
Front suspension:		
Front fork travel	300.0 mm (11.81 in)	----
Fork spring free length	454.0 mm (17.87 in)	449.0 mm (17.68 in)
Spring rate, STD	K=4.30 N/mm (0.44 kg/mm, 24.55 lb/in)	----
Optional spring	Yes	----
Oil capacity	515.0 cm ³ (18.13 Imp oz, 17.41 US oz)	----
Oil grade	Suspension oil "S1"	----
Inner tube outer diameter	48 mm (1.9 in)	----
Front fork top end	0 mm (0 in)	----
Rear suspension:		
Shock absorber travel	131.5 mm (5.18 in)	----
Spring free length	260.0 mm (10.24 in)	----
Fitting length	248.0 mm (9.76 in)	----
Preload length <Min.–Max.>	1.5–18 mm (0.06–0.71 in)	----
Spring rate, STD	K=48.00 N/mm (4.89 kg/mm, 274.08 lb/in)	----
Optional spring	Yes	----
Enclosed gas pressure	1,000 kPa (10.0 kg/cm ² , 142.2 psi)	----
Swingarm:		
Swingarm free play limit		
End	----	1.0 mm (0.04 in)
Side clearance	----	0.2–0.9 mm (0.01–0.04 in)
Wheel:		
Front wheel type	Spoke wheel	----
Rear wheel type	Spoke wheel	----
Front rim size/material	21 × 1.60/Aluminum	----
Rear rim size/material	19 × 2.15/Aluminum	----
Rim runout limit:		
Radial	----	2.0 mm (0.08 in)
Lateral	----	2.0 mm (0.08 in)
Drive chain:		
Type/manufacturer	DID520DMA2 SDH/DAIDO	----
Number of links	113 links + joint	----
Chain slack	48.0–58.0 mm (1.89–2.28 in)	----
Chain length (15 links)	----	242.9 mm (9.56 in)

MAINTENANCE SPECIFICATIONS

Item	Standard	Limit
Front disc brake:		
Disc outside dia.×Thickness	250 × 3.0 mm (9.8 × 0.12 in)	250 × 2.5 mm (9.8 × 0.10 in)
Pad thickness	4.4 mm (0.17 in)	1.0 mm (0.04 in)
Master cylinder inside dia.	9.52 mm (0.37 in)	----
Caliper cylinder inside dia.	22.65 mm (0.89 in) × 2	----
Brake fluid type	DOT #4	----
Rear disc brake:		
Disc outside dia.×Thickness	245 × 4.0 mm (9.6 × 0.16 in)	245 × 3.5 mm (9.6 × 0.14 in)
Deflection limit	----	0.15 mm (0.0059 in)
Pad thickness	6.4 mm (0.25 in)	1.0 mm (0.04 in)
Master cylinder inside dia.	11.0 mm (0.43 in)	----
Caliper cylinder inside dia.	25.40 mm (1.00 in) × 1	----
Brake fluid type	DOT #4	----
Brake lever and brake pedal:		
Brake lever position	95 mm (3.74 in)	----
Brake pedal height (vertical height above footrest top)	0.0 mm (0.00 in)	----
Clutch lever free play (lever end)	7.0–12.0 mm (0.28–0.47 in)	----
Throttle grip free play	3.0–5.0 mm (0.12–0.20 in)	----

ELECTRICAL

Item	Standard	Limit
Ignition system:		
Ignition timing (B.T.D.C.)	0.18 mm (0.007 in)	----
Advancer type	Electrical	----
CDI:		
Magneto-model (stator)/Manufacturer	5CU-20/YAMAHA	----
Charging coil 1 resistance (color)	720.0–1,080.0 Ω at 20 °C (68 °F) (Black-Black/Red)	----
Charging coil 2 resistance (color)	44.0–66.0 Ω at 20 °C (68 °F) (Green/Blue-Green/White)	----
Pickup coil resistance (color)	248.0–372.0 Ω at 20 °C (68 °F) (White/Blue-White/Red)	----
CDI unit-model/manufacturer	1P8-00/YAMAHA	----
Ignition coil:		
Model/manufacturer	1P8-00/YAMAHA	----
Minimum spark gap	6.0 mm (0.24 in)	----
Primary winding resistance	0.20–0.30 Ω at 20 °C (68 °F)	----
Secondary winding resistance	9.52–14.28 kΩ at 20 °C (68 °F)	----
Spark plug cap:		
Resistance	5.00 kΩ at 20 °C (68 °F)	----

TIGHTENING TORQUES

TIGHTENING TORQUES







ENGINE

TIP

△ - marked portion shall be checked for torque tightening after break-in or before each race.

Item	Thread size	Q'ty	Tightening torque	Remarks
Spark plug	M14S	1	20 Nm (2.0 m•kg, 14 ft•lb)	
Cylinder head (nut)	M8	6	25 Nm (2.5 m•kg, 18 ft•lb)	Copper washer
Cylinder head (stud)	M8	6	13 Nm (1.3 m•kg, 9.4 ft•lb)	
Cylinder (nut)	M10	4	42 Nm (4.2 m•kg, 30 ft•lb)	
Cylinder (stud)	M10	4	13 Nm (1.3 m•kg, 9.4 ft•lb)	
Power valve:				
Holder	M5	2	6 Nm (0.6 m•kg, 4.3 ft•lb)	YPVS 
Link rod	M5	2	6 Nm (0.6 m•kg, 4.3 ft•lb)	YPVS
Push rod	M5	1	5 Nm (0.5 m•kg, 3.6 ft•lb)	YPVS
Thrust plate	M5	1	6 Nm (0.6 m•kg, 4.3 ft•lb)	YPVS
Side holder	M5	4	4 Nm (0.4 m•kg, 2.9 ft•lb)	YPVS
Link lever	M4	1	4 Nm (0.4 m•kg, 2.9 ft•lb)	YPVS
Pulley	M4	2	4 Nm (0.4 m•kg, 2.9 ft•lb)	YPVS
Cover	M5	4	4 Nm (0.4 m•kg, 2.9 ft•lb)	YPVS
Governor fork	M4	2	5 Nm (0.5 m•kg, 3.6 ft•lb)	YPVS
Housing	M5	4	5 Nm (0.5 m•kg, 3.6 ft•lb)	YPVS
Impeller	M8	1	14 Nm (1.4 m•kg, 10 ft•lb)	
Water pump housing cover	M6	4	10 Nm (1.0 m•kg, 7.2 ft•lb)	
Coolant drain bolt	M6	1	10 Nm (1.0 m•kg, 7.2 ft•lb)	Copper washer
Radiator	M6	6	10 Nm (1.0 m•kg, 7.2 ft•lb)	
Radiator guard	M6	2	10 Nm (1.0 m•kg, 7.2 ft•lb)	
Radiator hose clamp	M6	8	2 Nm (0.2 m•kg, 1.4 ft•lb)	
Air filter element	M6	1	2 Nm (0.2 m•kg, 1.4 ft•lb)	
Carburetor joint	M6	5	10 Nm (1.0 m•kg, 7.2 ft•lb)	
△ Air filter case	M6	2	8 Nm (0.8 m•kg, 5.8 ft•lb)	
Air filter guide clamp	M5	1	4 Nm (0.4 m•kg, 2.9 ft•lb)	
Reed valve	M3	4	1 Nm (0.1 m•kg, 0.7 ft•lb)	
Throttle cable adjust bolt and locknut	M8	1	7 Nm (0.7 m•kg, 5.1 ft•lb)	
Throttle cable	M6	1	4 Nm (0.4 m•kg, 2.9 ft•lb)	
△ Exhaust pipe (front)	M6	1	14 Nm (1.4 m•kg, 10 ft•lb)	
△ Exhaust pipe (rear)	M6	1	12 Nm (1.2 m•kg, 8.7 ft•lb)	
△ Exhaust pipe stay (front)	M8	1	25 Nm (2.5 m•kg, 18 ft•lb)	
△ Exhaust pipe stay (rear)	M6	1	12 Nm (1.2 m•kg, 8.7 ft•lb)	
Silencer:				
△ Silencer and frame	M6	1	12 Nm (1.2 m•kg, 8.7 ft•lb)	
Fiber	M6	4	10 Nm (1.0 m•kg, 7.2 ft•lb)	
Crankcase	M6	11	14 Nm (1.4 m•kg, 10 ft•lb)	
Left crankcase cover	M6	5	5 Nm (0.5 m•kg, 3.6 ft•lb)	

TIGHTENING TORQUES



Item	Thread size	Q'ty	Tightening torque	Remarks
Drive chain sprocket cover	M6	2	5 Nm (0.5 m•kg, 3.6 ft•lb)	
Right crankcase cover	M6	9	10 Nm (1.0 m•kg, 7.2 ft•lb)	
Bearing plate cover (drive axle left)	M6	2	10 Nm (1.0 m•kg, 7.2 ft•lb)	
Bearing plate cover (main axle right)	M6	2	10 Nm (1.0 m•kg, 7.2 ft•lb)	
Holder	M6	2	10 Nm (1.0 m•kg, 7.2 ft•lb)	
Oil tank drain bolt	M12	1	23 Nm (2.3 m•kg, 17 ft•lb)	Aluminum washer
Oil check bolt	M6	1	10 Nm (1.0 m•kg, 7.2 ft•lb)	Copper washer
Neutral switch lead holder	M6	1	10 Nm (1.0 m•kg, 7.2 ft•lb)	
Kickstarter lever	M8	1	30 Nm (3.0 m•kg, 22 ft•lb)	
Ratchet wheel stopper	M6	2	10 Nm (1.0 m•kg, 7.2 ft•lb)	
Clutch cover	M6	6	10 Nm (1.0 m•kg, 7.2 ft•lb)	
Primary drive gear	M10	1	55 Nm (5.5 m•kg, 40 ft•lb)	
Clutch boss	M20	1	75 Nm (7.5 m•kg, 54 ft•lb)	Lock washer
Clutch spring	M6	6	10 Nm (1.0 m•kg, 7.2 ft•lb)	
Clutch cable adjust bolt and locknut	M6	1	4 Nm (0.4 m•kg, 2.9 ft•lb)	
Push lever axle	M5	1	6 Nm (0.6 m•kg, 4.3 ft•lb)	
Drive sprocket	M20	1	75 Nm (7.5 m•kg, 54 ft•lb)	Lock washer
Shift guide	M6	2	10 Nm (1.0 m•kg, 7.2 ft•lb)	
Stopper lever	M6	1	10 Nm (1.0 m•kg, 7.2 ft•lb)	
Torsion spring (shift shaft) stopper bolt	M8	1	22 Nm (2.2 m•kg, 16 ft•lb)	
Segment	M8	1	30 Nm (3.0 m•kg, 22 ft•lb)	
Bearing plate cover (shift cam right)	M6	2	10 Nm (1.0 m•kg, 7.2 ft•lb)	
Shift pedal	M6	1	12 Nm (1.2 m•kg, 8.7 ft•lb)	

TIGHTENING TORQUES



CHASSIS

TIP

△ - marked portion shall be checked for torque tightening after break-in or before each race.

	Item	Thread size	Q'ty	Tightening torque	Remarks
△	Upper bracket and outer tube	M8	4	21 Nm (2.1 m•kg, 15 ft•lb)	
△	Lower bracket and outer tube	M8	4	21 Nm (2.1 m•kg, 15 ft•lb)	
△	Upper bracket and steering stem	M24	1	145 Nm (14.5 m•kg, 105 ft•lb)	
△	Handlebar upper holder	M8	4	28 Nm (2.8 m•kg, 20 ft•lb)	
△	Handlebar lower holder	M12	2	40 Nm (4.0 m•kg, 22 ft•lb)	
△	Steering ring nut	M28	1	Refer to TIP.	
	Front fork and damper assembly	M51	2	30 Nm (3.0 m•kg, 22 ft•lb)	
	Front fork and adjuster	M22	2	55 Nm (5.5 m•kg, 40 ft•lb)	Copper washer 
	Damper assembly and base valve	M42	2	29 Nm (2.9 m•kg, 21 ft•lb)	
	Adjuster and damper assembly	M12	2	29 Nm (2.9 m•kg, 21 ft•lb)	
	Bleed screw (front fork) and base valve	M5	2	1 Nm (0.1 m•kg, 0.7 ft•lb)	
△	Front fork and front fork protector	M6	6	5 Nm (0.5 m•kg, 3.6 ft•lb)	
△	Front fork protector and brake hose holder	M6	2	8 Nm (0.8 m•kg, 5.8 ft•lb)	
	Throttle cable cap	M4	2	0.5 Nm (0.05 m•kg, 0.36 ft•lb)	
	Grip cap upper and lower	M6	2	4 Nm (0.4 m•kg, 2.9 ft•lb)	
	Clutch lever mounting nut	M6	1	4 Nm (0.4 m•kg, 2.9 ft•lb)	
	Clutch lever holder	M6	2	5 Nm (0.5 m•kg, 3.6 ft•lb)	
	Clutch lever position locknut	M5	1	5 Nm (0.5 m•kg, 3.6 ft•lb)	
	Engine stop switch screw	M3	1	0.5 Nm (0.05 m•kg, 0.36 ft•lb)	
△	Front brake master cylinder and bracket	M6	2	9 Nm (0.9 m•kg, 6.5 ft•lb)	
	Front brake master cylinder cap	M4	2	2 Nm (0.2 m•kg, 1.4 ft•lb)	
	Brake lever mounting bolt	M6	1	6 Nm (0.6 m•kg, 4.3 ft•lb)	
	Brake lever mounting nut	M6	1	6 Nm (0.6 m•kg, 4.3 ft•lb)	
	Brake lever position locknut	M6	1	5 Nm (0.5 m•kg, 3.6 ft•lb)	
△	Cable guide (front brake hose) and lower bracket	M6	1	4 Nm (0.4 m•kg, 2.9 ft•lb)	
△	Front brake hose union bolt (brake master cylinder)	M10	1	30 Nm (3.0 m•kg, 22 ft•lb)	Copper washer
△	Front brake hose union bolt (caliper)	M10	1	30 Nm (3.0 m•kg, 22 ft•lb)	Copper washer
△	Front brake caliper and front fork	M	2	28 Nm (2.8 m•kg, 20 ft•lb)	
	Brake caliper (front and rear) and pad pin plug	M10	2	3 Nm (0.3 m•kg, 2.2 ft•lb)	
△	Brake caliper (front and rear) and pad pin	M10	2	18 Nm (1.8 m•kg, 13 ft•lb)	
△	Brake caliper (front and rear) and bleed screw	M8	2	6 Nm (0.6 m•kg, 4.3 ft•lb)	
△	Front wheel axle and axle nut	M16	1	105 Nm (10.5 m•kg, 75 ft•lb)	
△	Front wheel axle holder	M8	4	21 Nm (2.1 m•kg, 15 ft•lb)	
△	Front brake disc and wheel hub	M6	6	12 Nm (1.2 m•kg, 8.7 ft•lb)	
△	Rear brake disc and wheel hub	M6	6	14 Nm (1.4 m•kg, 10 ft•lb)	

TIGHTENING TORQUES

	Item	Thread size	Q'ty	Tightening torque	Remarks
	Footrest bracket and frame	M10	4	55 Nm (5.5 m•kg, 40 ft•lb)	TORX 
△	Brake pedal mounting	M8	1	26 Nm (2.6 m•kg, 19 ft•lb)	
△	Rear brake master cylinder and frame	M6	2	10 Nm (1.0 m•kg, 7.2 ft•lb)	
	Rear brake master cylinder cap	M4	2	2 Nm (0.2 m•kg, 1.4 ft•lb)	
△	Rear brake hose union bolt (caliper)	M10	1	30 Nm (3.0 m•kg, 22 ft•lb)	Copper washer
△	Rear brake hose union bolt (master cylinder)	M10	1	30 Nm (3.0 m•kg, 22 ft•lb)	Copper washer
△	Rear wheel axle and axle nut	M20	1	125 Nm (12.5 m•kg, 90 ft•lb)	
△	Driven sprocket and wheel hub	M8	6	42 Nm (4.2 m•kg, 30 ft•lb)	
△	Nipple (spoke)	—	72	3 Nm (0.3 m•kg, 2.2 ft•lb)	
△	Disc cover and rear brake caliper	M6	2	10 Nm (1.0 m•kg, 7.2 ft•lb)	
△	Protector and rear brake caliper	M6	2	7 Nm (0.7 m•kg, 5.1 ft•lb)	
	Drive chain puller adjust bolt and locknut	M8	2	19 Nm (1.9 m•kg, 13 ft•lb)	
	Engine:				
△	Engine bracket and frame	M8	2	34 Nm (3.4 m•kg, 24 ft•lb)	
△	Engine and frame (front)	M10	1	64 Nm (6.4 m•kg, 46 ft•lb)	
△	Engine bracket and engine	M10	1	64 Nm (6.4 m•kg, 46 ft•lb)	
△	Engine and frame (lower)	M10	1	64 Nm (6.4 m•kg, 46 ft•lb)	
△	Pivot shaft and nut	M16	1	85 Nm (8.5 m•kg, 61 ft•lb)	
△	Relay arm and swingarm	M14	1	70 Nm (7.0 m•kg, 50 ft•lb)	
△	Relay arm and connecting rod	M14	1	80 Nm (8.0 m•kg, 58 ft•lb)	
△	Connecting rod and frame	M14	1	80 Nm (8.0 m•kg, 58 ft•lb)	
△	Rear shock absorber and frame	M10	1	56 Nm (5.6 m•kg, 40 ft•lb)	
△	Rear shock absorber and relay arm	M10	1	53 Nm (5.3 m•kg, 38 ft•lb)	
	Rear shock absorber adjust locknut	M56	1	30 Nm (3.0 m•kg, 22 ft•lb)	
△	Rear frame and frame (upper)	M8	1	32 Nm (3.2 m•kg, 23 ft•lb)	
△	Rear frame and frame (lower)	M8	2	29 Nm (2.9 m•kg, 21 ft•lb)	
△	Swingarm and brake hose holder	M5	4	3 Nm (0.3 m•kg, 2.2 ft•lb)	
	Swingarm and patch	M4	4	2 Nm (0.2 m•kg, 1.4 ft•lb)	
	Drive chain tensioner	M8	2	16 Nm (1.6 m•kg, 11 ft•lb)	
	Drive chain support and swingarm	M6	3	7 Nm (0.7 m•kg, 5.1 ft•lb)	
	Seal guard and swingarm	M5	4	6 Nm (0.6 m•kg, 4.3 ft•lb)	
	Cable guide and frame	M5	2	4 Nm (0.4 m•kg, 2.9 ft•lb)	
△	Fuel tank boss and frame	M10	2	20 Nm (2.0 m•kg, 14 ft•lb)	
△	Fuel tank	M6	2	10 Nm (1.0 m•kg, 7.2 ft•lb)	
△	Fuel tank and fuel cock	M6	2	4 Nm (0.4 m•kg, 2.9 ft•lb)	
	Fuel tank and seat set bracket	M6	1	7 Nm (0.7 m•kg, 5.1 ft•lb)	
	Fuel tank and hooking screw (fitting band)	M6	1	7 Nm (0.7 m•kg, 5.1 ft•lb)	
	Fuel tank and fuel tank bracket	M6	4	7 Nm (0.7 m•kg, 5.1 ft•lb)	
△	Seat	M8	2	19 Nm (1.9 m•kg, 13 ft•lb)	
△	Side cover	M6	2	7 Nm (0.7 m•kg, 5.1 ft•lb)	
△	Air scoop and fuel tank	M6	4	7 Nm (0.7 m•kg, 5.1 ft•lb)	
△	Air scoop and radiator guard (lower)	M6	2	6 Nm (0.6 m•kg, 4.3 ft•lb)	

TIGHTENING TORQUES

	Item	Thread size	Q'ty	Tightening torque	Remarks
△	Front fender	M6	4	10 Nm (1.0 m•kg, 7.2 ft•lb)	
△	Rear fender (front)	M6	2	7 Nm (0.7 m•kg, 5.1 ft•lb)	
△	Rear fender (rear)	M6	2	12 Nm (1.2 m•kg, 8.7 ft•lb)	
△	Mud flap	—	2	1 Nm (0.1 m•kg, 0.7 ft•lb)	
△	Number plate	M6	1	7 Nm (0.7 m•kg, 5.1 ft•lb)	

TIP

1. First, tighten the steering ring nut approximately 38 Nm (3.8 m•kg, 27 ft•lb) by using the steering nut wrench, then loosen the steering ring nut one turn.
2. Retighten the steering ring nut 7 Nm (0.7 m•kg, 5.1 ft•lb).

ELECTRICAL

	Item	Thread size	Q'ty	Tightening torque	Remarks
	Stator	M6	3	7 Nm (0.7 m•kg, 5.1 ft•lb)	
	Rotor	M12	1	56 Nm (5.6 m•kg, 40 ft•lb)	
	Ignition coil	M6	2	7 Nm (0.7 m•kg, 5.1 ft•lb)	
	Neutral switch	M5	2	4 Nm (0.4 m•kg, 2.9 ft•lb)	

TIGHTENING TORQUES

GENERAL TORQUE SPECIFICATIONS

This chart specifies torque for standard fasteners with standard I.S.O. pitch threads. Torque specifications for special components or assemblies are included in the applicable sections of this book. To avoid warpage, tighten multi-fastener assemblies in a crisscross fashion, in progressive stages, until full torque is reached. Unless otherwise specified, torque specifications call for clean, dry threads. Components should be at room temperature.

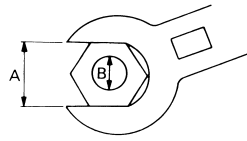

- A. Distance between flats
- B. Outside thread diameter

A (Nut)	B (Bolt)	TORQUE SPECIFICATION		
		Nm	m•kg	ft•lb
10 mm	6 mm	6	0.6	4.3
12 mm	8 mm	15	1.5	11
14 mm	10 mm	30	3.0	22
17 mm	12 mm	55	5.5	40
19 mm	14 mm	85	8.5	61
22 mm	16 mm	130	13	94

DEFINITION OF UNITS

Unit	Read	Definition	Measure
mm	millimeter	10^{-3} meter	Length
cm	centimeter	10^{-2} meter	Length
kg	kilogram	10^3 gram	Weight
N	Newton	$1 \text{ kg} \times \text{m}/\text{sec}^2$	Force
Nm	Newton meter	$\text{N} \times \text{m}$	Torque
m•kg	Meter kilogram	$\text{m} \times \text{kg}$	Torque
Pa	Pascal	N/m^2	Pressure
N/mm	Newton per millimeter	N/mm	Spring rate
L	Liter	—	Volume or capacity
cm ³	Cubic centimeter	—	Volume or capacity
r/min	Revolution per minute	—	Engine speed

CABLE ROUTING DIAGRAM

CABLE ROUTING DIAGRAM

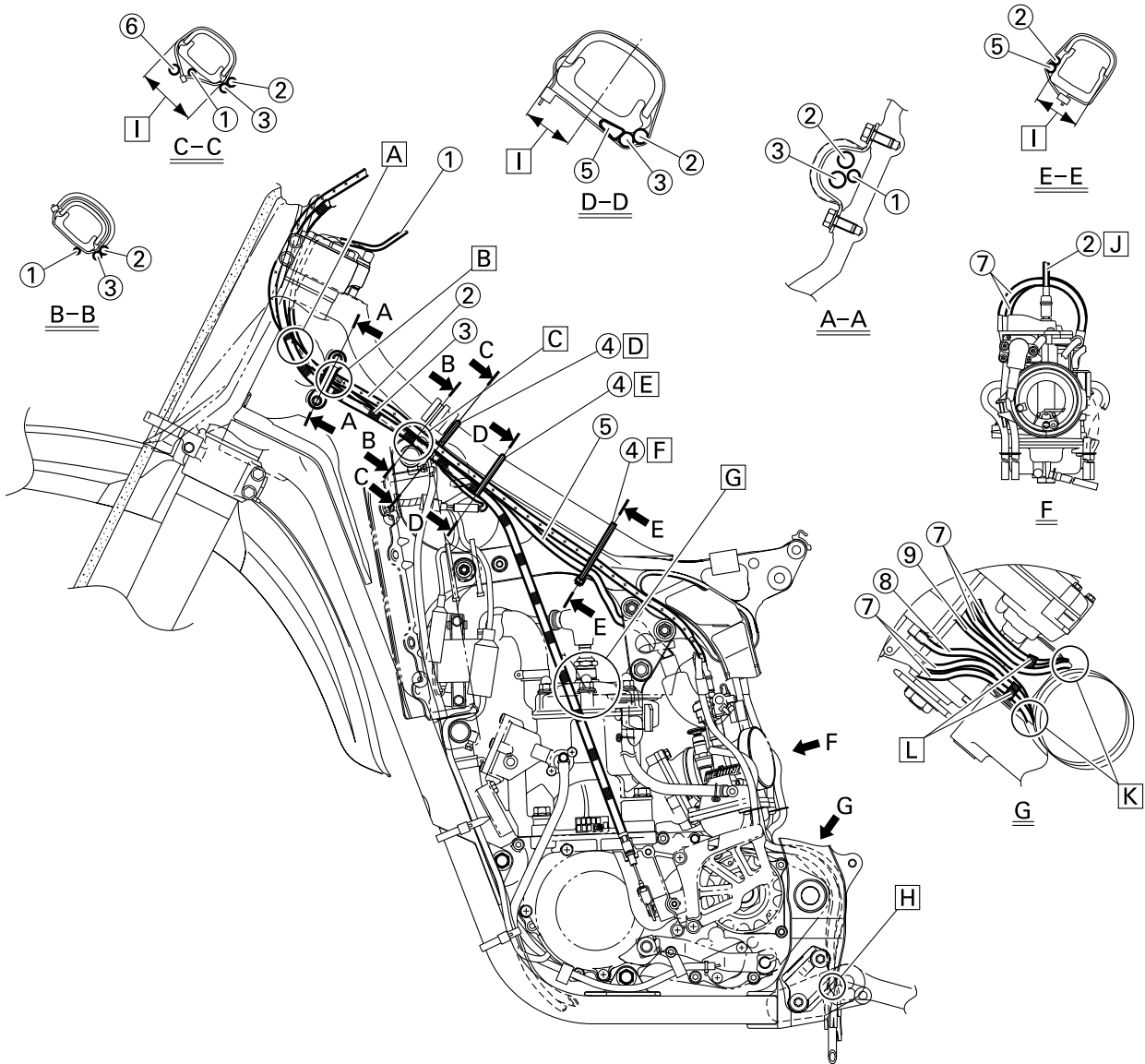

- 1. Engine stop switch lead
- 2. Throttle cable
- 3. Clutch cable
- 4. Clamp
- 5. Wire harness
- 6. Radiator breather hose
- 7. Air vent hose
- 8. Crankcase breather hose
- 9. Overflow hose

- A. Pass the clutch cable on the outside of the throttle cable and engine stop switch lead.
- B. Align the throttle cable locating tape with the cable guide.
- C. Pass the throttle cable, clutch cable and engine stop switch lead above the radiator hose.

- D. Clamp the engine stop switch lead to the frame. Tighten the clamp so that the engine stop switch lead is not pulled when the handlebar is turned to the right and left.
- E. Clamp the throttle cable, clutch cable and wire harness to the frame.

CABLE ROUTING DIAGRAM

- F. Clamp the throttle cable and wire harness to the frame.
- G. Pass the clutch cable in front of the center of the cylinder head tightening nut.
- H. Pass the air vent hose, overflow hose and crankcase breather hose between the frame and connecting rod.
- I. Locate the clamp ends in the arrowed range.
- J. Pass the throttle cable behind the air vent hose.
- K. Pass the air vent hose, overflow hose and crankcase breather hose so that they do not contact the rear shock absorber.
- L. Clamp the air vent hoses.

CABLE ROUTING DIAGRAM

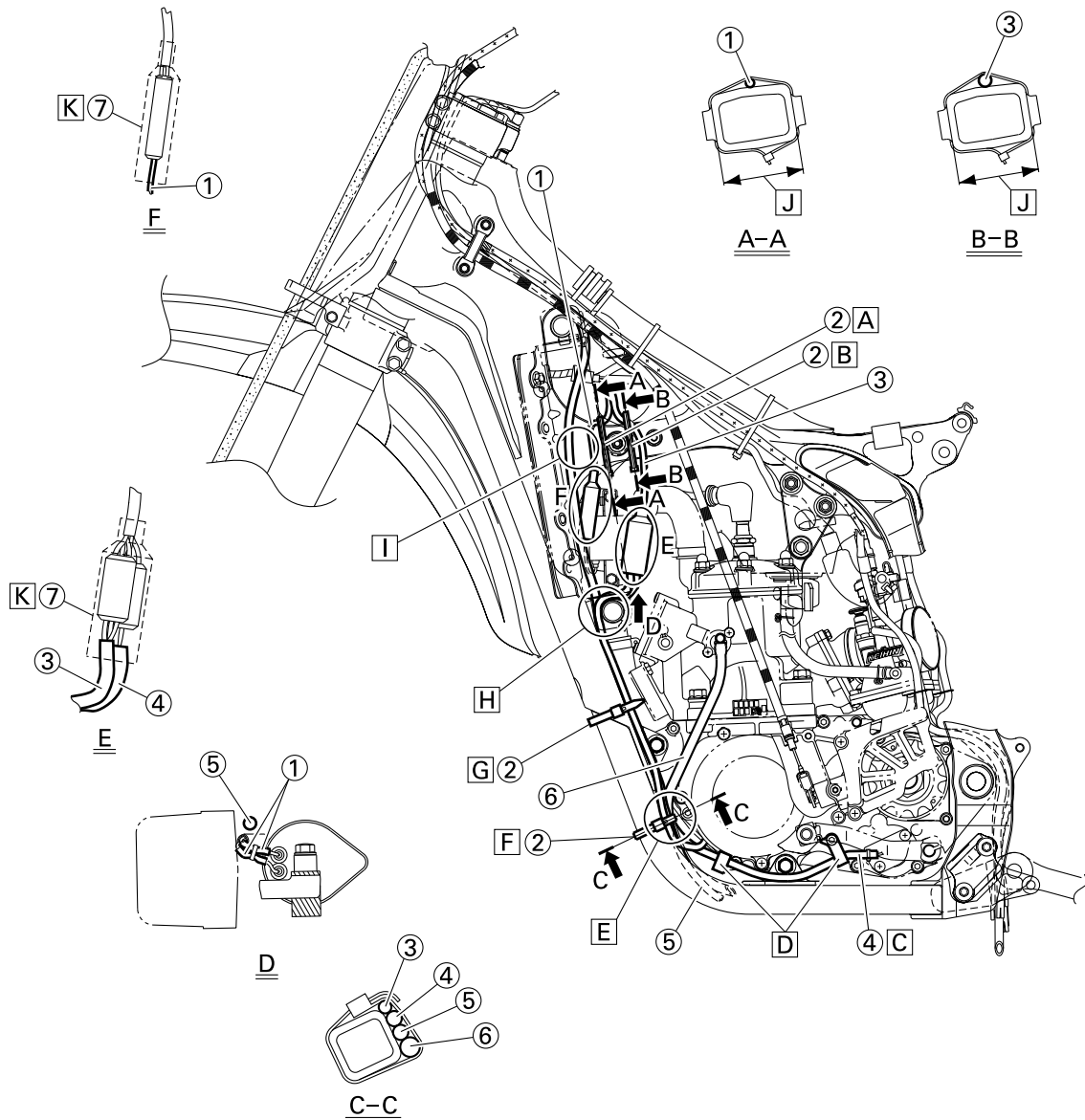

1. Ignition coil lead
2. Clamp
3. CDI magneto lead
4. Neutral switch lead
5. Radiator breather hose
6. YPVS breather hose
7. Connector cover

- A. Clamp the ignition coil lead to the frame at its locating tape. Clamp it in front of the radiator fitting boss.
- B. Clamp the CDI magneto lead to the frame at its locating tape. Clamp it at the rear of the radiator fitting boss.
- C. Do not allow the neutral switch lead to slacken except over the radiator hose.

- D. Pass the neutral switch lead through the holder.
- E. Pass the radiator breather hose outside the engine bracket and inside the down tube. Then pass the radiator breather hose inside the CDI magneto lead.
- F. Clamp the CDI magneto lead, radiator breather hose, YPVS breather hose and neutral switch lead to the frame.

CABLE ROUTING DIAGRAM

- G. Clamp the radiator breather hose, CDI magneto lead and neutral switch lead to the frame.
- H. Pass the CDI magneto lead, radiator breather hose and neutral switch lead in front of the radiator hose. Then pass the radiator breather hose inside the CDI magneto lead and neutral switch lead.
- I. Pass the radiator breather hose and ignition coil lead between the frame and the radiator (left).
- J. Locate the clamp ends in the arrowed range.
- K. Bring the connector cover into contact with the coupler.

CABLE ROUTING DIAGRAM

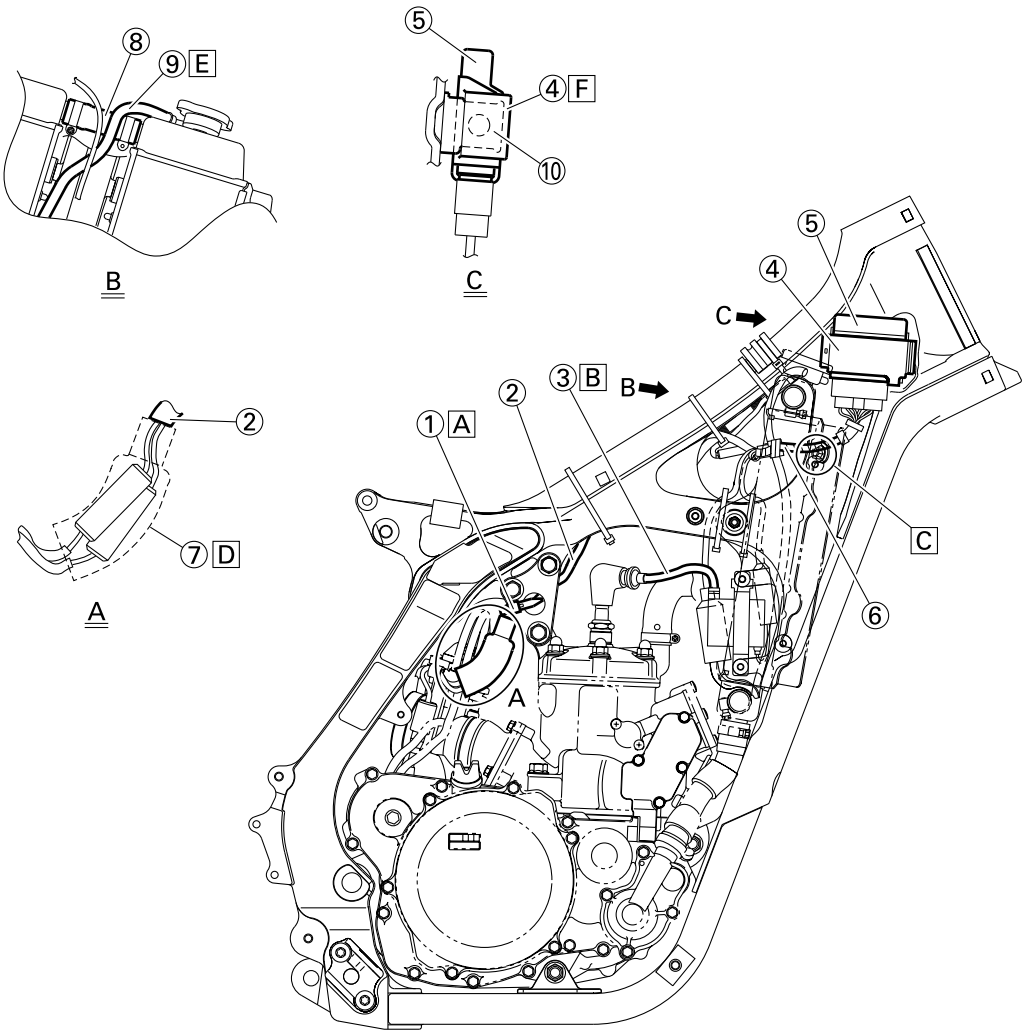

- 1. Clamp
- 2. Wire harness
- 3. High tension cord
- 4. CDI unit band
- 5. CDI unit
- 6. CDI unit lead
- 7. Connector cover
- 8. Radiator hose
- 9. Radiator breather hose
- 10. CDI unit stay

- A. Clamp the wire harness protecting tube to the right engine bracket.
- B. Pass the high tension cord to the right of the radiator hose so that the high tension cord does not contact the radiator hose.
- C. Pass the CDI unit lead between the frame and the radiator (right) and then above the radiator fitting boss.

- D. Bring the connector cover into contact with the coupler.
- E. Pass the radiator breather hose behind the radiator hose.
- F. Insert the CDI unit band until it stops at the CDI unit stay.

CABLE ROUTING DIAGRAM

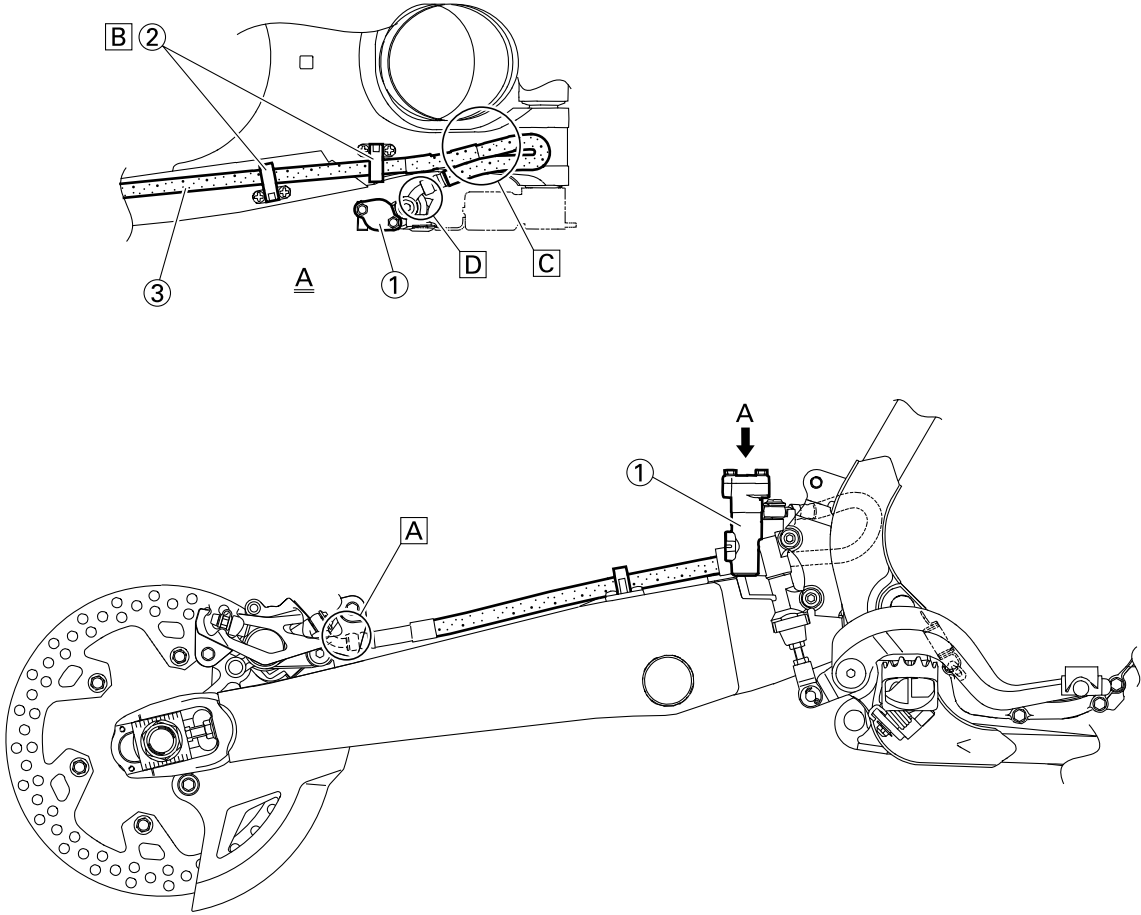

- 1. Master cylinder
- 2. Brake hose holder
- 3. Brake hose

- A. Install the brake hose so that its pipe portion directs as shown and lightly touches the projection on the caliper.
- B. Pass the brake hose into the brake hose holders.
- C. If the brake hose contacts the spring (rear shock absorber), correct its twist.

- D. Install the brake hose so that its pipe portion directs as shown and lightly touches the projection on the master cylinder.

CABLE ROUTING DIAGRAM

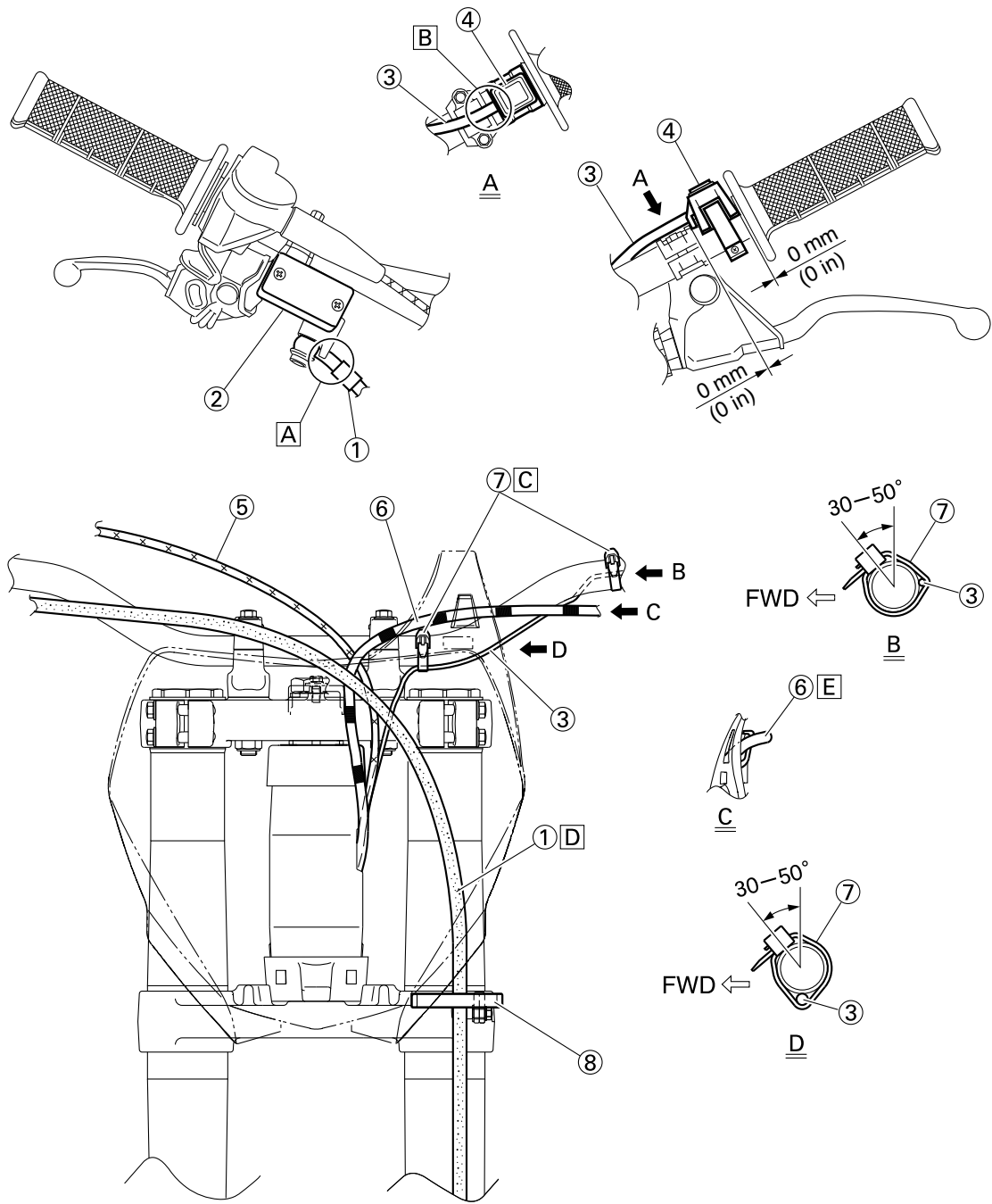

- 1. Brake hose
- 2. Master cylinder
- 3. Engine stop switch lead
- 4. Engine stop switch
- 5. Throttle cable
- 6. Clutch cable
- 7. Clamp
- 8. Cable guide

- A. Install the brake hose so that its pipe portion directs as shown and lightly touches the projection on the master cylinder.
- B. Pass the engine stop switch lead in the middle of the clutch holder.
- C. Clamp the engine stop switch lead to the handlebar.

- D. Pass the brake hose in front of the number plate and through the cable guide.
- E. Pass the clutch cable through the cable guide on the number plate.

MAINTENANCE INTERVALS

REGULAR INSPECTION AND ADJUSTMENTS MAINTENANCE INTERVALS

TIP

- The following schedule is intended as a general guide to maintenance and lubrication. Bear in mind that such factors as weather, terrain, geographical location, and individual usage will alter the required maintenance and lubrication intervals. If you are a doubt as to what intervals to follow in maintaining and lubricating your machine, consult your Yamaha dealer.
- Periodic inspection is essential in making full use of the machine performance. The service life of the parts varies substantially according to the environment in which the machine runs (e.g., rain, dirt, etc.). Therefore, earlier inspection is required by reference to the list below.

Item	After break-in	Every race (about 2.5 hours)	Every third (about 7.5 hours)	Every fifth (about 12.5 hours)	As required	Remarks
PISTON Inspect and clean Replace	●	●		●	●	Inspect crack. Inspect carbon deposits and eliminate them.
PISTON RING Inspect Replace	●	●	●		●	Check ring end gap.
PISTON PIN, SMALL END BEARING Inspect Replace		●			●	
CYLINDER HEAD Inspect and clean Retighten	● ●	● ●				Inspect carbon deposits and eliminate them. Check gasket.
CYLINDER Inspect and clean Replace	●	●			●	Inspect score marks. Inspect wear.
YPVS Inspect and clean	●	●				Inspect carbon deposits and eliminate them.
CLUTCH Inspect and adjust Replace	●	●			●	Inspect housing, friction plate, clutch plate and spring.
TRANSMISSION Replace oil Inspect Replace bearing	●			●	● ●	Recommended brand: YAMA-LUBE SAE10W-40 API service SG type or higher JASO standard MA
SHIFT FORK, SHIFT CAM, GUIDE BAR Inspect					●	Inspect wear.

MAINTENANCE INTERVALS

Item	After break-in	Every race (about 2.5 hours)	Every third (about 7.5 hours)	Every fifth (about 12.5 hours)	As re- quired	Remarks
ROTOR NUT Retighten	●			●		
MUFFLER Inspect Clean Retighten Replace fiber	●	●		●	● *	* When the exhaust sound becomes louder or when a performance drop is felt.
CRANK Inspect and clean				●	●	
CARBURETOR Inspect, adjust and clean	●	●				
SPARK PLUG Inspect and clean Replace	●		●		●	
DRIVE CHAIN Lubricate, slack, alignment Replace	●	●			●	Use chain lube. Chain slack: 48.0–58.0 mm (1.89–2.28 in)
COOLING SYSTEM Check coolant level and leakage Check radiator cap operation Replace coolant Inspect hoses	●	●			● ●	Every two years
OUTSIDE NUTS AND BOLTS Retighten	●	●				Refer to "STARTING AND BREAK-IN" section in the CHAPTER 1.
AIR FILTER Clean and lubricate Replace	●	●			●	Use foam air-filter oil or equivalent oil.
FRAME Clean and inspect	●	●				
FUEL TANK, COCK Clean and inspect	●		●			

MAINTENANCE INTERVALS

Item	After break-in	Every race (about 2.5 hours)	Every third (about 7.5 hours)	Every fifth (about 12.5 hours)	As required	Remarks
BRAKES						
Adjust lever position and pedal height	●	●				
Lubricate pivot point	●	●				
Check brake disc surface	●	●				
Check fluid level and leakage	●	●				
Retighten brake disc bolts, caliper bolts, master cylinder bolts and union bolts	●	●				
Replace pads					●	
Replace brake fluid					●	Every one year
FRONT FORKS						
Inspect and adjust	●	●				
Replace oil	●			●		Suspension oil "S1"
Replace oil seal					●	
FRONT FORK OIL SEAL AND DUST SEAL						
Clean and lube	●	●				Lithium base grease
PROTECTOR GUIDE						
Replace					●	
REAR SHOCK ABSORBER						
Inspect and adjust	●	●				
Lube			●		●	(After rain ride)
Retighten	●	●				Molybdenum disulfide grease
DRIVE CHAIN GUIDE AND ROLLERS						
Inspect	●	●				
SWINGARM						
Inspect, lube and retighten	●	●				Molybdenum disulfide grease
RELAY ARM, CONNECTING ROD						
Inspect, lube and retighten	●	●				Molybdenum disulfide grease
STEERING HEAD						
Inspect free play and retighten	●	●				
Clean and lube				●		Lithium base grease
Replace bearing					●	

MAINTENANCE INTERVALS

Item	After break-in	Every race (about 2.5 hours)	Every third (about 7.5 hours)	Every fifth (about 12.5 hours)	As re- quired	Remarks
TIRE, WHEELS						
Inspect air pressure, wheel runout, tire wear and spoke looseness	●	●				
Retighten sprocket bolt	●	●				
Inspect bearings			●			
Replace bearings					●	
Lubricate			●			Lithium base grease
THROTTLE, CONTROL CABLE						
Check routing and connection	●	●				
Lubricate	●	●				Yamaha cable lube or SAE 10W-40 motor oil

PRE-OPERATION INSPECTION AND MAINTENANCE

PRE-OPERATION INSPECTION AND MAINTENANCE

Before riding for break-in operation, practice or a race, make sure the machine is in good operating condition.

Before using this machine, check the following points.

GENERAL INSPECTION AND MAINTENANCE

Item	Routine	Page
Coolant	Check that coolant is filled up to the radiator cap. Check the cooling system for leakage.	P.3-6 – 7
Fuel	Check that a fresh mixture of oil and gasoline is filled in the fuel tank. Check the fuel line for leakage.	P.1-11 – 12
Transmission oil	Check that the oil level is correct. Check the crankcase for leakage.	P.3-8 – 9
Gear shifter and clutch	Check that gears can be shifted correctly in order and that the clutch operates smoothly.	P.3-7
Throttle grip/Housing	Check that the throttle grip operation and free play are correctly adjusted. Lubricate the throttle grip and housing, if necessary.	P.3-7 – 8
Brakes	Check the play of front brake and effect of front and rear brake.	P.3-10 – 12
Drive chain	Check drive chain slack and alignment. Check that the drive chain is lubricated properly.	P.3-13 – 14
Wheels	Check for excessive wear and tire pressure. Check for loose spokes and have no excessive play.	P.3-16 – 17
Steering	Check that the handlebar can be turned smoothly and have no excessive play.	P.3-17 – 18
Front forks and rear shock absorber	Check that they operate smoothly and there is no oil leakage.	P.3-14 – 16
Cables (wires)	Check that the clutch and throttle cables move smoothly. Check that they are not caught when the handlebars are turned or when the front forks travel up and down.	—
Muffler	Check that the muffler is tightly mounted and has no cracks.	P.4-3 – 4
Rear wheel sprocket	Check that the rear wheel sprocket tightening bolt is not loose.	P.3-12 – 13
Lubrication	Check for smooth operation. Lubricate if necessary.	P.3-19
Bolts and nuts	Check the chassis and engine for loose bolts and nuts.	P.1-13
Lead connectors	Check that the CDI magneto, CDI unit, and ignition coil are connected tightly.	P.1-7
Settings	Is the machine set suitably for the condition of the racing course and weather or by taking into account the results of test runs before racing? Are inspection and maintenance completely done?	P.7-1 – 11

ENGINE

CHECKING THE COOLANT LEVEL

⚠ WARNING

Do not remove the radiator cap "1", drain bolt and hoses when the engine and radiator are hot. Scalding hot fluid and steam may be blown out under pressure, which could cause serious injury. When the engine has cooled, place a thick towel over the radiator cap, slowly rotate the cap counterclockwise to the detent. This procedure allows any residual pressure to escape. When the hissing sound has stopped, press down on the cap while turning counterclockwise and remove it.

NOTICE

Hard water or salt water is harmful to the engine parts. You may use distilled water, if you can't get soft water.

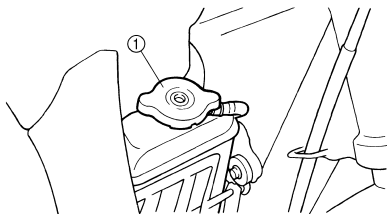

- Place the machine on a level place, and hold it in an upright position.
- Remove:
 - Radiator cap
- Check:
 - Coolant level "a"
 Coolant level low → Add coolant.

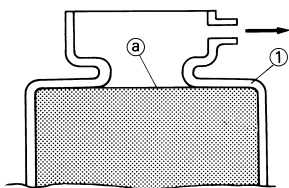

- Radiator

CHANGING THE COOLANT

⚠ WARNING

Do not remove the radiator cap when the engine is hot.

NOTICE

Take care so that coolant does not splash on painted surfaces. If it splashes, wash it away with water.

- Place a container under the engine.

- Remove:
 - Coolant drain bolt "1"

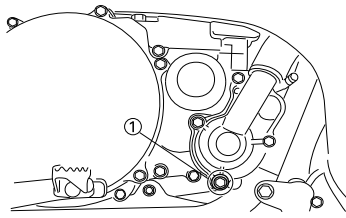

- Remove:
 - Radiator cap
 Drain the coolant completely.
- Clean:
 - Cooling system
 Thoroughly flush the cooling system with clean tap water.
- Install:
 - Copper washer **New**
 - Coolant drain bolt

	Coolant drain bolt: 10 Nm (1.0 m•kg, 7.2 ft•lb)
---	---

- Fill:
 - Radiator
 - Engine
 To specified level.

	Recommended coolant: High quality ethylene glycol anti-freeze containing anti-corrosion for aluminum engine Coolant "1" and water (soft water) "2" mixing ratio: 50%/50% Coolant capacity: 1.20 L (1.06 Imp qt, 1.27 US qt)
---	---

NOTICE

- Do not mix more than one type of ethylene glycol antifreeze containing corrosion inhibitors for aluminum engine.
- Do not use water containing impurities or oil.

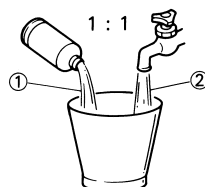

323-020



Handling notes of coolant:

The coolant is harmful so it should be handled with special care.

⚠ WARNING

- When coolant splashes to your eye.
Thoroughly wash your eye with water and see your doctor.
- When coolant splashes to your clothes.
Quickly wash it away with water and then with soap.
- When coolant is swallowed.
Quickly make him vomit and take him to a doctor.



- Install:
 - Radiator cap
 Start the engine and warm it up for a several minutes.
- Check:
 - Coolant level
 Coolant level low → Add coolant.

CHECKING THE RADIATOR CAP

- Inspect:
 - Seal (radiator cap) "1"
 - Valve and valve seat "2"
 Crack/damage → Replace.
Exist fur deposits "3" → Clean or replace.

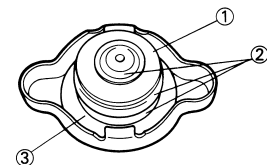

CHECKING THE RADIATOR CAP OPENING PRESSURE

- Attach:
 - Radiator cap tester "1" and adapter "2"

	Radiator cap tester: YU-24460-A/90890-01325 Radiator cap tester adapter: YU-33984/90890-01352
---	--

TIP

Apply water on the radiator cap seal.

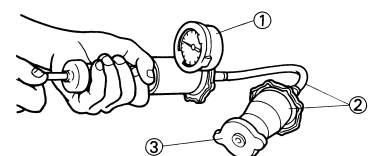

- Radiator cap

2. Apply the specified pressure.

	Radiator cap opening pressure: 95.0–125.0 kPa (0.95–1.25 kg/cm ² , 13.8–18.1 psi)
---	--

3. Inspect:

- Pressure
Impossible to maintain the specified pressure for 10 seconds → Replace.

CHECKING THE COOLING SYSTEM

1. Inspect:

- Coolant level

2. Attach:

- Radiator cap tester "1" and adapter "2"

	Radiator cap tester: YU-24460-A/90890-01325 Radiator cap tester adapter: YU-33984/90890-01352
---	--

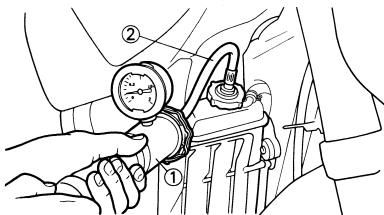

3. Apply the specified pressure.

	Standard pressure: 180.0 kPa (1.80 kg/cm ² , 26.1 psi)
---	---

TIP

- Do not apply pressure more than specified pressure.
- Radiator should be filled fully.

4. Inspect:

- Pressure
Impossible to maintain the specified pressure for 10 seconds → Repair.
- Radiator "1"
- Radiator hose joint "2"
Coolant leakage → Repair or replace.
- Radiator hose "3"
Swelling → Replace.

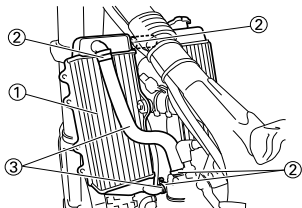

ADJUSTING THE CLUTCH LEVER POSITION

1. Adjust:

- Clutch lever position

Clutch lever position adjustment steps:

a. Loosen the locknuts "1".
b. Turn the adjusting bolt "2" until the clutch lever position "a" is in the desired position.

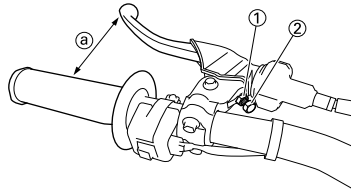

c. Tighten the locknuts.

	Locknut: 5 Nm (0.5 m•kg, 3.6 ft•lb)
---	---

2. Adjust:

- Clutch lever free play
Refer to "ADJUSTING THE CLUTCH LEVER FREE PLAY".

ADJUSTING THE CLUTCH LEVER FREE PLAY

1. Check:

- Clutch lever free play "a"
Out of specification → Adjust.

	Clutch lever free play "a": 7.0–12.0 mm (0.28–0.47 in)
---	--

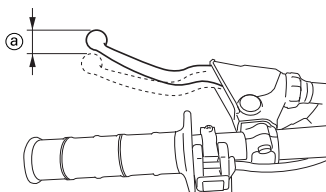

2. Adjust:

- Clutch lever free play

Handlebar side

a. Turn the adjuster "1" until the specified clutch lever free play is obtained.

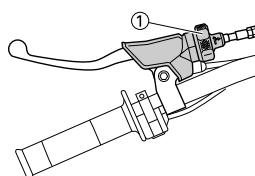

TIP

If the clutch lever free play cannot be obtained on the handlebar side, use the adjuster on the clutch cable side.



Clutch cable side

a. Slide the clutch cable cover.
b. Loosen the locknut "1".
c. Turn the adjuster "2" until the specified clutch lever free play is obtained.
d. Tighten the locknut.

	Locknut: 4 Nm (0.4 m•kg, 2.9 ft•lb)
---	---

e. Return the clutch cable cover to its original position.

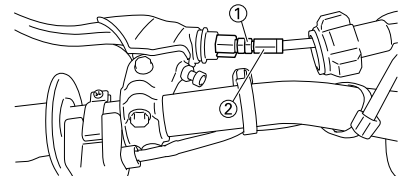

ADJUSTING THE THROTTLE GRIP FREE PLAY

1. Check:

- Throttle grip free play "a"
Out of specification → Adjust.

	Throttle grip free play "a": 3.0–5.0 mm (0.12–0.20 in)
---	--

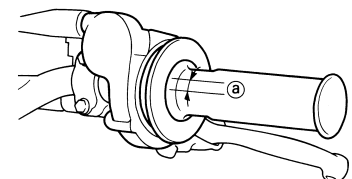

2. Adjust:

- Throttle grip free play

Adjustment steps:

a. Slide the adjuster cover.
b. Loosen the locknut "1".
c. Turn the adjuster "2" until the specified free play is obtained.
d. Tighten the locknut.

	Locknut: 7 Nm (0.7 m•kg, 5.1 ft•lb)
---	---

TIP

Prior to adjusting throttle grip free play, the engine idling speed should be adjusted.

WARNING

After adjusting the throttle grip free play, turn the handlebar to the right and to the left to ensure that this does not cause the engine idling speed to change.

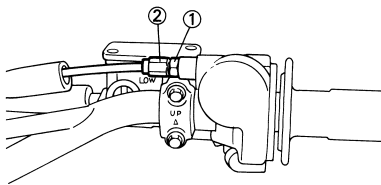

LUBRICATING THE THROTTLE

1. Remove:

- Cap cover "1"
- Throttle cable cap "2"

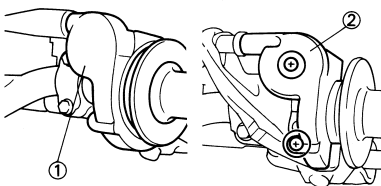

2. Apply:

- Lithium soap base grease
On the throttle cable end "a", tube guide cable winding portion "b" and roller sliding surface "c".

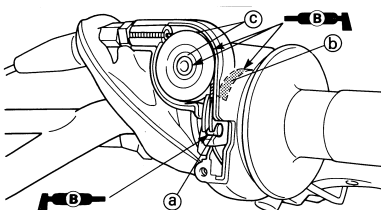

3. Install:

- Throttle cable cap

	Throttle cable cap: 0.5 Nm (0.05 m•kg, 0.36 ft•lb)
---	--

- Cap cover

CLEANING THE AIR FILTER ELEMENT

TIP

Proper air filter maintenance is the biggest key to preventing premature engine wear and damage.

NOTICE

Never run the engine without the air filter element in place; this would allow dirt and dust to enter the engine and cause rapid wear and possible engine damage.

1. Remove:

- Seat
- Fitting bolt "1"
- Washer "2"
- Air filter element "3"
- Air filter guide "4"

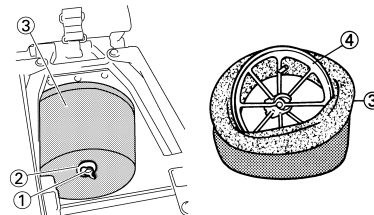

2. Clean:

- Air filter element
Clean them with solvent.

TIP

After cleaning, remove the remaining solvent by squeezing the element.

NOTICE

- Do not twist the element when squeezing the element.
- Leaving too much of solvent in the element may result in poor starting.

3. Inspect:

- Air filter element
Damage → Replace.

4. Apply:

- Foam-air-filter oil or equivalent oil to the element

TIP

Squeeze out the excess oil. Element should be wet but not dripping.

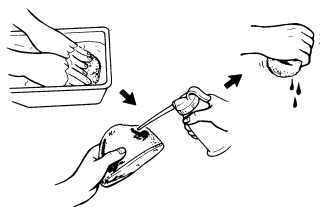

5. Install:

- Air filter guide "1"

TIP

Align the projection "a" on filter guide with the hole "b" in air filter element.

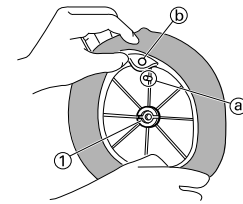

6. Apply:

- Lithium soap base grease
On the matching surface "a" on air filter element.

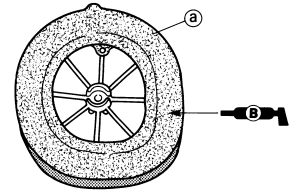

7. Install:

- Air filter element "1"
- Washer
- Fitting bolt



Fitting bolt:

2 Nm (0.2 m•kg, 1.4 ft•lb)

TIP

Align the projection "a" on filter guide with the hole "b" in air filter case.

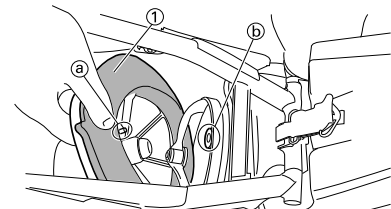

CHECKING THE TRANSMISSION OIL LEVEL

1. Start the engine, warm it up for several minutes and wait for five minutes.
2. Place the machine on a level place and hold it up on upright position by placing the suitable stand under the engine.
3. Check:
 - Transmission oil level



Transmission oil level checking steps:

- a. Remove the oil check bolt "1".
- b. Inspect the oil level.

TIP

Be sure the machine is positioned straight up when inspecting the oil level.

CHASSIS

BLEEDING THE HYDRAULIC BRAKE SYSTEM

⚠ WARNING

Bleed the brake system if:

- The system has been disassembled.
 - A brake hose has been loosened or removed.
 - A brake fluid is very low.
 - The brake operation is faulty.
- A dangerous loss of braking performance may occur if the brake system is not properly bled.

1. Remove:
 - Brake master cylinder cap
 - Diaphragm
 - Reservoir float (front brake)
 - Protector (rear brake)
2. Bleed:
 - Brake fluid



Air bleeding steps:

- a. Add proper brake fluid to the reservoir.
- b. Install the diaphragm. Be careful not to spill any fluid or allow the reservoir to overflow.
- c. Connect the clear plastic tube "2" tightly to the caliper bleed screw "1".

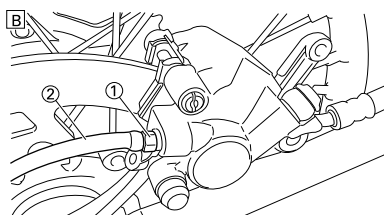
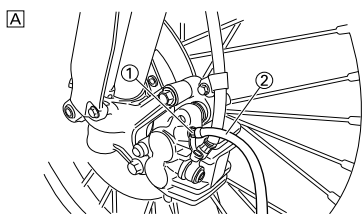

A. Front
B. Rear

- d. Place the other end of the tube into a container.
- e. Slowly apply the brake lever or pedal several times.
- f. Pull the lever in or push down on the pedal. Hold the lever or pedal in position.
- g. Loosen the bleed screw and allow the lever or pedal to travel towards its limit.

- h. Tighten the bleed screw when the lever or pedal limit has been reached; then release the lever or pedal.

	Bleed screw: 6 Nm (0.6 m•kg, 4.3 ft•lb)
---	---

- i. Repeat steps (e) to (h) until the air bubbles have been removed from the system.

TIP

If bleeding is difficult, it may be necessary to let the brake fluid system stabilize for a few hours. Repeat the bleeding procedure when the tiny bubbles in the system have disappeared.

- j. Add brake fluid to the level line on the reservoir.

⚠ WARNING

Check the operation of the brake after bleeding the brake system.



3. Install:
 - Protector (rear brake)
 - Reservoir float (front brake)
 - Diaphragm
 - Brake master cylinder cap

ADJUSTING THE FRONT BRAKE

1. Check:
 - Brake lever position "a"

	Brake lever position "a":	
	Standard position	Extent of adjustment
	95 mm (3.74 in)	86–105 mm (3.39–4.13 in)

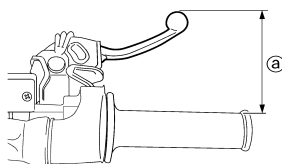

2. Remove:
 - Brake lever cover
3. Adjust:
 - Brake lever position



Brake lever position adjustment steps:

- a. Loosen the locknut "1".
- b. Turn the adjusting bolt "2" until the lever position "a" is within specified position.

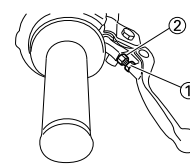

- c. Tighten the locknut.

	Locknut: 5 Nm (0.5 m•kg, 3.6 ft•lb)
---	---

⚠ WARNING

Be sure to tighten the locknut, as it will cause poor brake performance.



4. Install:
 - Brake lever cover

ADJUSTING THE REAR BRAKE

1. Check:
 - Brake pedal height "a"

Out of specification → Adjust.

	Brake pedal height "a": 0.0 mm (0.00 in)
--	--



2. Adjust:
 - Brake pedal height



Pedal height adjustment steps:

- a. Loosen the locknut "1".
- b. Turn the adjusting nut "2" until the pedal height "a" is within specified height.
- c. Tighten the locknut.

⚠ WARNING

- Adjust the pedal height between the maximum "A" and the minimum "B" as shown. (In this adjustment, the bolt "3" end "b" should protrude out of the threaded portion "4" but not be less than 2 mm (0.08 in) "c" away from the brake pedal "5").
- After the pedal height adjustment, make sure that the rear brake does not drag.

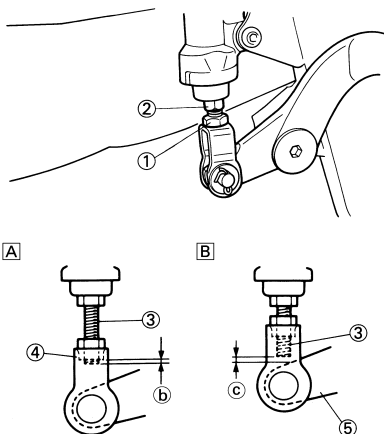

d. Remove the pad pin and brake pads "4".

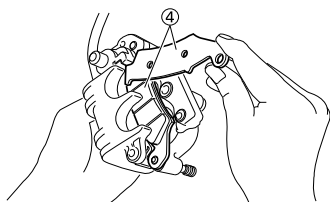

e. Connect the transparent hose "5" to the bleed screw "6" and place the suitable container under its end.

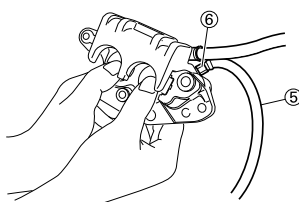

f. Loosen the bleed screw and push the brake caliper pistons in.

⚠ WARNING
Do not reuse the drained brake fluid.

g. Tighten the bleed screw.

🔧 Bleed screw:
6 Nm (0.6 m•kg, 4.3 ft•lb)

h. Install the brake pads "7" and pad pin.

TIP

- Install the brake pads with their projections "a" into the brake caliper recesses "b".
- Temporarily tighten the pad pin at this point.

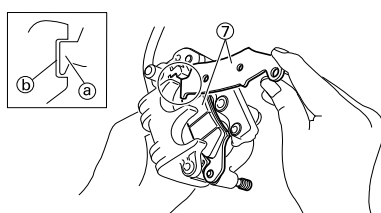

i. Install the brake caliper "8" and tighten the pad pin "9".

🔧 Bolt (brake caliper):
28 Nm (2.8 m•kg, 20 ft•lb)
Pad pin:
18 Nm (1.8 m•kg, 13 ft•lb)

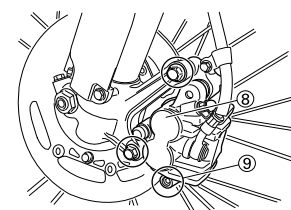

j. Install the pad pin plug "10".

🔧 Pad pin plug:
3 Nm (0.3 m•kg, 2.2 ft•lb)

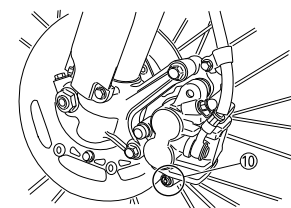

CHECKING AND REPLACING THE FRONT BRAKE PADS

1. Inspect:

- Brake pad thickness "a"
Out of specification → Replace as a set.

🔧 Brake pad thickness "a":
4.4 mm (0.17 in)
<Limit>: 1.0 mm (0.04 in)

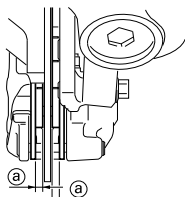

2. Replace:

- Brake pad

Brake pad replacement steps:

a. Remove the pad pin plug "1".

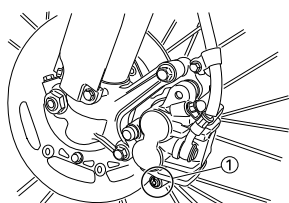

b. Loosen the pad pin "2".

c. Remove the brake caliper "3" from the front fork.

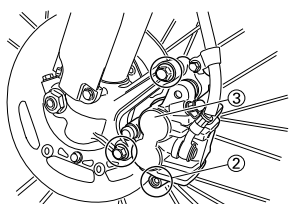

3. Inspect:

- Brake fluid level
Refer to "CHECKING THE BRAKE FLUID LEVEL" section.

4. Check:

- Brake lever operation
A softy or spongy feeling → Bleed brake system.
Refer to "BLEEDING THE HYDRAULIC BRAKE SYSTEM" section.

CHECKING AND REPLACING THE REAR BRAKE PADS

1. Inspect:

- Brake pad thickness "a"
Out of specification → Replace as a set.

🔧 Brake pad thickness "a":
6.4 mm (0.25 in)
<Limit>: 1.0 mm (0.04 in)

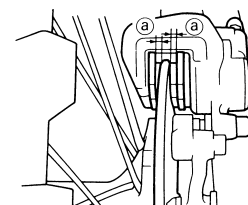

2. Replace:

- Brake pad

Brake pad replacement steps:

a. Remove the protector "1" and pad pin plug "2".

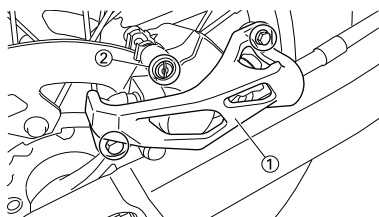

- b. Loosen the pad pin "3".
- c. Remove the rear wheel "4" and brake caliper "5".
Refer to "FRONT WHEEL AND REAR WHEEL" section in the CHAPTER 5.

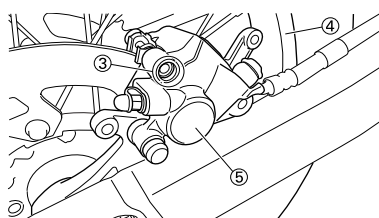

- d. Remove the pad pin "6" and brake pads "7".

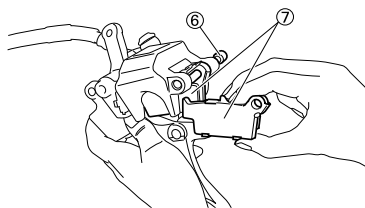

- e. Connect the transparent hose "8" to the bleed screw "9" and place the suitable container under its end.

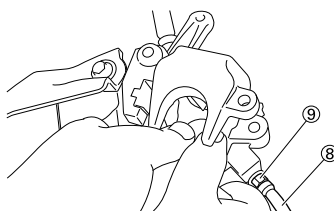

- f. Loosen the bleed screw and push the brake caliper piston in.

⚠ WARNING

Do not reuse the drained brake fluid.

- g. Tighten the bleed screw.



Bleed screw:
6 Nm (0.6 m•kg, 4.3 ft•lb)

- h. Install the brake pads "10" and pad pin "11".

TIP

- Install the brake pads with their projections "a" into the brake caliper recesses "b".
- Temporarily tighten the pad pin at this point.

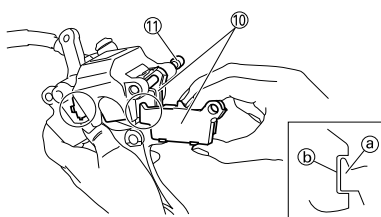

- i. Install the brake caliper "12" and rear wheel "13".
Refer to "FRONT WHEEL AND REAR WHEEL" section in the CHAPTER 5.
- j. Tighten the pad pin "14".

Pad pin:
18 Nm (1.8 m•kg, 13 ft•lb)

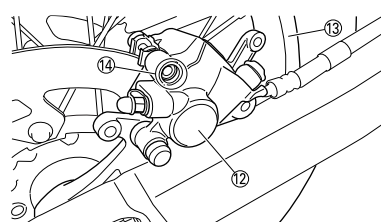

- k. Install the pad pin plug "15" and protector "16".

Pad pin plug:
3 Nm (0.3 m•kg, 2.2 ft•lb)
Bolt (protector):
7 Nm (0.7 m•kg, 5.1 ft•lb)

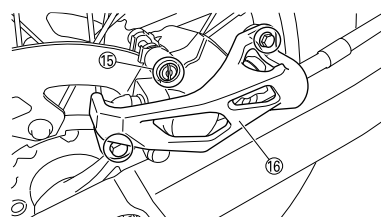

3. Inspect:
 - Brake fluid level
Refer to "CHECKING THE BRAKE FLUID LEVEL" section.
4. Check:
 - Brake pedal operation
A softy or spongy feeling → Bleed brake system.
Refer to "BLEEDING THE HYDRAULIC BRAKE SYSTEM" section.

CHECKING THE REAR BRAKE PAD INSULATOR

1. Remove:
 - Brake pad
Refer to "CHECKING AND REPLACING THE REAR BRAKE PADS" section.

2. Inspect:
 - Rear brake pad insulator "1"
Damage → Replace.

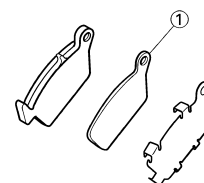

CHECKING THE BRAKE FLUID LEVEL

1. Place the brake master cylinder so that its top is in a horizontal position.
2. Inspect:
 - Brake fluid level
Fluid at lower level → Fill up.



Recommended brake fluid:
DOT #4

⚠ WARNING

- Use only designated quality brake fluid to avoid poor brake performance.
- Refill with same type and brand of brake fluid; mixing fluids could result in poor brake performance.
- Be sure that water or other contaminants do not enter master cylinder when refilling.
- Clean up spilled fluid immediately to avoid erosion of painted surfaces or plastic parts.

A

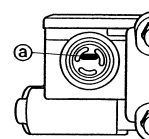

a. Lower level

A. Front

B. Rear

B

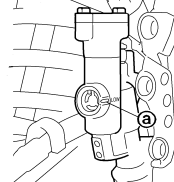

CHECKING THE SPROCKET

1. Inspect:
 - Sprocket teeth "a"
Excessive wear → Replace.

TIP

Replace the drive sprocket, rear wheel sprocket and drive chain as a set.

- d. Tighten the axle nut while pushing down the drive chain.

	Axle nut: 125 Nm (12.5 m•kg, 90 ft•lb)
---	---

- e. Tighten the locknuts.

	Locknut: 19 Nm (1.9 m•kg, 13 ft•lb)
---	--



CHECKING THE FRONT FORK

1. Inspect:
- Front fork smooth action
Operate the front brake and stroke the front fork.
Unsmooth action/oil leakage → Repair or replace.

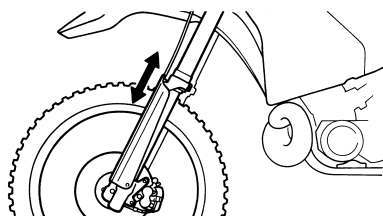

CHECKING THE FRONT FORK PROTECTOR GUIDE

1. Inspect:
- Protector guide "1"
Out of specification → Replace.

TIP
The protector guide reaches the limit of its use when it is worn down to the same height "a" as of the outer tube circumference.

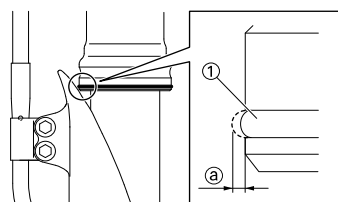

CLEANING THE FRONT FORK OIL SEAL AND DUST SEAL

1. Remove:
- Protector
 - Dust seal "1"

TIP
Use a thin screw driver, and be careful not to damage the inner fork tube and dust seal.

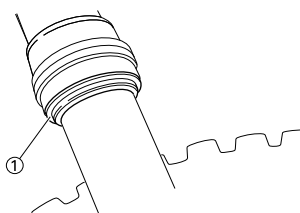

2. Clean:
- Dust seal "a"
 - Oil seal "b"

TIP
Clean the dust seal and oil seal after every run.
Apply the lithium soap base grease on the inner tube.

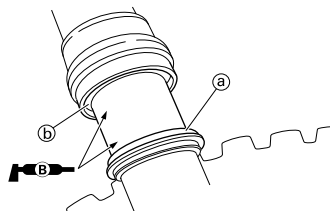

RELIEVING THE FRONT FORK INTERNAL PRESSURE

TIP
If the front fork initial movement feels stiff during a run, relieve the front fork internal pressure.

1. Elevate the front wheel by placing a suitable stand under the engine.
2. Remove the air bleed screw "1" and release the internal pressure from the front fork.
3. Install:
 - Air bleed screw

	Air bleed screw: 1 Nm (0.1 m•kg, 0.7 ft•lb)
---	--

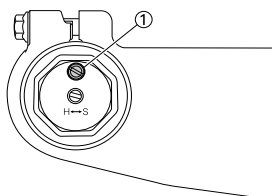

ADJUSTING THE FRONT FORK REBOUND DAMPING FORCE

1. Adjust:
- Rebound damping force
By turning the adjuster "1".

Stiffer "a" → Increase the rebound damping force. (Turn the adjuster "1" in.)
Softer "b" → Decrease the rebound damping force. (Turn the adjuster "1" out.)

	Extent of adjustment:	
	Maximum	Minimum
	Fully turned in position	20 clicks out (from maximum position)

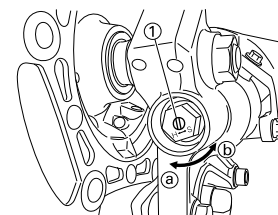

- **STANDARD POSITION:**
This is the position which is back by the specific number of clicks from the fully turned-in position.

	Standard position: 12 clicks out
---	---

NOTICE
Do not force the adjuster past the minimum or maximum extent of adjustment. The adjuster may be damaged.

WARNING
Always adjust each front fork to the same setting. Uneven adjustment can cause poor handling and loss of stability.

ADJUSTING THE FRONT FORK COMPRESSION DAMPING FORCE

1. Adjust:
- Compression damping force
By turning the adjuster "1".

Stiffer "a" → Increase the compression damping force. (Turn the adjuster "1" in.)
Softer "b" → Decrease the compression damping force. (Turn the adjuster "1" out.)

	Extent of adjustment:	
	Maximum	Minimum
	Fully turned in position	20 clicks out (from maximum position)

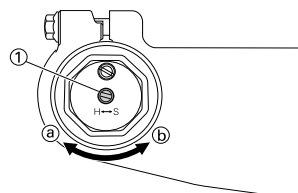

- **STANDARD POSITION:**
This is the position which is back by the specific number of clicks from the fully turned-in position.

	Standard position: 12 clicks out
---	---

NOTICE

Do not force the adjuster past the minimum or maximum extent of adjustment. The adjuster may be damaged.

WARNING

Always adjust each front fork to the same setting. Uneven adjustment can cause poor handling and loss of stability.

CHECKING THE REAR SHOCK ABSORBER

- Inspect:
 - Swingarm smooth action
Abnormal noise/unsmooth action → Grease the pivoting points or repair the pivoting points.
Damage/oil leakage → Replace.

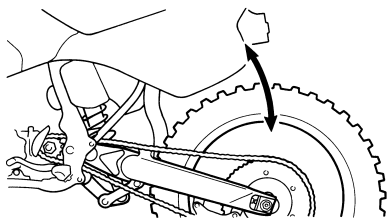

ADJUSTING THE REAR SHOCK ABSORBER SPRING PRELOAD

- Elevate the rear wheel by placing the suitable stand under the engine.
- Remove:
 - Rear frame
- Measure:
 - Spring fitting length

	Standard fitting length:	
I.D. MARK/ Q'TY	Length	
Black/1	248.0 mm (9.76 in)	

TIP

The I.D. mark "a" is marked at the end of the spring.





- Adjust:
 - Spring preload

Adjustment steps:

- Loosen the locknut "1".
- Loosen the adjuster "2" until there is some clearance between the spring and adjuster.
- Measure the spring free length "a".
- Turn the adjuster "2".

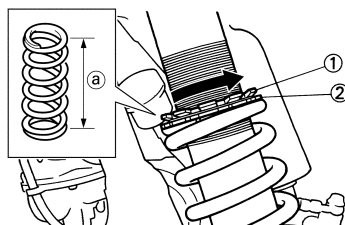
Stiffer → Increase the spring preload. (Turn the adjuster "2" in.)
Softer → Decrease the spring preload. (Turn the adjuster "2" out.)



	Extent of adjustment:	
Maximum	Minimum	
Position in which the spring is turned in 18 mm (0.71 in) from its free length	Position in which the spring is turned in 1.5 mm (0.06 in) from its free length	

TIP

- Be sure to remove all dirt and mud from around the locknut and adjuster before adjustment.
- The length of the spring (installed) changes 1.5 mm (0.06 in) per turn of the adjuster.

NOTICE

Never attempt to turn the adjuster beyond the maximum or minimum setting.

- Tighten the locknut.

	Locknut: 30 Nm (3.0 m•kg, 22 ft•lb)
---	--

- Install:
 - Rear frame (upper)

	Rear frame (upper): 32 Nm (3.2 m•kg, 23 ft•lb)
---	---

- Rear frame (lower)

	Rear frame (lower): 29 Nm (2.9 m•kg, 21 ft•lb)
---	---

ADJUSTING THE REAR SHOCK ABSORBER REBOUND DAMPING FORCE

- Adjust:
 - Rebound damping force
By turning the adjuster "1".

Stiffer "a" → Increase the rebound damping force. (Turn the adjuster "1" in.)
Softer "b" → Decrease the rebound damping force. (Turn the adjuster "1" out.)

	Extent of adjustment:	
Maximum	Minimum	
Fully turned in position	20 clicks out (from maximum position)	

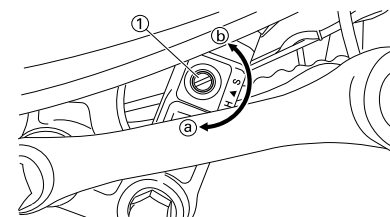

- STANDARD POSITION:**
This is the position which is back by the specific number of clicks from the fully turned-in position. (Which align the punch mark "a" on the adjuster with the punch mark "b" on the bracket.)

	Standard position: 9–12 clicks out
---	---

NOTICE

Do not force the adjuster past the minimum or maximum extent of adjustment. The adjuster may be damaged.

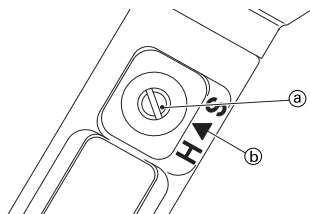

ADJUSTING THE REAR SHOCK ABSORBER LOW COMPRESSION DAMPING FORCE

- Adjust:
 - Low compression damping force
By turning the adjuster "1".

Stiffer "a" → Increase the low compression damping force. (Turn the adjuster "1" in.)
Softer "b" → Decrease the low compression damping force. (Turn the adjuster "1" out.)

Extent of adjustment:	
Maximum	Minimum
Fully turned in position	20 clicks out (from maximum position)

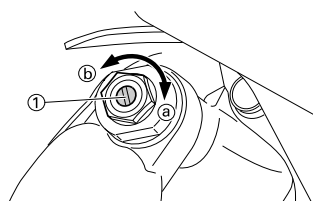

- STANDARD POSITION:**
This is the position which is back by the specific number of clicks from the fully turned-in position. (Which align the punch mark "a" on the adjuster with the punch mark "b" on the high compression damping adjuster.)

Standard position: 11–14 clicks out	
--	--

NOTICE

Do not force the adjuster past the minimum or maximum extent of adjustment. The adjuster may be damaged.

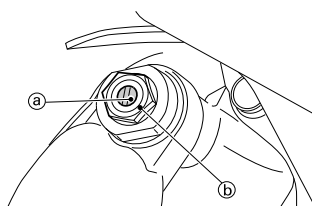

ADJUSTING THE REAR SHOCK ABSORBER HIGH COMPRESSION DAMPING FORCE

- Adjust:
 - High compression damping force
By turning the adjuster "1".

Stiffer "a" → Increase the high compression damping force. (Turn the adjuster "1" in.)
Softer "b" → Decrease the high compression damping force. (Turn the adjuster "1" out.)

Extent of adjustment:	
Maximum	Minimum
Fully turned in position	2 turns out (from maximum position)

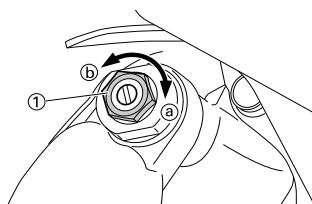

- STANDARD POSITION:**
This is the position which is back by the specific number of turns from the fully turned-in position. (Which align the punch mark "a" on the adjuster with the punch mark "b" on the adjuster body.)

Standard position: 1-3/8±1/6 turns out	
---	--

NOTICE

Do not force the adjuster past the minimum or maximum extent of adjustment. The adjuster may be damaged.

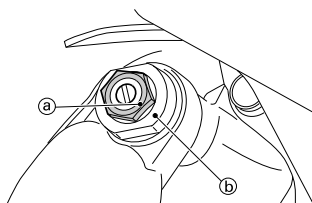

CHECKING THE TIRE PRESSURE

- Measure:
 - Tire pressure
Out of specification → Adjust.

	Standard tire pressure: 100 kPa (1.00 kgf/cm ² , 15 psi)
--	---

TIP

- Check the tire while it is cold.
- Loose bead stoppers allow the tire to slip off its position on the rim when the tire pressure is low.
- A tilted tire valve stem indicates that the tire slips off its position on the rim.
- If the tire valve stem is found tilted, the tire is considered to be slipping off its position. Correct the tire position.

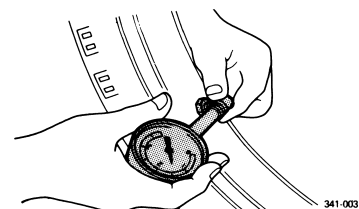

CHECKING AND TIGHTENING THE SPOKES

The following procedure applies to all of the spokes.

- Check:
 - Spoke
Bend/damage → Replace.
Loose spoke → Retighten.
Tap the spokes with a screwdriver.

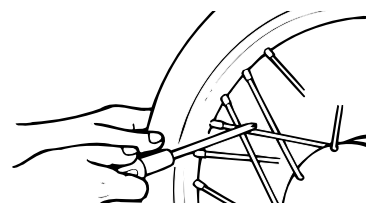

TIP

A tight spoke will emit a clear, ringing tone; a loose spoke will sound flat.

- Tighten:
 - Spoke
(with a spoke nipple wrench "1")

TIP

Be sure to tighten the spokes before and after break-in.

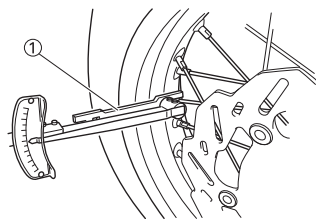

Spoke nipple wrench:
YM-01521/90890-01521

Spoke:
3 Nm (0.3 m•kg, 2.2 ft•lb)

CHECKING THE WHEELS

1. Inspect:

- Wheel runout
Elevate the wheel and turn it.
Abnormal runout → Replace.

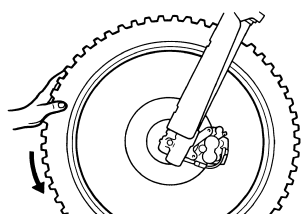

2. Inspect:

- Bearing free play
Exist play → Replace.

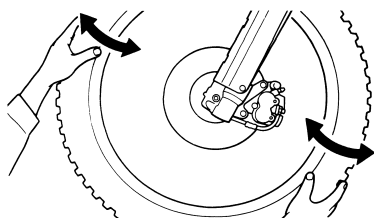

CHECKING AND ADJUSTING THE STEERING HEAD

1. Place a stand under the engine to raise the front wheel off the ground. **WARNING! Securely support the vehicle so that there is no danger of it falling over.**

2. Check:

- Steering stem
Grasp the bottom of the forks and gently rock the fork assembly back and forth.
Free play → Adjust steering head.

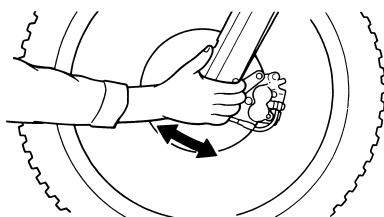

3. Check:

- Steering smooth action
Turn the handlebar lock to lock.
Unsmooth action → Adjust steering ring nut.

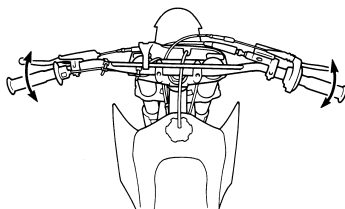

4. Adjust:

- Steering ring nut



Steering ring nut adjustment steps:

- Remove the number plate.
- Remove the handlebar and upper bracket.
- Loosen the steering ring nut "1" using the steering nut wrench "2".

Steering nut wrench:
YU-A9472/90890-01403

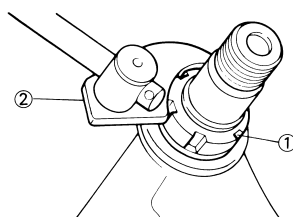

d. Tighten the steering ring nut "3" using steering nut wrench "4".

TIP

- Apply the lithium soap base grease on the thread of the steering stem.
- Set the torque wrench to the steering nut wrench so that they form a right angle.

Steering nut wrench:
YU-A9472/90890-01403

Steering ring nut (initial tightening):
38 Nm (3.8 m•kg, 27 ft•lb)

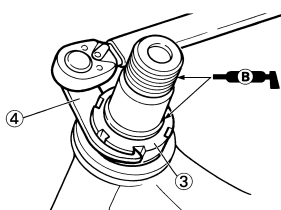

e. Loosen the steering ring nut one turn.

f. Retighten the steering ring nut using the steering nut wrench.

⚠ WARNING

Avoid over-tightening.

Steering ring nut (final tightening):
7 Nm (0.7 m•kg, 5.1 ft•lb)

g. Check the M stem by turning it lock to lock. If there is any binding, remove the steering stem assembly and inspect the steering bearings.

h. Install the washer "5", upper bracket "6", washer "7", steering stem nut "8", handlebar "9", handlebar upper holders "10" and number plate "11".

TIP

- The handlebar upper holder should be installed with the punched mark "a" forward.
- Install the handlebar so that the marks "b" are in place on both sides.
- Install the handlebar so that the projection "c" of the handlebar upper holder is positioned at the mark on the handlebar as shown.
- Insert the end of the fuel breather hose "12" into the hole in the steering stem.

NOTICE

First tighten the bolts on the front side of the handlebar upper holder, and then tighten the bolts on the rear side.

Steering stem nut:
145 Nm (14.5 m•kg, 105 ft•lb)
Handlebar upper holder:
28 Nm (2.8 m•kg, 20 ft•lb)
Pinch bolt (upper bracket):
21 Nm (2.1 m•kg, 15 ft•lb)
Number plate:
7 Nm (0.7 m•kg, 5.1 ft•lb)

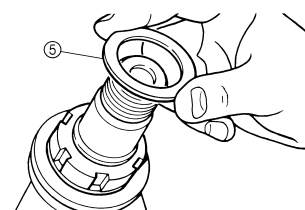

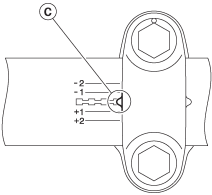
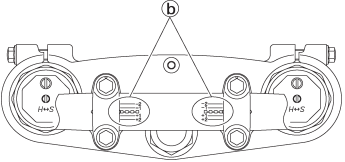
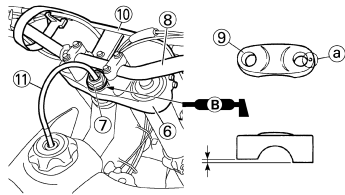

LUBRICATION

A

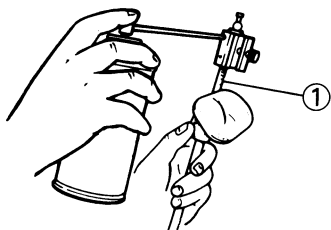

A

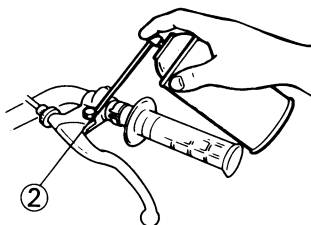

A

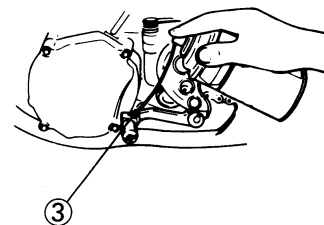

A

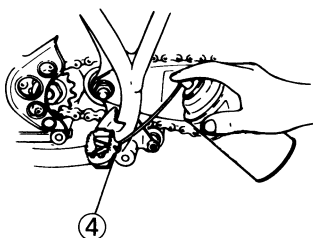

A

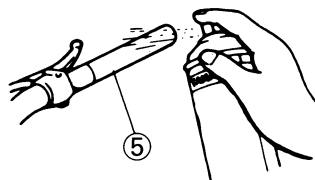

B

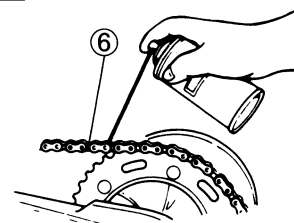

C

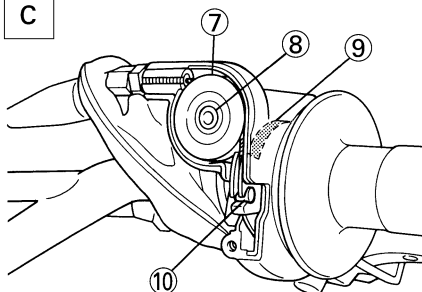

C

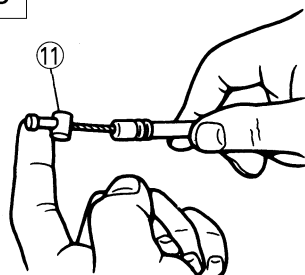

To ensure smooth operation of all components, lubricate your machine during setup, after break-in, and after every race.

1. All control cable
2. Clutch lever pivot
3. Shift pedal pivot
4. Footrest pivot
5. Throttle-to-handlebar contact
6. Drive chain
7. Throttle roller cable guide
8. Throttle roller sliding surface
9. Tube guide cable winding portion
10. Throttle cable end
11. Clutch cable end

- A. Use Yamaha cable lube or equivalent on these areas.
- B. Use SAE 10W-40 motor oil or suitable chain lubricants.
- C. Lubricate the following areas with high quality, lightweight lithium-soap base grease.

⚠ WARNING

Wipe off any excess grease, and avoid getting grease on the brake discs.

ELECTRICAL

CHECKING THE SPARK PLUG

- Remove:
 - Spark plug
- Inspect:
 - Electrode "1"
 - Wear/damage → Replace.
 - Insulator color "2"
 - Normal condition is a medium to light tan color.
 - Distinctly different color → Check the engine condition.

TIP

When the engine runs for many hours at low speeds, the spark plug insulator will become sooty, even if the engine and carburetor are in good operating condition.

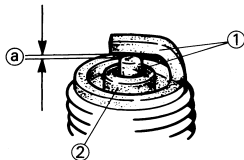

- Measure:
 - Plug gap "a"
 - Use a wire gauge or thickness gauge.
 - Out of specification → Regap.

	Spark plug gap "a": 0.5–0.6 mm (0.020–0.024 in)
---	---

Standard spark plug: BR8EG/NGK (resistance type)	
--	--

- Clean the plug with a spark plug cleaner if necessary.
- Tighten:
 - Spark plug

	Spark plug: 20 Nm (2.0 m•kg, 14 ft•lb)
---	--

TIP

- Before installing a spark plug, clean the gasket surface and plug surface.
- Finger-tighten "a" the spark plug before torquing to specification "b".

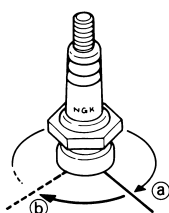

377-004

CHECKING THE IGNITION TIMING

- Remove:
 - Fuel tank
Refer to "SEAT, FUEL TANK AND SIDE COVERS" section in the CHAPTER 4.
 - Spark plug
 - Crankcase cover (left)
- Attach:
 - Dial gauge "1"
 - Spark plug hole dial stand "2"

	Dial gauge: YU-03097-B/90890-01252
	Spark plug hole dial stand: YU-01256

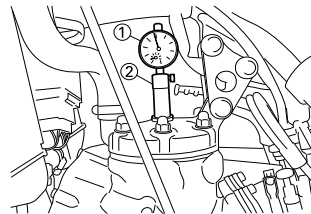

- Rotate the magneto rotor "1" until the piston reaches top dead center (TDC). When this happens, the needle on the dial gauge will stop and reverse directions even though the rotor is being turned in the same direction.

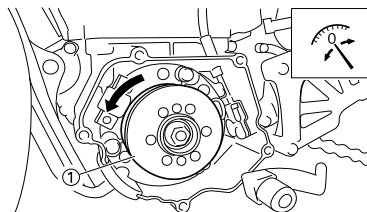

- Set the dial gauge to zero at TDC.
- From TDC, rotate the rotor clockwise until the dial gauge indicates that the piston is at a specified distance from TDC.

	Ignition timing (B.T.D.C.): 0.18 mm (0.007 in)
---	--

- Check:
 - Ignition timing
Punch mark "a" on rotor should be aligned with punch mark "b" on stator.
Not aligned → Adjust.

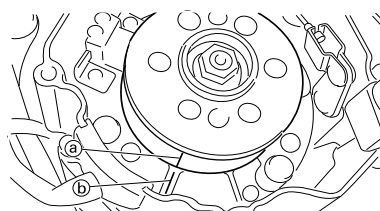

- Adjust:
 - Ignition timing



Adjustment steps:

- Loosen the screws (stator) "1".
- Align the punch mark on the rotor with punch mark on the stator "2" by moving the stator.
- Tighten the screws (stator).

	Screw (stator): 7 Nm (0.7 m•kg, 5.1 ft•lb)
---	--

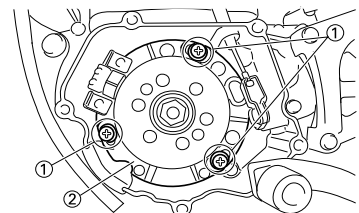

SEAT, FUEL TANK AND SIDE COVERS

ENGINE

TIP

This section is intended for those who have basic knowledge and skill concerning the servicing of Yamaha motorcycles (e.g., Yamaha dealers, service engineers, etc.). Those who have little knowledge and skill concerning servicing are requested not to undertake inspection, adjustment, disassembly, or reassembly only by reference to this manual. It may lead to servicing trouble and mechanical damage.

SEAT, FUEL TANK AND SIDE COVERS

REMOVING THE SEAT, FUEL TANK AND SIDE COVERS

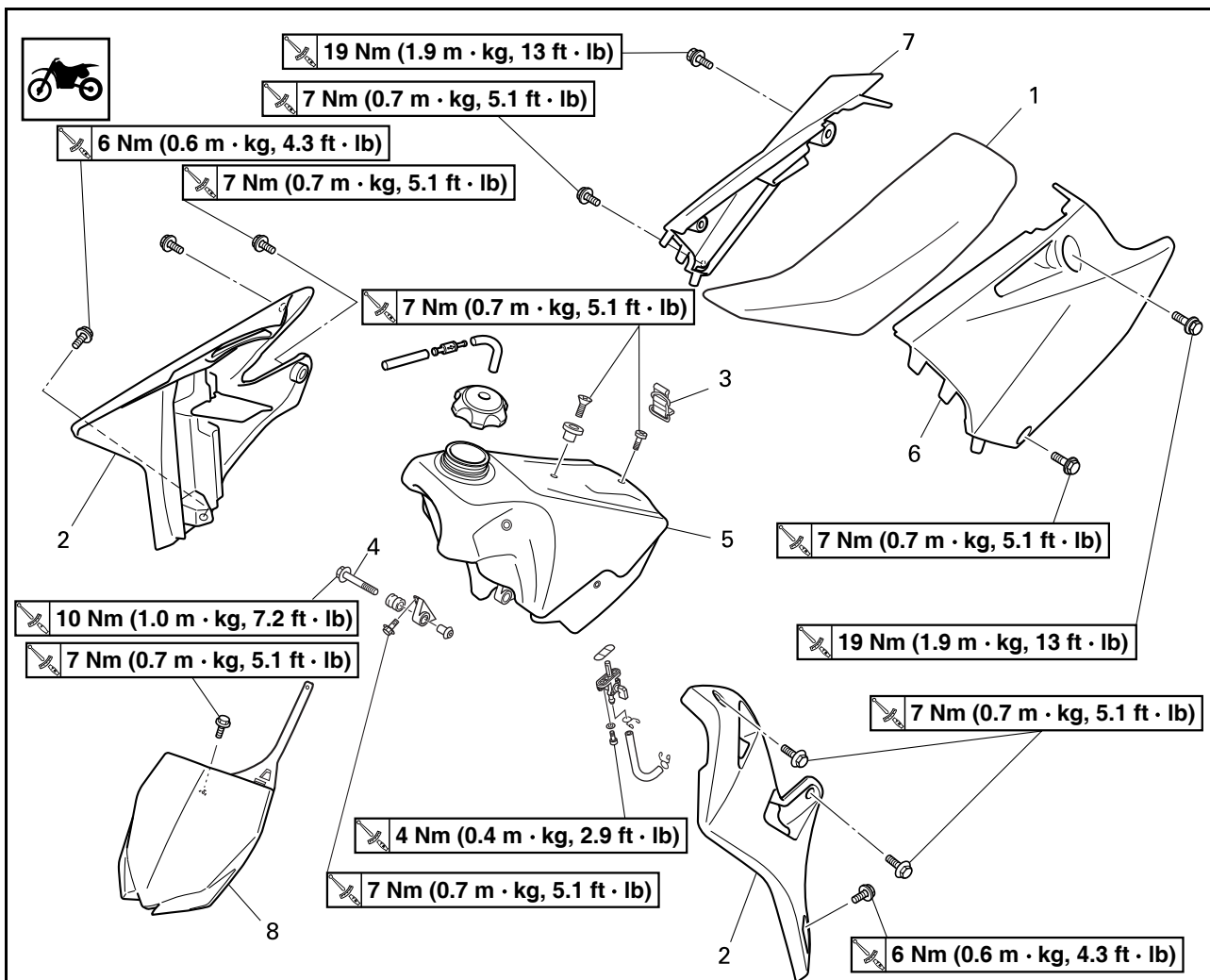

Order	Part name	Q'ty	Remarks
	Turn the fuel cock to "OFF".		
	Disconnect the fuel hose.		
1	Seat	1	
2	Air scoop (left and right)	2	
3	Fitting band	1	Remove on fuel tank side.
4	Bolt (fuel tank)	2	
5	Fuel tank	1	
6	Left side cover	1	Refer to removal section.
7	Right side cover	1	Refer to removal section.
8	Number plate	1	Refer to removal section.

SEAT, FUEL TANK AND SIDE COVERS

REMOVING THE SIDE COVER

1. Remove:
 - Bolt (side cover)
 - Side cover (left and right) "1"

TIP

Draw the side cover backward to remove it because its claws "a" are inserted in the air filter case.

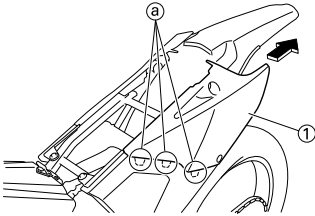

REMOVING THE NUMBER PLATE

1. Remove:
 - Bolt (number plate)
 - Number plate "1"

TIP

- The projection "a" is inserted into the band of the number plate. Pull the band off the projection before removal.
 - Remove the clutch cable "2" from the cable guide "b" on the number plate.
 - The projection "c" on the lower bracket is inserted into the number plate. Remove the number plate by pulling it off the projection.
-

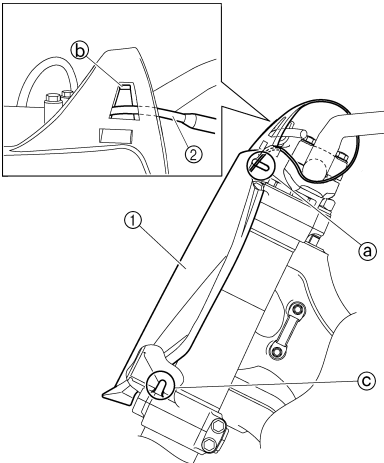

EXHAUST PIPE AND SILENCER

EXHAUST PIPE AND SILENCER

REMOVING THE EXHAUST PIPE AND SILENCER

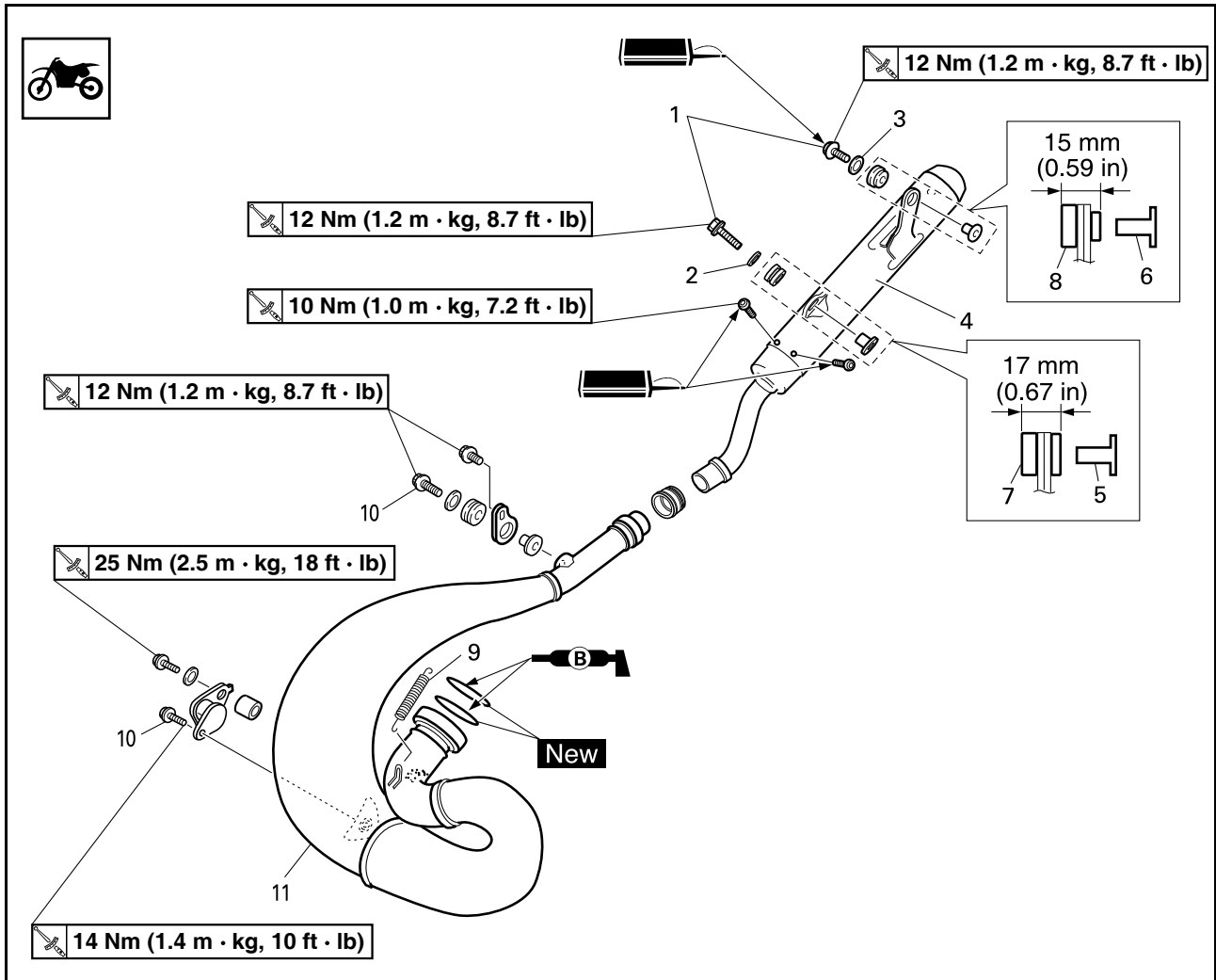

Order	Part name	Q'ty	Remarks
	Right side cover		Refer to "SEAT, FUEL TANK AND SIDE COVERS" section.
1	Bolt (silencer)	2	
2	Washer [ø=26 mm (1.02 in)]	1	
3	Washer [ø=22 mm (0.87 in)]	1	
4	Silencer	1	
5	Collar [L=15.5 mm (0.61 in)]	1	
6	Collar [L=13.5 mm (0.53 in)]	1	
7	Grommet (front)	1	
8	Grommet (rear)	1	
9	Tension spring	2	
10	Bolt (exhaust pipe)	2	
11	Exhaust pipe	1	

EXHAUST PIPE AND SILENCER

CHANGING THE SILENCER FIBER

- Remove:
 - Side cover (right)
 - Bolt (silencer) "1"
 - Silencer "2"
 - Bolt (fiber) "3"

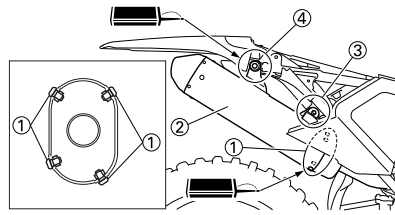
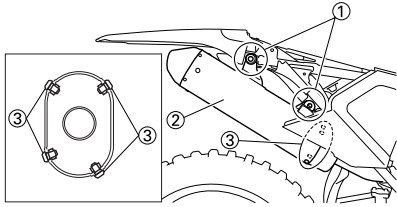

- Remove:
 - Inner pipe "1"
- Replace:
 - Fiber "2"

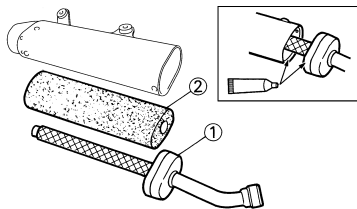

- Install:
 - Inner pipe

TIP

Fully apply Quick gasket® (Yamaha bond No.1215) or equivalent as shown.



Yamaha bond No.1215:
90890-85505
(Three bond No.1215®)

- Install:
 - Bolt (fiber) "1"



Bolt (fiber):
10 Nm (1.0 m•kg, 7.2
ft•lb)

- Silencer "2"
- Bolt [silencer (front)] "3"



Bolt [silencer (front)]:
12 Nm (1.2 m•kg, 8.7
ft•lb)

- Bolt [silencer (rear)] "4"



Bolt [silencer (rear)]:
12 Nm (1.2 m•kg, 8.7
ft•lb)

- Side cover (right)



Side cover (right):
7 Nm (0.7 m•kg, 5.1
ft•lb)

RADIATOR

REMOVING THE RADIATOR

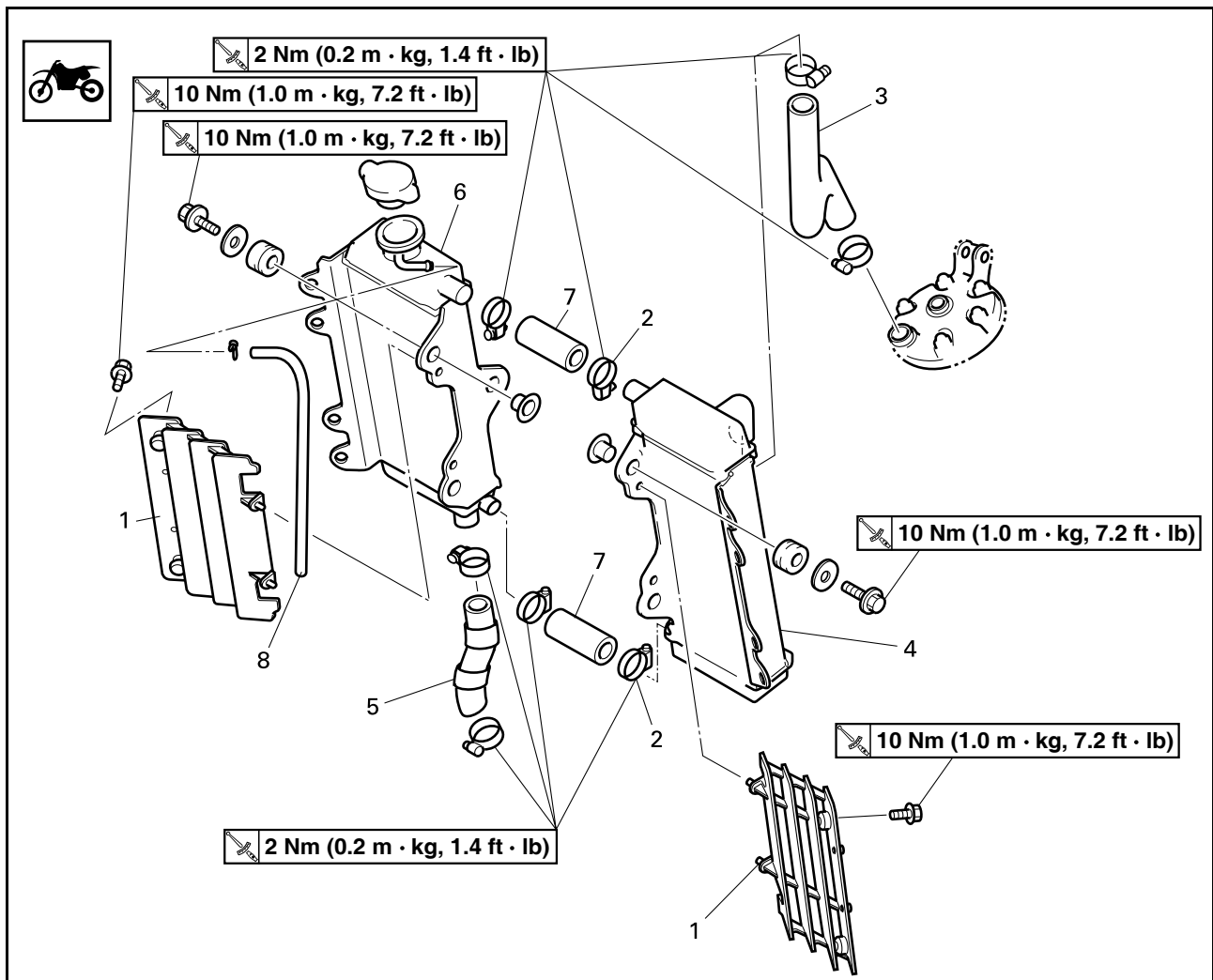

Order	Part name	Q'ty	Remarks
	Drain the coolant.		Refer to "CHANGING THE COOLANT" section in the CHAPTER 3.
	Seat and fuel tank		Refer to "SEAT, FUEL TANK AND SIDE COVERS" section.
1	Radiator guard	2	
2	Radiator hose clamp (radiator hose 2)	2	Only loosening.
3	Radiator hose 1	1	
4	Left radiator	1	
5	Radiator hose 4	1	
6	Right radiator	1	
7	Radiator hose 2	2	
8	Radiator breather hose	1	

HANDLING NOTE

⚠ WARNING

Do not remove the radiator cap when the engine and radiator are hot. Scalding hot fluid and steam may be blown out under pressure, which could cause serious injury. When the engine has cooled, open the radiator cap by the following procedure:
Place a thick rag, like a towel, over the radiator cap, slowly rotate the cap counterclockwise to the detent. This procedure allows any residual pressure to escape. When the hissing sound has stopped, press down on the cap while turning counterclockwise and remove it.

CHECKING THE RADIATOR

- Inspect:
 - Radiator core "1"
Obstruction → Blow out with compressed air through rear of the radiator.
 - Bent fin → Repair/replace.

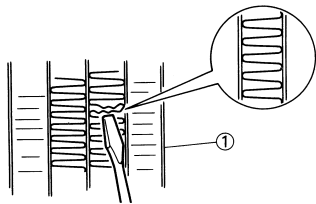

INSTALLING THE RADIATOR

- Install:
 - Radiator breather hose "1"
 - Radiator hose 2 "2"

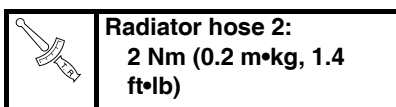

To right radiator "3".

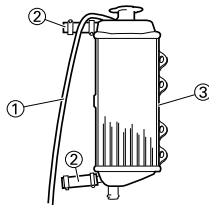

- Install:
 - Right radiator "1"
 - Washer "2"
 - Bolt (right radiator) "3"

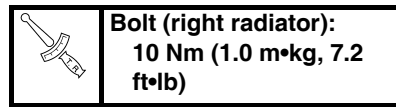

- Radiator hose 4 "4"

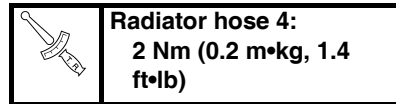

Refer to "CABLE ROUTING DIAGRAM" section in the CHAPTER 2.

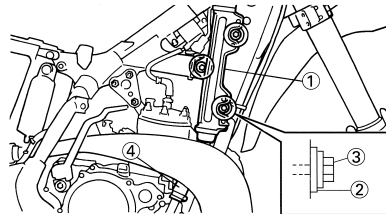

- Install:
 - Left radiator "1"
 - Washer "2"
 - Bolt (left radiator) "3"

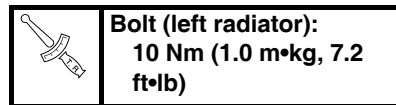

- Radiator hose 1 "4"

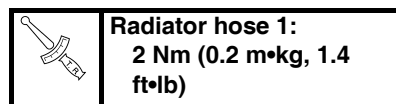

Refer to "CABLE ROUTING DIAGRAM" section in the CHAPTER 2.

- Tighten:
 - Radiator hose clamp 2 "5"

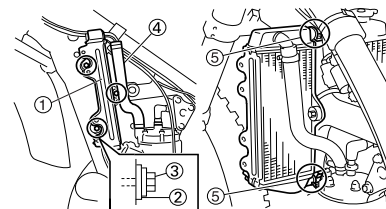
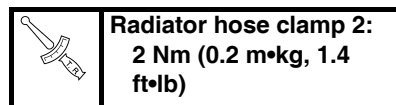

- Install:
 - Radiator guard "1"
 - Bolt (radiator guard) "2"

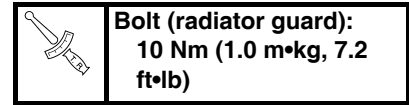

TIP

Fit the hook "a" on the inner side first into the radiator.

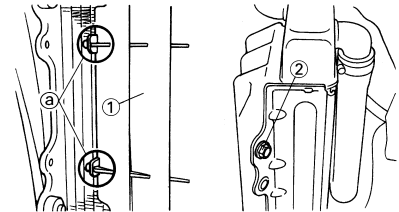

CARBURETOR AND REED VALVE

CARBURETOR AND REED VALVE REMOVING THE CARBURETOR AND REED VALVE

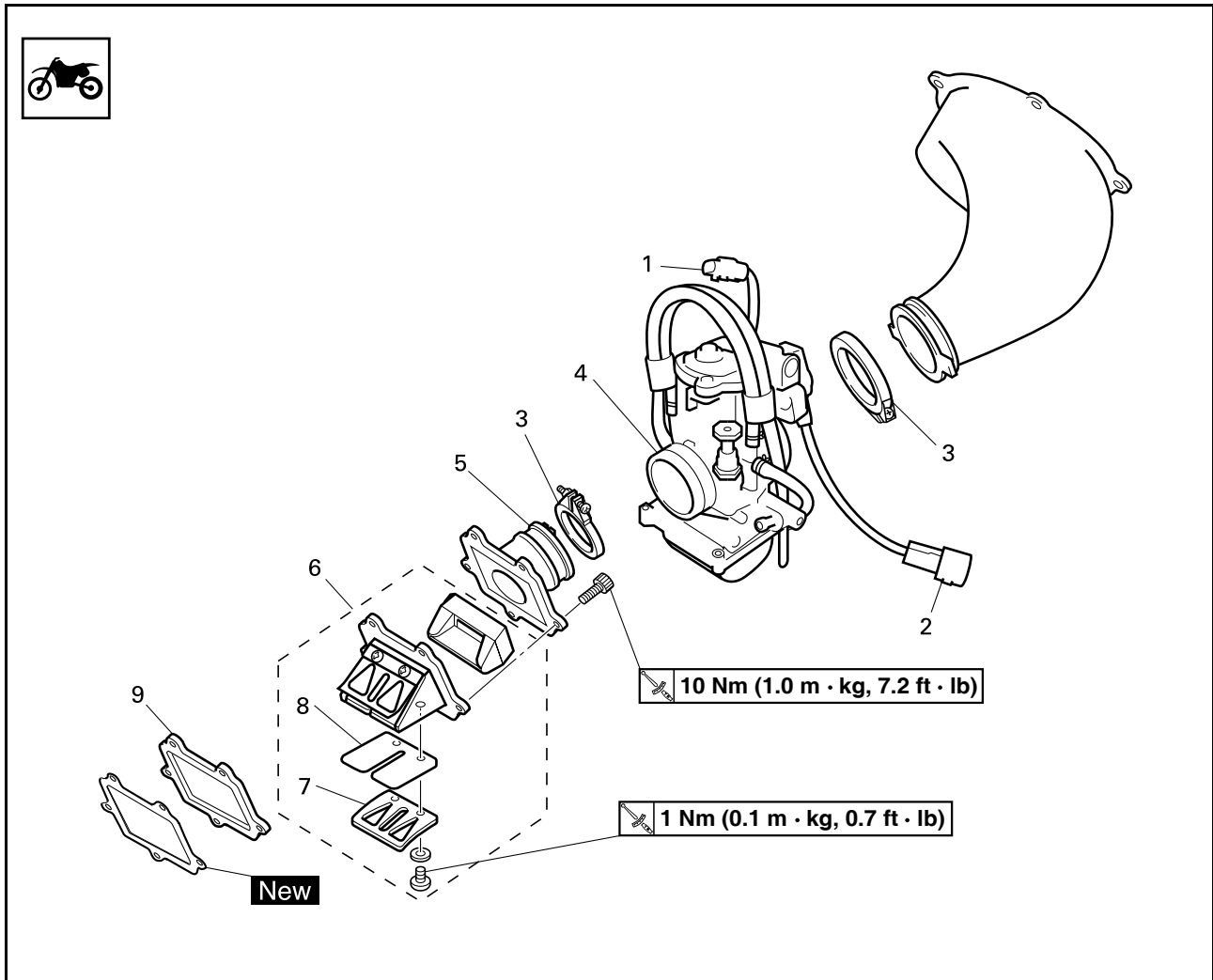

Order	Part name	Q'ty	Remarks
	Fuel tank		Refer to "SEAT, FUEL TANK AND SIDE COVERS" section.
1	Solenoid valve lead	1	Disconnect the solenoid valve lead.
2	Throttle position sensor lead	1	Disconnect the throttle position sensor lead.
3	Clamp (carburetor joint)	2	Loosen the screw (carburetor joint).
4	Carburetor	1	
5	Carburetor joint	1	
6	Reed valve assembly	1	
7	Stopper (reed valve)	2	
8	Reed valve	2	
9	Plate (reed valve)	1	

CARBURETOR AND REED VALVE

DISASSEMBLING THE CARBURETOR

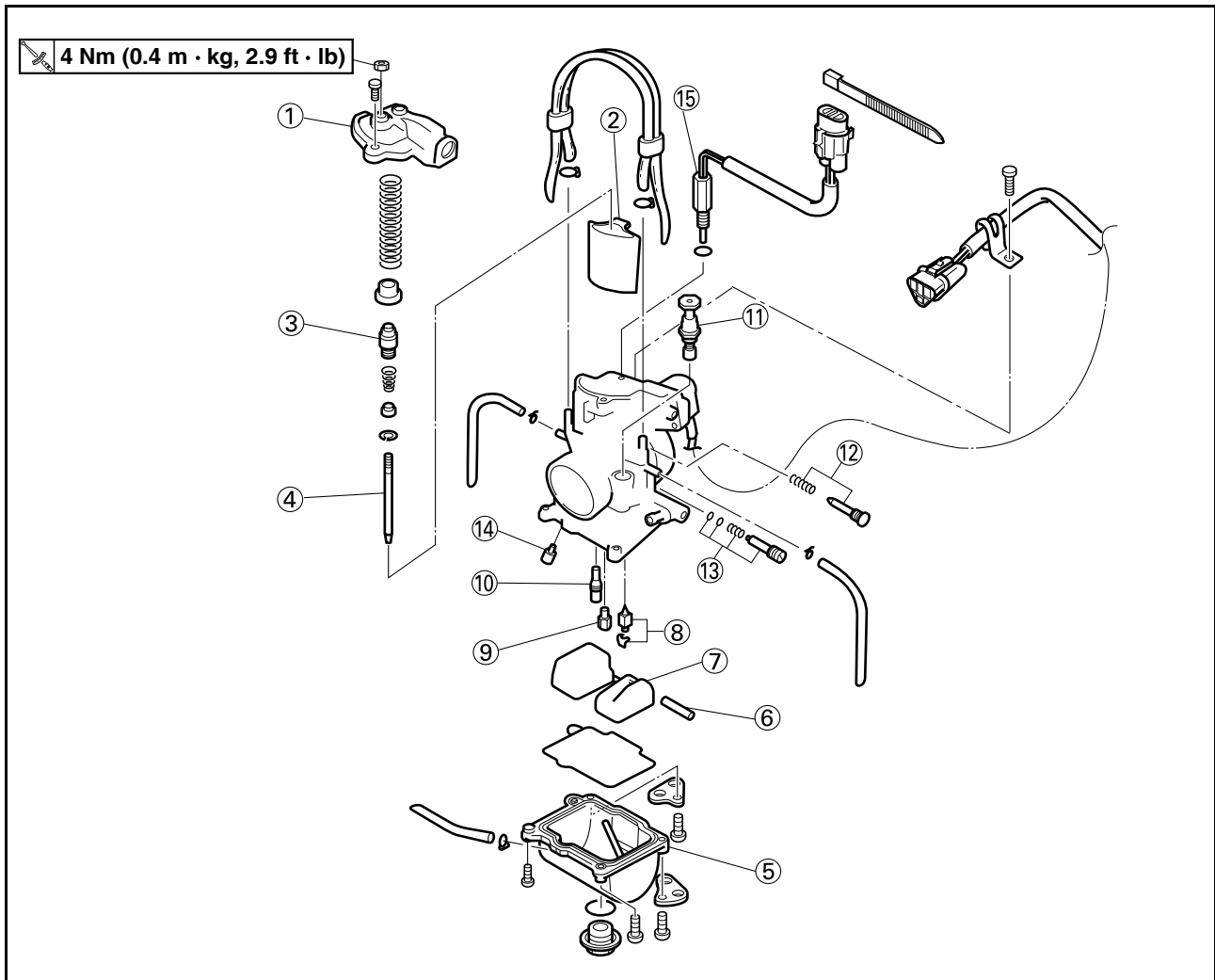

Order	Part name	Q'ty	Remarks
1	Mixing chamber top	1	
2	Throttle valve	1	Refer to removal section.
3	Needle holder	1	
4	Jet needle	1	
5	Float chamber	1	
6	Float pin	1	
7	Float	1	
8	Needle valve	1	
9	Main jet	1	
10	Pilot jet	1	
11	Starter plunger	1	
12	Throttle stop screw	1	
13	Pilot air screw	1	Refer to removal section.
14	Pilot jet	1	
15	Starter plunger	1	

CARBURETOR AND REED VALVE

HANDLING NOTE

NOTICE

Do not loosen the screw (throttle position sensor) "1" except when changing the throttle position sensor due to failure because it will cause a drop in engine performance.

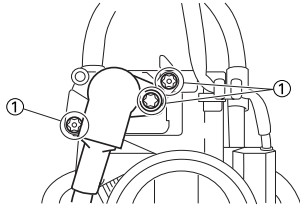

REMOVING THE THROTTLE VALVE

- Remove:
 - Throttle valve "1"
 - Ring "2"
 - Spring (throttle valve) "3"
 - Mixing chamber top "4"
 - Throttle cable "5"

TIP

While compressing the spring (throttle valve), disconnect the throttle cable.

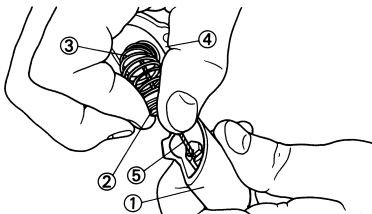

REMOVING THE PILOT AIR SCREW

- Remove:
 - Pilot air screw "1"

TIP

To optimize the fuel flow at a smaller throttle opening, each machine's pilot air screw has been individually set at the factory. Before removing the pilot air screw, turn it in fully and count the number of turns. Record this number as the factory-set number of turns out.

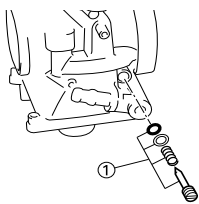

CHECKING THE CARBURETOR

- Inspect:
 - Carburetor body
Contamination → Clean.

TIP

- Use a petroleum based solvent for cleaning. Blow out all passages and jets with compressed air.
- Never use a wire.

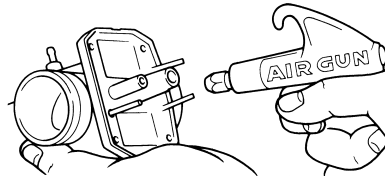

- Inspect:
 - Main jet "1"
 - Pilot jet "2"
 - Power jet "3"
 Contamination → Clean.

TIP

- Use a petroleum based solvent for cleaning. Blow out all passages and jets with compressed air.
- Never use a wire.

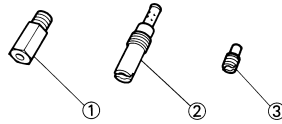

CHECKING THE NEEDLE VALVE

- Inspect:
 - Needle valve "1"
 - Valve seat "2"
 Grooved wear "a" → Replace.
Dust "b" → Clean.

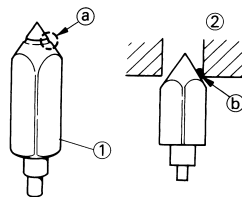

CHECKING THE THROTTLE VALVE

- Check:
 - Free movement
Stick → Repair or replace.

TIP

Insert the throttle valve "2" into the carburetor body while pulling up the lever "1", and check for free movement.

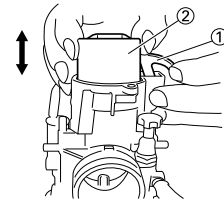

CHECKING THE JET NEEDLE

- Inspect:
 - Jet needle "1"
 - Bends/wear → Replace.
 - Clip groove
Free play exists/wear → Replace.
 - Clip position



* Except for USA and CDN

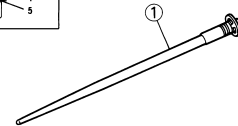
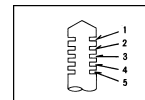

MEASURING AND ADJUSTING THE FLOAT HEIGHT

- Measure:
 - Float height "a"
 Out of specification → Adjust.

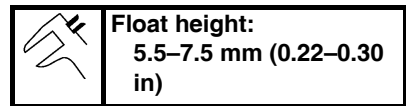

Measurement and adjustment steps:

- Hold the carburetor in an upside down position.
- Measure the distance between the mating surface of the float chamber and top of the float using a vernier calipers.

TIP

The float arm should be resting on the needle valve, but not compressing the needle valve.

- If the float height is not within specification, inspect the valve seat and needle valve.
- If either is worn, replace them both.
- If both are fine, adjust the float height by bending the float tab "b" on the float.
- Recheck the float height.

CARBURETOR AND REED VALVE



CHECKING THE FLOAT

- Inspect:
 - Float "1"
Damage → Replace.

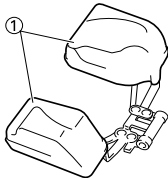

CHECKING THE REED VALVE

- Measure:
 - Reed valve bending "a"
Out of specification → Replace.

	Reed valve bending limit "a": 0.2 mm (0.01 in)
--	---

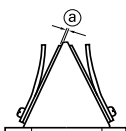

- Measure:
 - Valve stopper height "a"
Out of specification → Adjust stopper/Replace valve stopper.

	Valve stopper height "a": 10.3–10.7 mm (0.41–0.42 in)
--	--

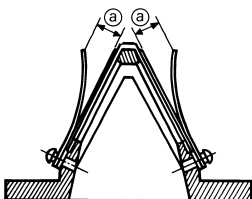

INSTALLING THE REED VALVE

- Install:
 - Reed valve "1"
 - Stopper (reed valve) "2"
 - Screw (reed valve) "3"

	Screw (reed valve): 1 Nm (0.1 m•kg, 0.7 ft•lb)
--	---

- TIP**
- Install the reed valve with the reed valve bending as shown.
 - Note the cut "a" in the lower corner of the reed and stopper plate.

- NOTICE**
- Tighten each screw gradually to avoid warping.

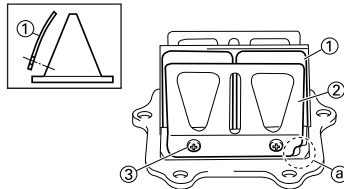

- Install:
 - Gasket (reed valve) "1" **New**
 - Plate (reed valve) "2"
 - Reed valve assembly "3"
 - Reed valve spacer "4"

- TIP**
- Install the reed valve spacer with its chamfered side "a" to the right.

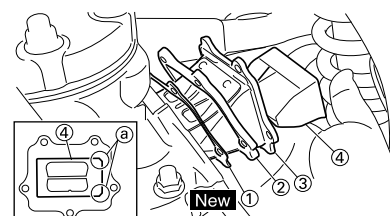

- Install:
 - Carburetor joint "1"
 - Bolt (carburetor joint) "2"

	Bolt (carburetor joint): 10 Nm (1.0 m•kg, 7.2 ft•lb)
--	---

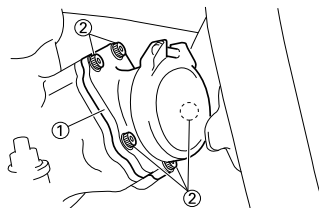

ASSEMBLING THE CARBURETOR

- Install:
 - Power jet "1"
To carburetor "2".

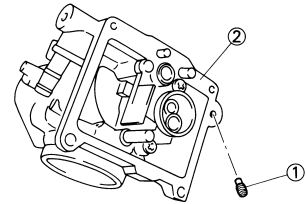

- Install:
 - O-ring "1"
 - Solenoid valve "2"
To carburetor.

- NOTICE**
- Before installing the solenoid valve, blow air on the solenoid valve and its installing location on the carburetor in order to remove any foreign particles such as chips etc.
 - Apply the engine oil on the solenoid valve thread.

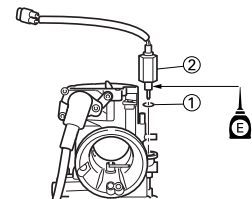

- Install:
 - Pilot air screw "1"
 - Throttle stop screw "2"

Note the following installation points:

- Turn in the pilot air screw until it is lightly seated.
- Turn out the pilot air screw by the number of turns recorded before removing.

	Pilot air screw: 1-1/4 turns out * 2-1/4 turns out (for reference only)
--	--

* Except for USA and CDN

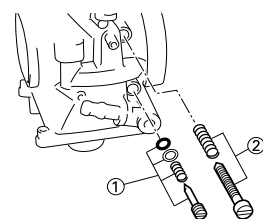

CARBURETOR AND REED VALVE

4. Install:

- Starter plunger "1"

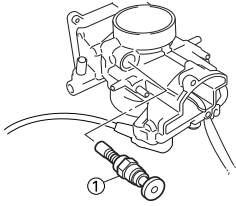

5. Install:

- Pilot jet "1"
- Main jet "2"

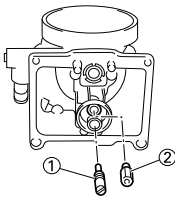

6. Install:

- Needle valve "1"
- Float "2"
- Float pin "3"

TIP

- After installing the needle valve to the float, install them to the carburetor.
- Check the float for smooth movement.

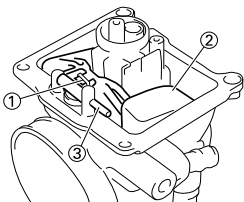

7. Install:

- Float chamber "1"
- Plate "2"
- Screw (float chamber) "3"

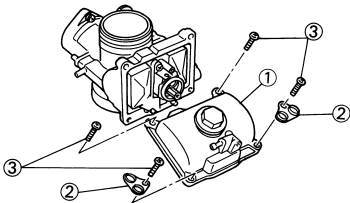

8. Install:

- Air vent hose [L=580 mm (22.8 in)] "1"
 - Air vent hose [L=400mm (15.7 in)] "2"
 - Overflow hose [L=280mm (11.0 in)] "3"
 - Clamp "4"
- Refer to "CABLE ROUTING DIAGRAM" section in the CHAPTER 2.

TIP

Install the air vent hoses and overflow hose to the carburetor with their ends not having the cuts "a" toward the carburetor.

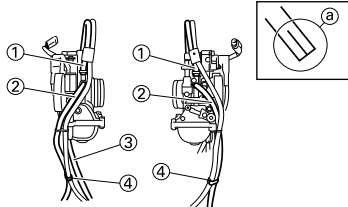

9. Install:

- Jet needle "1"
 - Collar "2"
 - Spring "3"
 - Needle holder "4"
- To throttle valve "5".

TIP

Install the spring with its smaller dia. "a" facing the collar.

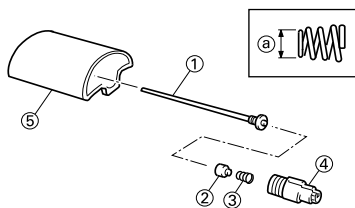

10. Install:

- Throttle cable "1"
- Locknut "2"



Locknut:
4 Nm (0.4 m•kg, 2.9 ft•lb)

- Mixing chamber top "3"
- Spring (throttle valve) "4"
- Ring "5"
- Throttle valve "6"

TIP

- While compressing the spring, connect the throttle cable.
- Align the projection "a" on the ring with the groove "b" in the needle holder "7".

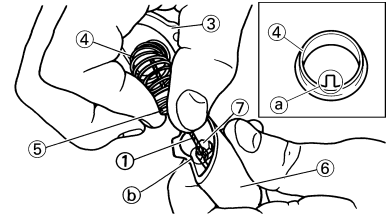
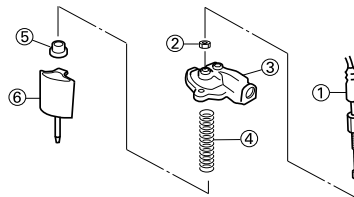

11. Install:

- Mixing chamber top "1"
 - Screw (mixing chamber top) "2"
- To carburetor "3".

TIP

- Insert the throttle valve into the carburetor body while pulling up the lever "4".
- After installing, check the throttle grip for smooth movement.

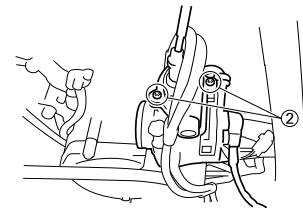
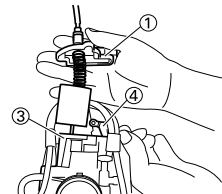

INSTALLING THE CARBURETOR

1. Install:

- Carburetor "1"

TIP

Install the projection between the carburetor joint slots.

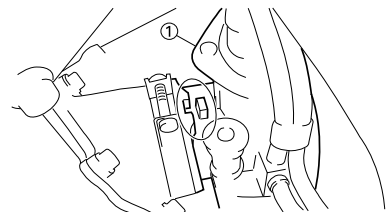

2. Tighten:

- Screw (carburetor joint) "1"

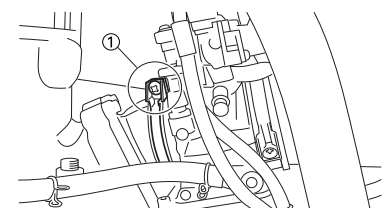

CARBURETOR AND REED VALVE

3. Tighten:

- Screw (air cleaner joint) "1"

TIP

Place the screw head "a" with its top as shown and secure the clamp in alignment with the horizontal line "b" that passes the center of the carburetor.

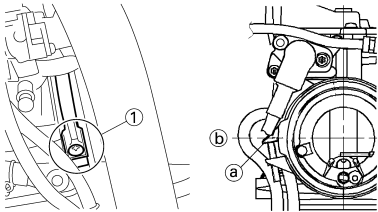

4. Connect:

- Throttle position sensor lead "1"
- Solenoid valve lead "2"

Refer to "CABLE ROUTING DIAGRAM" section in the CHAPTER 2.

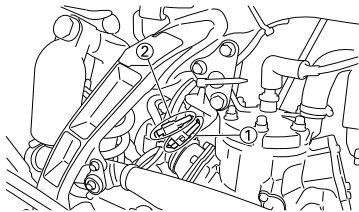

5. Adjust:

- Idle speed

Refer to "ADJUSTING THE ENGINE IDLING SPEED" section in the CHAPTER 3.

CYLINDER HEAD, CYLINDER AND PISTON

CYLINDER HEAD, CYLINDER AND PISTON REMOVING THE CYLINDER HEAD AND CYLINDER

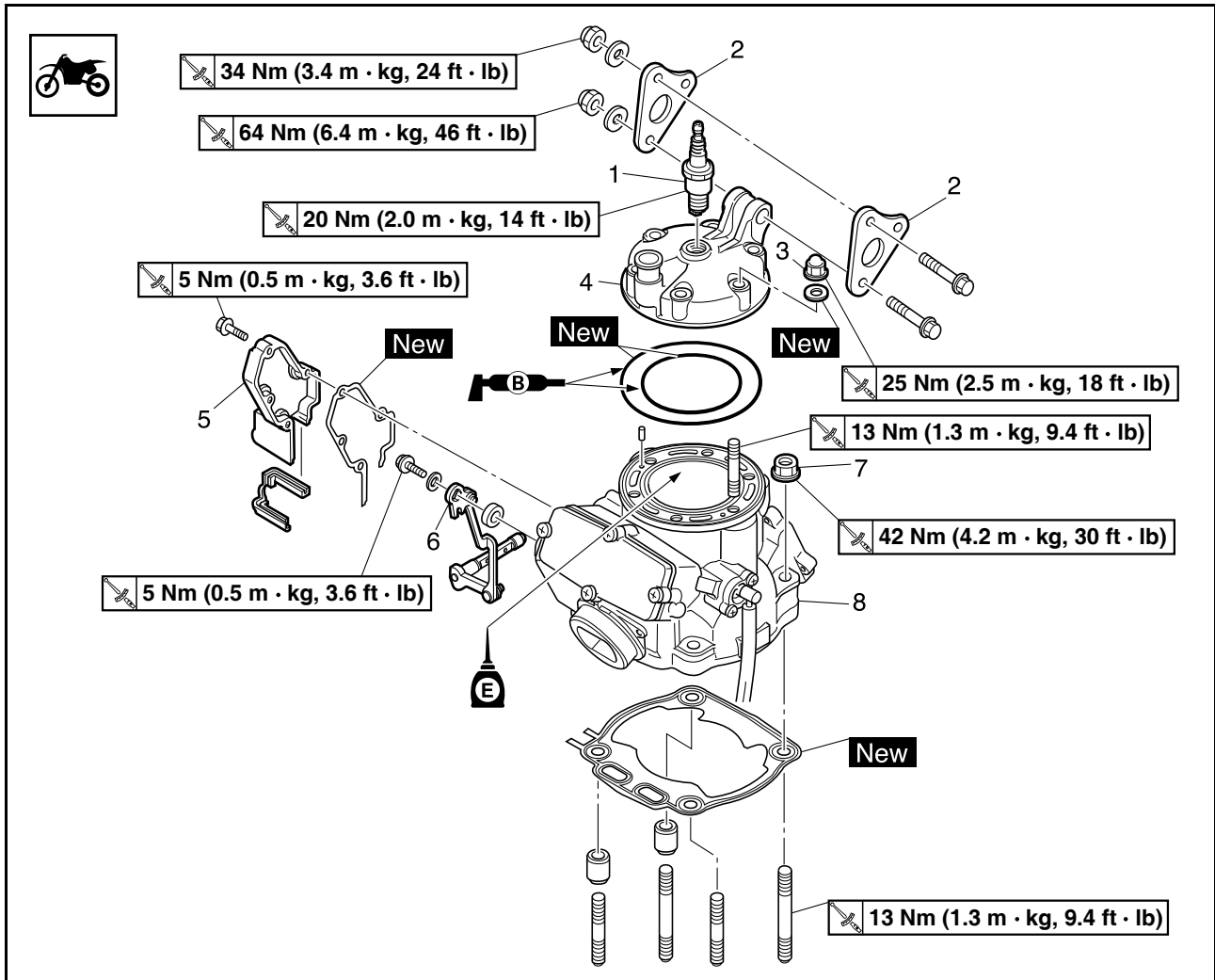

Order	Part name	Q'ty	Remarks
	Seat and fuel tank		Refer to "SEAT, FUEL TANK AND SIDE COVERS" section.
	Exhaust pipe and silencer		Refer to "EXHAUST PIPE AND SILENCER" section.
	Radiator hose 1		Disconnect at cylinder head side.
	Carburetor		Refer to "CARBURETOR AND REED VALVE" section.
1	Spark plug	1	
2	Engine bracket	2	
3	Nut (cylinder head)	6	Loosen each nut 1/4 turn, and remove them after all nuts are loosened.
4	Cylinder head	1	
5	Power valve housing	1	
6	Push rod	1	Refer to removal section.
7	Nut (cylinder)	4	
8	Cylinder	1	

CYLINDER HEAD, CYLINDER AND PISTON

REMOVING THE PISTON AND POWER VALVE

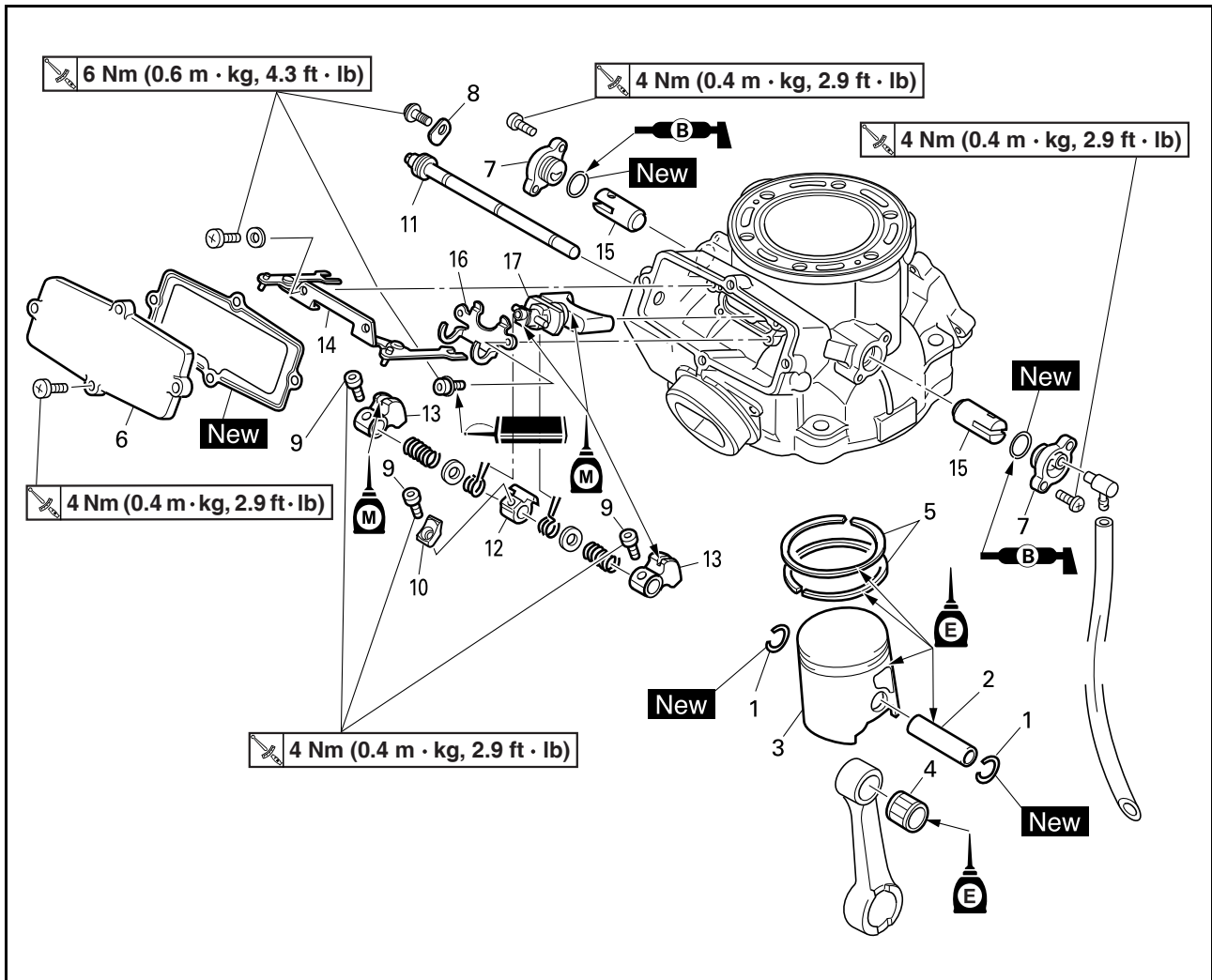

Order	Part name	Q'ty	Remarks
1	Piston pin clip	2	Refer to removal section.
2	Piston pin	1	Refer to removal section.
3	Piston	1	Refer to removal section.
4	Small end bearing	1	Refer to removal section.
5	Piston ring	2	Refer to removal section.
6	Power valve cover	1	
7	Side holder	2	
8	Thrust plate	1	
9	Bolt	3	
10	Valve holder 1	1	
11	Valve shaft	1	
12	Link lever	1	
13	Pulley	2	
14	Link rod	1	
15	Power valve 2	2	
16	Valve holder 2	1	
17	Power valve 1	1	

CYLINDER HEAD, CYLINDER AND PISTON

REMOVING THE PUSH ROD

- Remove:
 - Bolt (push rod) "1"
 - Push rod "2"

TIP
Insert the set pin "3" included in owner's tool kit to remove the bolt (push rod).

NOTICE

Be sure to use the set pin. If the set pin is not used, the power valve constituent parts will result in damage.

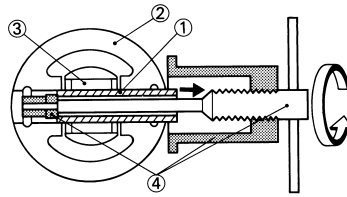
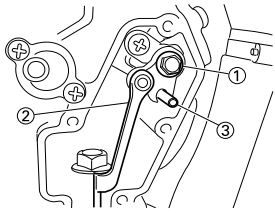

- Remove:
 - Piston ring "1"

TIP
Take care not to scratch the piston or damage the piston ring by expanding it more than necessary.

- Place a 400–600 grit wet sandpaper "3" on the surface plate, and resurface the head "4" using a figure-eight sanding pattern.

TIP
To ensure an even surface rotate the cylinder head several times.

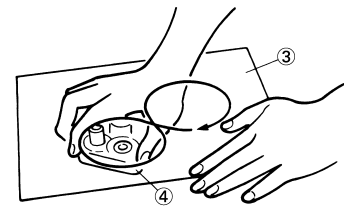
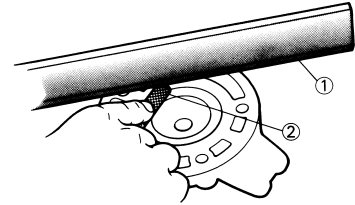

REMOVING THE PISTON AND PISTON RING

- Remove:
 - Piston pin clip "1"

TIP
Before removing the piston pin clip, cover the crankcase with a clean rag to prevent the piston pin clip from falling into the crankcase cavity.

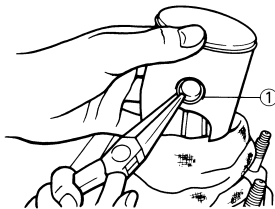

- Remove:
 - Piston pin "1"
 - Piston "2"
 - Small end bearing "3"

TIP
Before removing each piston pin, deburr the clip groove and pin hole area. If the piston pin groove is deburred and the piston pin is still difficult to remove, use the piston pin puller set "4".

	Piston pin puller set: YU-01304/90890-01304
---	--

NOTICE

Do not use a hammer to drive the piston pin out.

CHECKING THE CYLINDER HEAD

- Eliminate:
 - Carbon deposits
Use a rounded scraper "1".

TIP
Take care to avoid damaging the spark plug threads. Do not use a sharp instrument. Avoid scratching the aluminum.

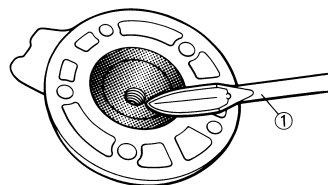
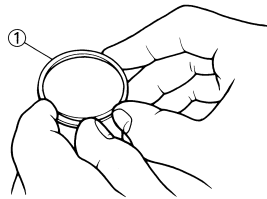

- Inspect:
 - Cylinder head water jacket
Crust of minerals/Rust → Replace.
- Measure:
 - Cylinder head warpage
Out of specification → Resurface.

	Cylinder head warpage: Less than 0.03 mm (0.0012 in)
---	---

Warpage measurement and resurfacing steps:

- Attach a straightedge "1" and a thickness gauge "2" on the cylinder head.
- Measure the warpage.
- If the warpage is out of specification, resurface the cylinder head.

CHECKING THE CYLINDER

- Eliminate:
 - Carbon deposits
Use a rounded scraper "1".

TIP
Do not use a sharp instrument. Avoid scratching the aluminum.

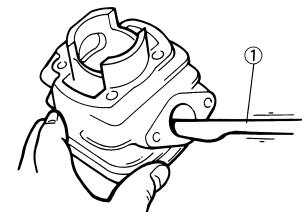

- Inspect:
 - Cylinder inner surface
Score marks → Repair or replace.
Use #400–600 grit wet sandpaper.

NOTICE

Do not rebore the cylinder.

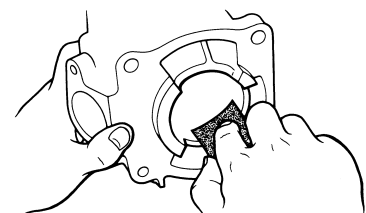

CYLINDER HEAD, CYLINDER AND PISTON

3. Measure:

- Cylinder bore "C"
Use cylinder gauge "1".
Out of specification → Replace.

TIP

Measure the cylinder bore "C" in parallel (A, B, C) to and at right angles to the crankshaft (a, b). Then, find the average of the measurements.

	Standard	Wear limit
Cylinder bore "C"	66.400–66.414 mm (2.6142–2.6147 in)	66.500 mm (2.6181 in)
Taper "T"	—	0.050 mm (0.0020 in)

"C" = Maximum Aa–Cb

"T" = (Maximum Aa, or Ab) - (Maximum Ba, or Bb)

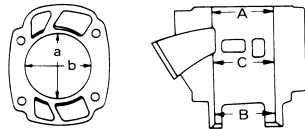
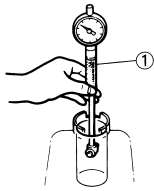

CHECKING THE PISTON

1. Eliminate:

- Carbon deposits
From the piston crown "a" and ring groove "b".

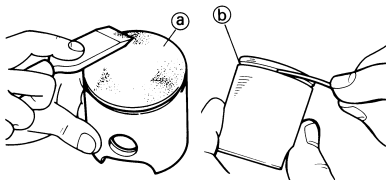

2. Inspect:

- Piston wall
Score marks → Repair or replace.

3. Measure:

- Piston skirt diameter
Use micrometer "1".
Measure the specific distance "b" from the stepped surface "a" on inside of the piston.
Out of specification → Replace.

	Distance "b"	Piston diameter
	17.5 mm (0.69 in)	66.352–66.367 mm (2.6123–2.6129 in)

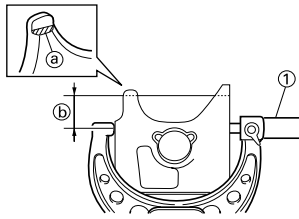

CHECKING THE PISTON PIN AND SMALL END BEARING

1. Inspect:

- Piston pin
- Small end bearing
Signs of heat discoloration → Replace.

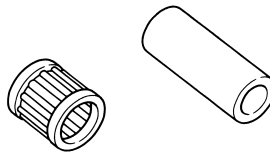

2. Measure:

- Piston pin outside diameter
Use micrometer "1".
Out of specification → Replace.

	Piston pin outside diameter:	
	Standard	<Limit>
	17.995–18.000 mm (0.7085–0.7087 in)	17.975 mm (0.7077 in)

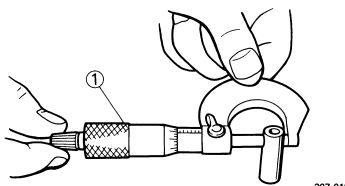

3. Check:

- Free play (when the piston pin "1" is in place in the piston "2")
There should be no noticeable for the play.
Free play exists → Replace piston pin and/or piston.

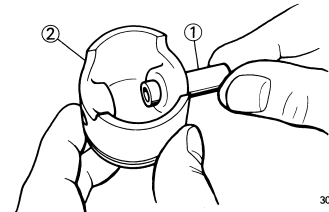

4. Install:

- Small end bearing
- Piston pin
Into the small end of connecting rod.

5. Check:

- Free play
There should be no noticeable free play.
Free play exists → Inspect the connecting rod for wear/Replace the pin and/or connecting rod as required.

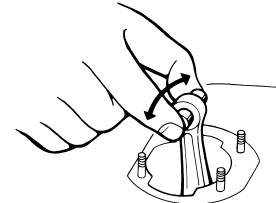

CHECKING THE PISTON RING

1. Install:

- Piston ring
Into the cylinder.
Push the ring with the piston crown.

2. Measure:

- End gap
Use a thickness gauge "1".
Out of specification → Replace.

	Ring end gap (installed):	
	Standard	<Limit>
	0.40–0.55 mm (0.0157–0.0217 in)	0.95 mm (0.0374 in)

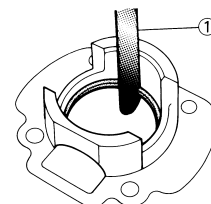

CYLINDER HEAD, CYLINDER AND PISTON

3. Measure:

- Side clearance
Use a thickness gauge "1".
Out of specification → Replace piston and/or ring.

Side clearance:	
Standard	<Limit>
0.030–0.065 mm (0.0012–0.0026 in)	0.100 mm (0.0039 in)

TIP

Check at several points.

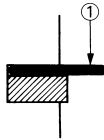
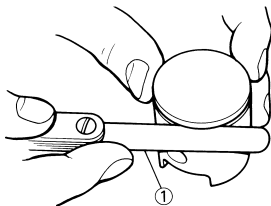

CHECKING THE PISTON CLEARANCE

1. Calculate:

- Piston clearance
Out of specification → Replace piston, and piston ring and/or cylinder.
Refer to "Cylinder" and "Piston".

PISTON CLEARANCE = CYLINDER BORE - PISTON DIAMETER

Piston clearance:	
Standard	<Limit>
0.045–0.050 mm (0.0018–0.0020 in)	0.100 mm (0.0039 in)

CHECKING THE COMBINATION OF PISTON AND CYLINDER

1. Check:

- Cylinder mark "a"

Cylinder mark "a"	Cylinder size
A	66.400–66.402 mm (2.61417–2.61425 in)
B	66.404–66.406 mm (2.61433–2.61441 in)
C	66.408–66.410 mm (2.61449–2.61457 in)
D	66.412–66.414 mm (2.61465–2.61472 in)

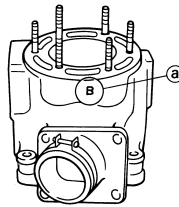

2. Check:

- Piston mark "a"

Piston mark "a" (color)	Piston size
A (red)	66.352–66.355 mm (2.61228–2.61240 in)
B (orange)	66.356–66.359 mm (2.61244–2.61256 in)
C (green)	66.360–66.363 mm (2.61260–2.61272 in)
D (purple)	66.364–66.367 mm (2.61276–2.61287 in)

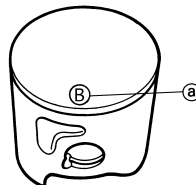

3. Combination:

Combine the piston and cylinder by the following chart.

Cylinder mark	Piston mark (color)
A	A (red)
B	B (orange)
C	C (green)
D	D (purple)

TIP

When you purchase a cylinder, you cannot designate its size. Choose the piston that matches the above chart.

CHECKING THE POWER VALVE

1. Inspect:

- Power valve 1, 2 "1"
Wear/Damage → Replace.
Carbon deposits → Remove.
- Valve holder 1 "2"
- Link lever "3"
- Pulley "4"
- Valve shaft "5"
- Link rod "6"
- Washer "7"
Wear/Damage → Replace.
- Spring 1, 2 "8"
Broken → Replace.

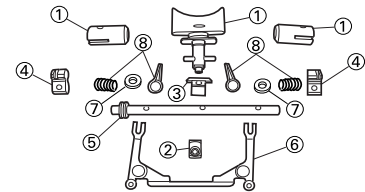

CHECKING THE POWER VALVE HOLE ON CYLINDER

1. Remove:

- Carbon deposits
From power valve hole surface "a".

TIP

Do not use a sharp instrument. Avoid scratching the aluminum.

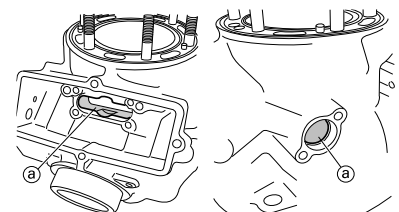

CYLINDER HEAD, CYLINDER AND PISTON

INSTALLING THE POWER VALVE

1. Install:

- Power valve 1 "1"
- Valve holder 2 "2"
- Bolt (valve holder 2) "3"



Bolt (valve holder 2)
6 Nm (0.6 m•kg, 4.3 ft•lb)

TIP

- Install the power valve 1 with its gouge "a" facing upside.
- Apply the molybdenum disulfide oil on the power valve 1.

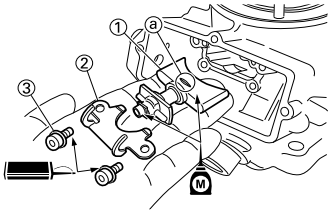

2. Install:

- Power valve 2 "1"
- Link rod "2"
- Washer "3"
- Screw (link rod) "4"



Screw (link rod):
6 Nm (0.6 m•kg, 4.3 ft•lb)

TIP

Install the link rod with the cuts "a" in its arm ends fitting over the pins "b" on the power valves 2.

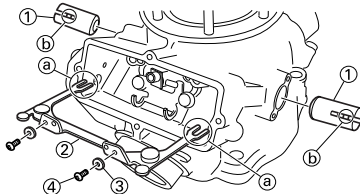

3. Install:

- Thrust plate "1"
- Screw (thrust plate) "2"



Screw (thrust plate):
6 Nm (0.6 m•kg, 4.3 ft•lb)

TIP

Be sure to install the thrust plate to the cylinder before installing the valve shaft.

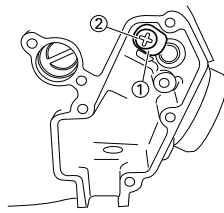

4. Check:

- Spring 1 "1"
- Link lever "2"
- Pulley "3"
- Spring 2 "4"
- Washer "5"
- Valve shaft "6"

TIP

- Install the spring 1 to the link lever, and then to the cylinder.
- Install the spring 1 with its stopper portion "a" facing inward.
- Apply the molybdenum disulfide oil on the grooves in the pulleys.
- Apply the lithium soap base grease on the oil seal lip.
- Install the valve shaft with its cut "b" aligning with the thrust plate "7", and then rotate the valve shaft so that its cut faces upward.

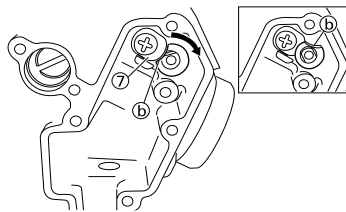
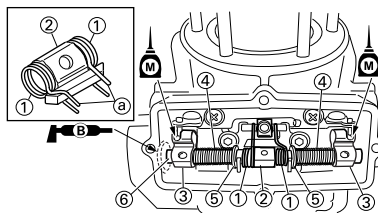

5. Install:

- Valve holder 1 "1"
- Bolt (link lever) "2"



Bolt (link lever):
4 Nm (0.4 m•kg, 2.9 ft•lb)

- Bolt (pulley) "3"



Bolt (pulley):
4 Nm (0.4 m•kg, 2.9 ft•lb)

TIP

First tighten the bolt (link lever), and then tighten the bolts (pulleys).

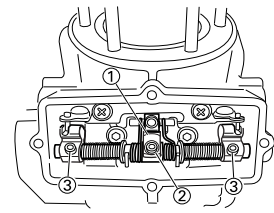

6. Check:

- Power valve 1 smooth movement
Unsmooth movement → Repair or replace.

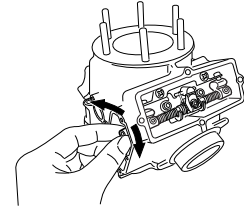

7. Install:

- O-ring "1" **New**
- Side holder "2"
- Screw (side holder) "3"



Screw (side holder):
4 Nm (0.4 m•kg, 2.9 ft•lb)

- YPVS breather hose "4"

TIP

- Apply the lithium soap base grease on the O-rings.
- Install the side holder with its projection "a" facing upward.

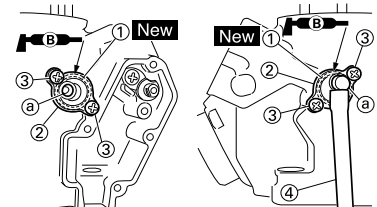

8. Install:

- Gasket (power valve cover) "1" **New**
- Power valve cover "2"
- Screw (power valve cover) "3"



Screw (power valve cover):
4 Nm (0.4 m•kg, 2.9 ft•lb)

TIP

- Install the gasket with its cut "a" facing downward and the seal print side toward the power valve cover.
- Install the power valve cover so that the arrow mark "b" faces upward.

CYLINDER HEAD, CYLINDER AND PISTON

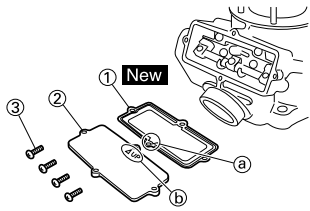

INSTALLING THE PISTON RING AND PISTON

1. Install:

- Piston ring "1"

TIP

- Take care not to scratch the piston or damage the piston ring.
- Align the piston ring gap with the pin "2".
- After installing the piston ring, check the smooth movement of it.

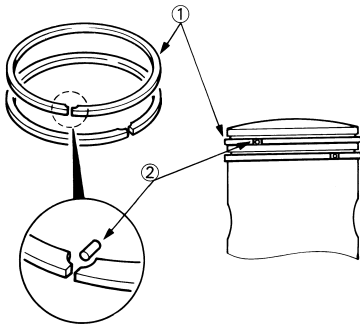

2. Install:

- Gasket (cylinder) "1" **New**
- Small end bearing "2"
- Dowel pin "3"

TIP

- Apply the engine oil onto the bearing (crankshaft and connecting rod) and connecting rod big end washers.
- Install the gasket with the seal print side toward the crankcase.

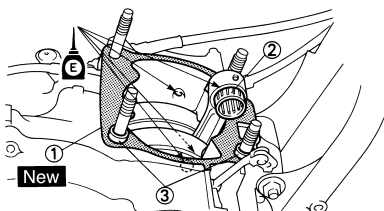

3. Install:

- Piston "1"
- Piston pin "2"
- Piston pin clip "3" **New**

TIP

- The arrow "a" on the piston dome must point to exhaust side.
- Before installing the piston pin clip, cover the crankcase with a clean rag to prevent the piston pin clip from falling into the crankcase cavity.
- Apply the engine oil on the piston pin.

NOTICE

Do not allow the clip open ends to meet the piston pin slot "b".

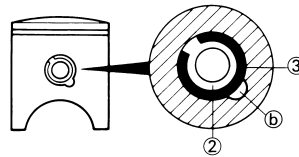
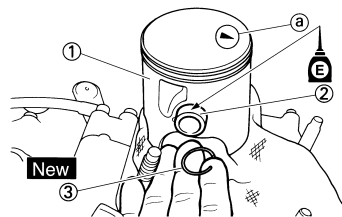

INSTALLING THE CYLINDER HEAD AND CYLINDER

1. Apply:

- Engine oil
To piston "1", piston ring "2" and cylinder surface.

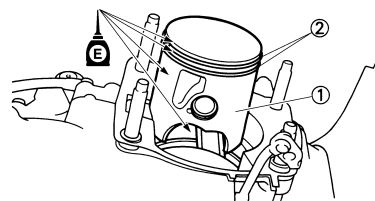

2. Install:

- Cylinder "1"

NOTICE

Make sure the piston rings are properly positioned. Install the cylinder with one hand while compressing the piston rings with the other hand.

TIP

After installing, check the smooth movement of the piston.

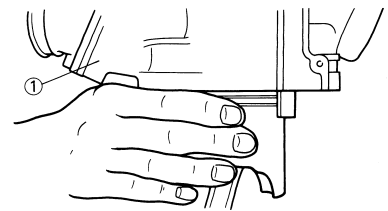

3. Install:

- Nut (cylinder) "1"



Nut (cylinder):
42 Nm (4.2 m•kg, 30 ft•lb)

TIP

Tighten the nuts in stage, using a crisscross pattern.

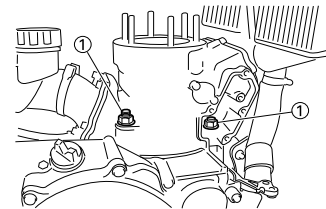

4. Install:

- Push rod "1"
- Bolt (push rod) "2"



Bolt (push rod):
5 Nm (0.5 m•kg, 3.6 ft•lb)

TIP

- Insert the set pin "3" included in owner's tool kit to install the bolt (push rod).
- Do not forget to remove the set pin.

NOTICE

Be sure to use the set pin. If the set pin is not used, the power valve constituent parts will result in damage.

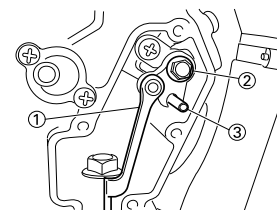

CYLINDER HEAD, CYLINDER AND PISTON

5. Install:

- Gasket (power valve housing) **New**
- Power valve housing "1"
- Bolt (power valve housing) "2"

	Bolt (power valve housing): 5 Nm (0.5 m•kg, 3.6 ft•lb)
---	--

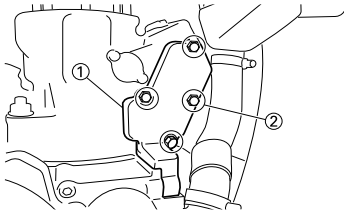

6. Install:

- O-ring "1" **New**
- Dowel pin "2"

TIP

Apply the lithium soap base grease on the O-rings.

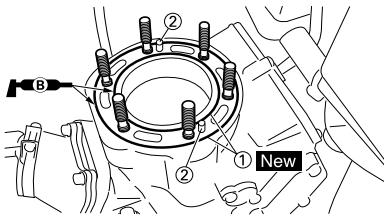

7. Install:

- Cylinder head "1"
- Copper washer "2" **New**
- Nut (cylinder head) "3"

	Nut (cylinder head): 25 Nm (2.5 m•kg, 18 ft•lb)
---	---

TIP

Tighten the nuts (cylinder head) in stage, using a crisscross pattern.

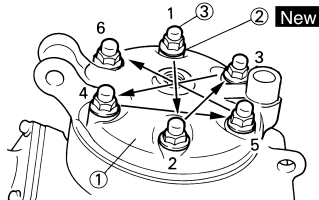

8. Install:

- Engine bracket "1"
- Bolt (engine bracket) "2"

	Bolt (engine bracket): 34 Nm (3.4 m•kg, 24 ft•lb)
---	---

- Engine mounting bolt (upper) "3"

	Engine mounting bolt (upper): 64 Nm (6.4 m•kg, 46 ft•lb)
---	--

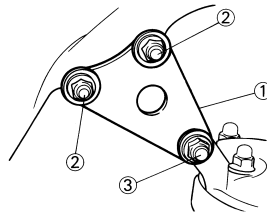

9. Install:

- Spark plug "1"

	Spark plug: 20 Nm (2.0 m•kg, 14 ft•lb)
---	--

- Spark plug cap "2"

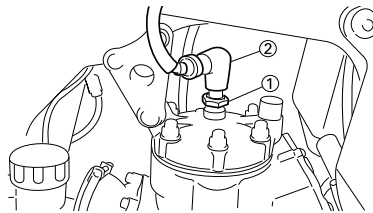

CLUTCH

REMOVING THE CLUTCH

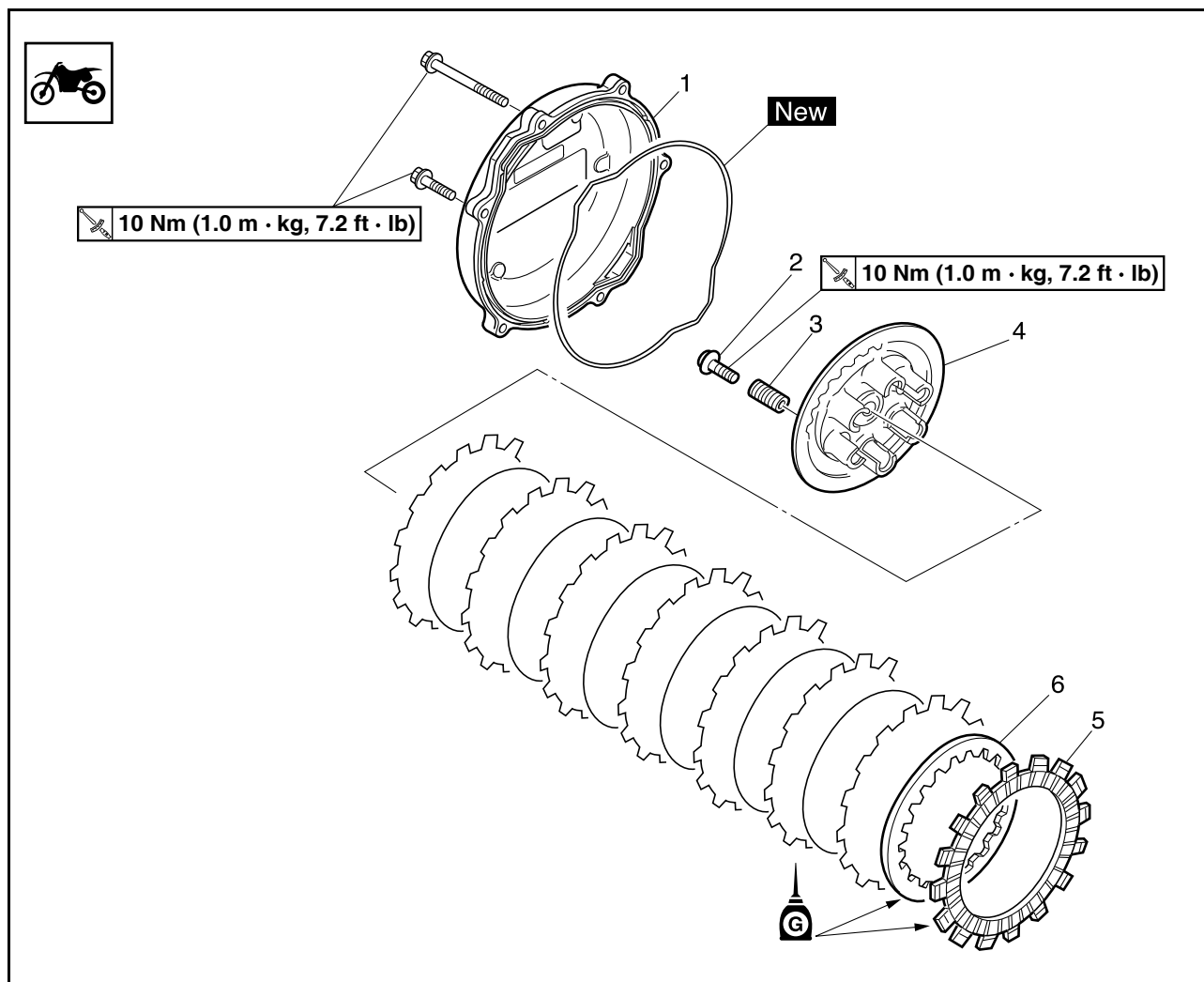

Order	Part name	Q'ty	Remarks
	Drain the transmission oil.		Refer to "CHANGING THE TRANSMISSION OIL" section in the CHAPTER 3.
	Bolt (brake pedal)		Shift the brake pedal downward.
	Rotor and stator		Refer to "CDI MAGNETO" section.
	Clutch cable		Disconnect at engine side.
1	Clutch cover	1	
2	Bolt (clutch spring)	6	
3	Clutch spring	6	
4	Pressure plate	1	
5	Friction plate	8	
6	Clutch plate	7	

REMOVING THE CLUTCH BOSS

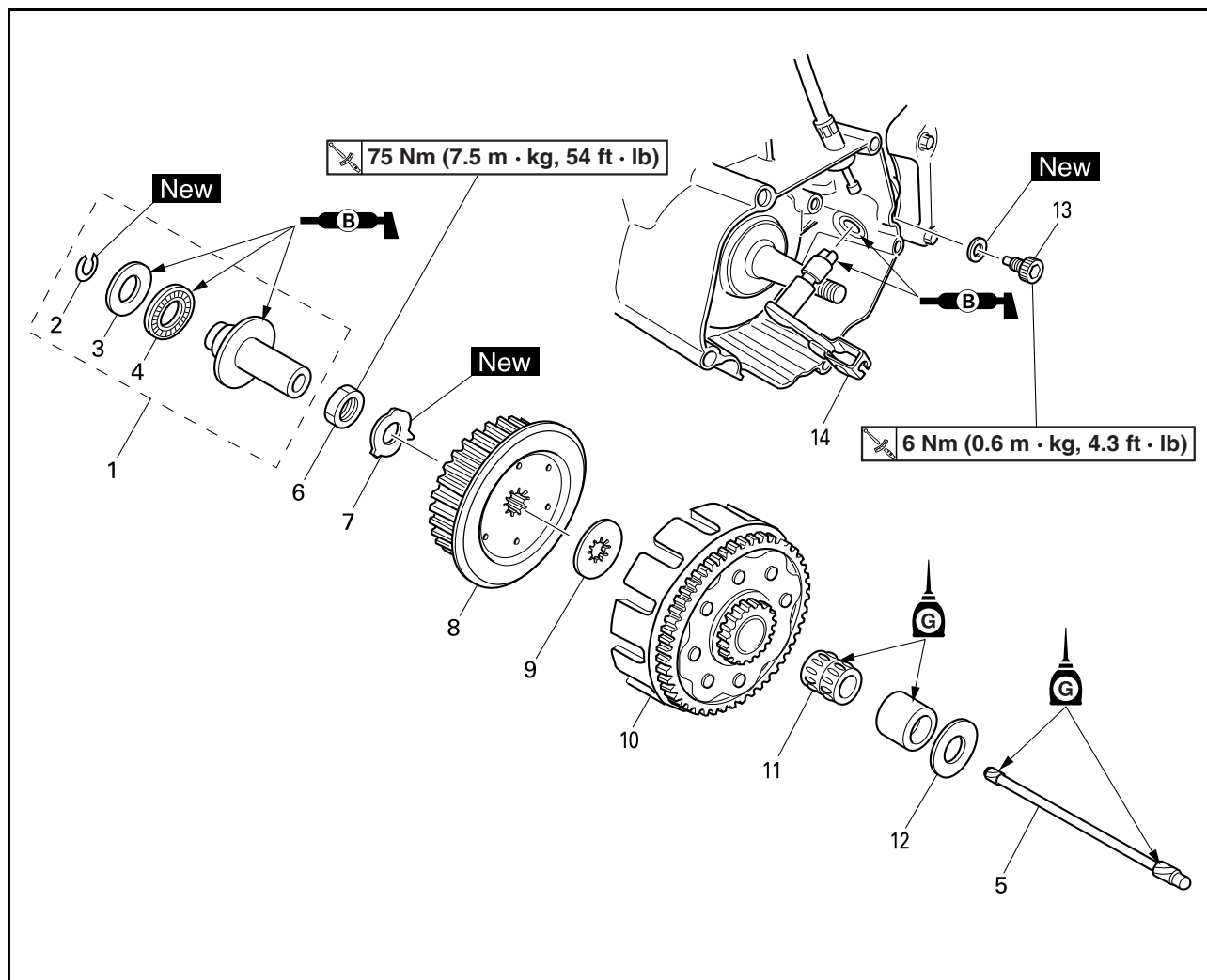

Order	Part name	Q'ty	Remarks
1	Push rod 1	1	
2	Circlip	1	
3	Washer	1	
4	Bearing	1	
5	Push rod 2	1	
6	Nut (clutch boss)	1	Refer to removal section.
7	Lock washer	1	Refer to removal section.
8	Clutch boss	1	Refer to removal section.
9	Thrust washer [D=ø44mm (1.73 in)]	1	
10	Primary driven gear	1	
11	Bearing	1	
12	Thrust washer [D=ø42mm (1.65 in)]	1	
13	Bolt (push lever shaft)	1	
14	Push lever shaft	1	

REMOVING THE CLUTCH BOSS

- Remove:
 - Nut "1"
 - Lock washer "2"
 - Clutch boss "3"

TIP

Straighten the lock washer tab and use the clutch holding tool "4" to hold the clutch boss.

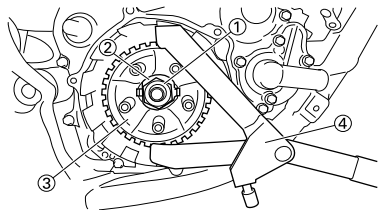

A

B

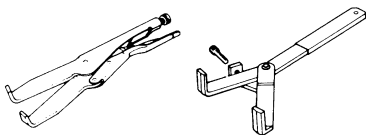

A. For USA and CDN

B. Except for USA and CDN

CHECKING THE CLUTCH HOUSING AND BOSS

- Inspect:
 - Clutch housing "1"
Cracks/wear/damage → Replace.
 - Clutch boss "2"
Scoring/wear/damage → Replace.

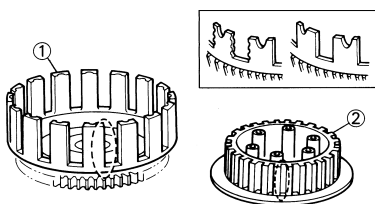

CHECKING THE PRIMARY DRIVEN GEAR

- Check:
 - Circumferential play
Free play exists → Replace.
 - Gear teeth "a"
Wear/damage → Replace.



311-021

CHECKING THE CLUTCH SPRINGS

- Measure:
 - Clutch spring free length "a"
Out of specification → Replace
springs as a set.

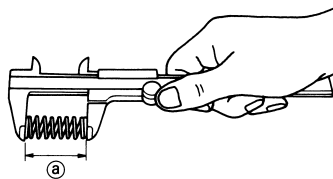
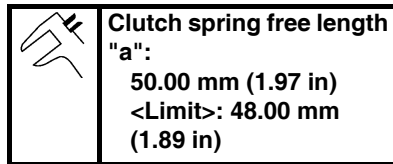

CHECKING THE FRICTION PLATES

- Measure:
 - Friction plate thickness
Out of specification → Replace
friction plate as a set.
Measure at all four points.

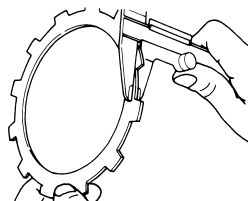
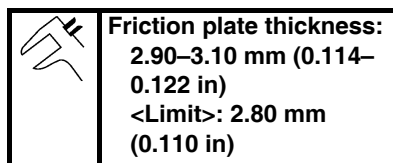

CHECKING THE CLUTCH PLATES

- Measure:
 - Clutch plate warpage
Out of specification → Replace
clutch plate as a set.
Use a surface plate "1" and thickness gauge "2".

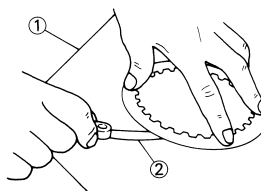
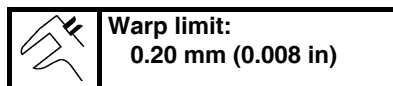

CHECKING THE PUSH LEVER SHAFT

- Inspect:
 - Push lever shaft "1"
Wear/Damage → Replace.

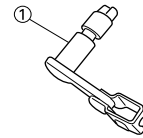

CHECKING THE PUSH ROD

- Inspect:
 - Push rod 1 "1"
 - Bearing "2"
 - Washer "3"
 - Push rod 2 "4"
Wear/damage/bend → Replace.

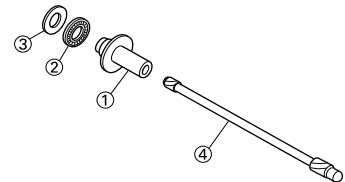

INSTALLING THE PUSH LEVER SHAFT

- Install:
 - Push lever shaft "1"
 - Copper washer "2" **New**
 - Bolt (push lever shaft) "3"

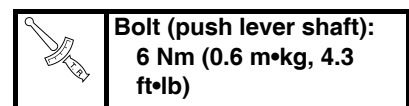

TIP

Apply the lithium soap base grease on the oil seal lip and push lever shaft.

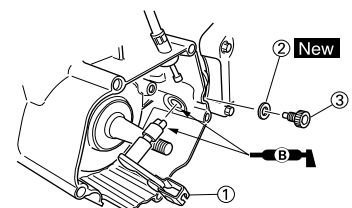

INSTALLING THE CLUTCH

- Install:
 - Thrust washer [D=ø42 mm (1.65 in)] "1"
 - Spacer "2"
 - Bearing "3"
 - Primary driven gear "4"

TIP

Apply the transmission oil on the bearing, spacer and primary driven gear inner circumference.

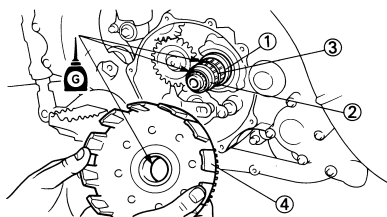

2. Install:
- Thrust washer [D=ø44 mm (1.73 in)] "1"
 - Clutch boss "2"

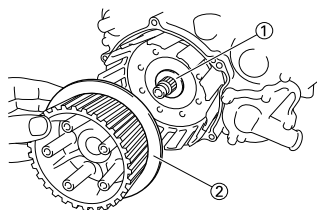

3. Install:
- Lock washer "1" **New**
 - Nut (clutch boss) "2"



Nut (clutch boss):
75 Nm (7.5 m•kg, 54 ft•lb)

TIP

Use the clutch holding tool "3" to hold the clutch boss.



Clutch holding tool:
YM-91042/90890-04086

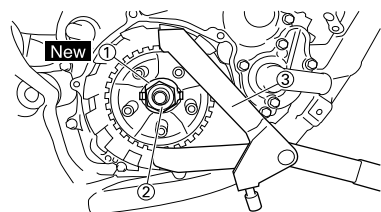

A

B

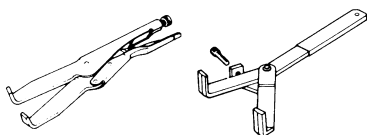

- A. For USA and CDN
B. Except for USA and CDN

4. Bend the lock washer "1" tab.

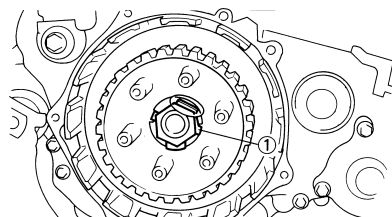

5. Install:
- Friction plate "1"
 - Clutch plate "2"

TIP

- Install the clutch plates and friction plates alternately on the clutch boss, starting with a friction plate and ending with a friction plate.
- Apply the transmission oil on the friction plates and clutch plates.

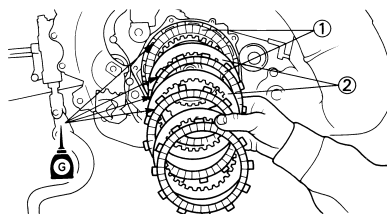

6. Install:
- Bearing "1"
 - Washer "2"
 - Circlip "3" **New**
- To push rod 1 "4".

TIP

Apply the lithium soap base grease on the bearing and washer.

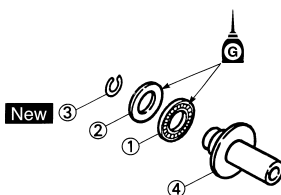

7. Install:
- Push rod 2 "1"
 - Push rod 1 "2"

TIP

- Apply the transmission oil on the ends of the push rod 2.
- Install the push rod 2 with its smaller end "a" toward you.

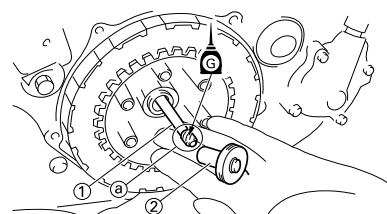

8. Install:
- Pressure plate "1"

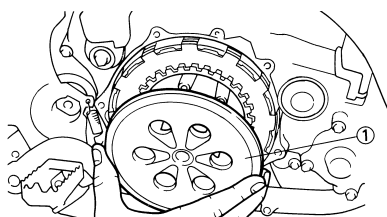

9. Install:
- Clutch spring "1"
 - Bolt (clutch spring) "2"



Bolt (clutch spring):
10 Nm (1.0 m•kg, 7.2 ft•lb)

TIP

Tighten the bolts in stage, using a crisscross pattern.

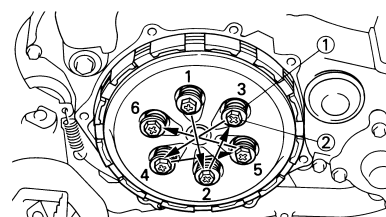

10. Install:
- O-ring "1" **New**
- To clutch cover.

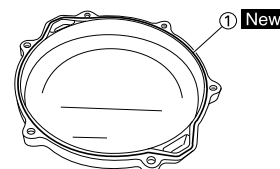

11. Install:
- Clutch cover "1"
 - Bolt (clutch cover) "2"



Bolt (clutch cover):
10 Nm (1.0 m•kg, 7.2 ft•lb)

TIP

Tighten the bolts in stage, using a crisscross pattern.

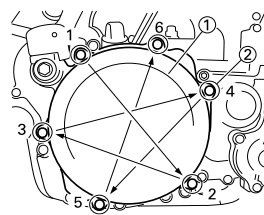

12. Install:
- O-ring "1" **New**
 - Clutch cable "2"

TIP

Apply the lithium soap base grease on the O-ring.

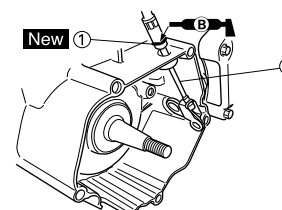

KICK SHAFT AND SHIFT SHAFT

KICK SHAFT AND SHIFT SHAFT REMOVING THE PRIMARY DRIVE GEAR

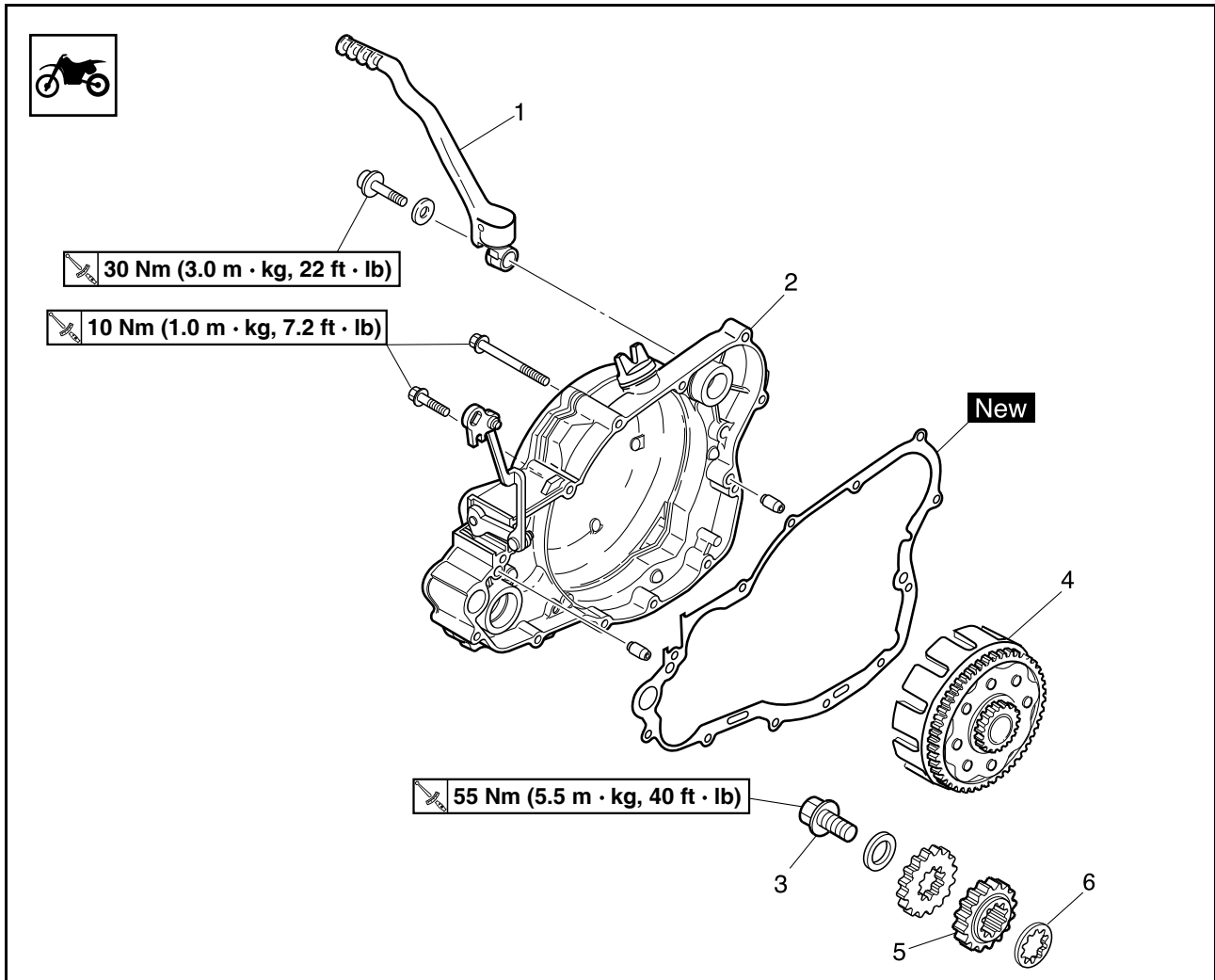

Order	Part name	Q'ty	Remarks
	Drain the transmission oil.		Refer to "CHANGING THE TRANSMISSION OIL" section in the CHAPTER 3.
	Bolt (brake pedal)		Shift the brake pedal downward.
	Radiator hose 4		Disconnect at water pump side.
	Bolt (push rod)		Refer to "CYLINDER HEAD, CYLINDER AND PISTON" section.
1	Kickstarter lever	1	
2	Crankcase cover (right)	1	
3	Bolt (Primary drive gear)	1	Only loosening. Refer to removal section.
4	Primary driven gear	1	Refer to "CLUTCH" section.
5	Primary drive gear	1	
6	Thrust plate	1	

KICK SHAFT AND SHIFT SHAFT

REMOVING THE KICK SHAFT AND SHIFT SHAFT

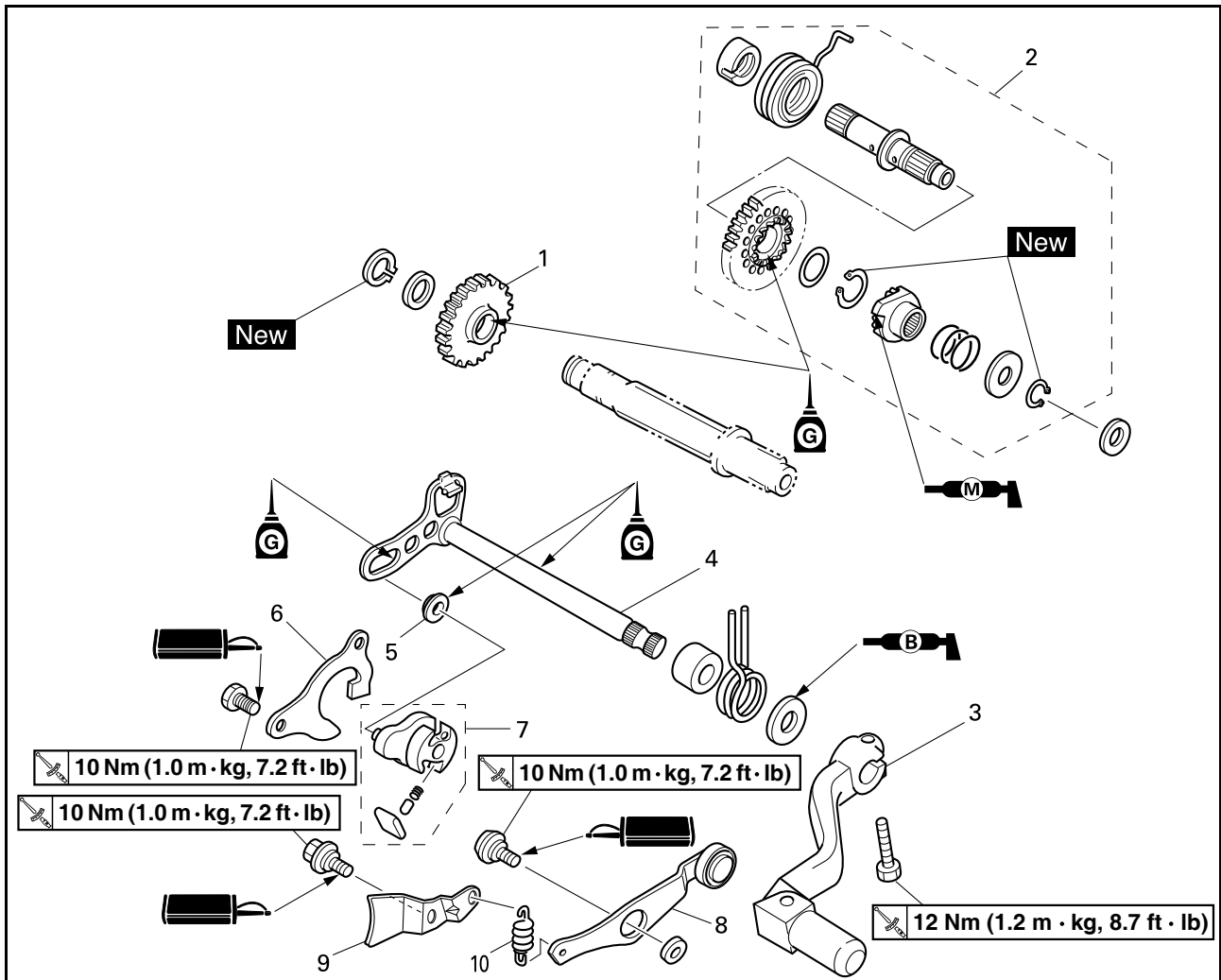

Order	Part name	Q'ty	Remarks
1	Kick idle gear	1	
2	kick shaft assembly	1	Refer to removal section.
3	Shift pedal	1	
4	Shift shaft	1	
5	Roller	1	
6	Shift guide	1	Refer to removal section.
7	Shift lever assembly	1	Refer to removal section.
8	Stopper lever	1	
9	Holder	1	
10	Tension spring	1	

KICK SHAFT AND SHIFT SHAFT

REMOVING THE PRIMARY DRIVE GEAR

- Loosen:
 - Bolt (primary drive gear) "1"

TIP

Place an aluminum plate "a" between the teeth of the primary drive gear "2" and driven gear "3".

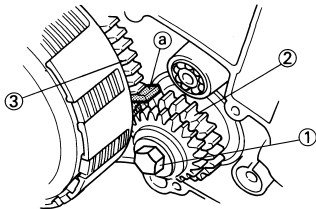

REMOVING THE KICK SHAFT ASSEMBLY

- Remove:
 - Kick shaft assembly "1"

TIP

Unhook the torsion spring "2" from the hole "a" in the crankcase.

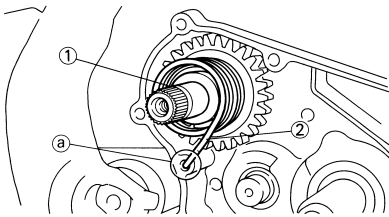

REMOVING THE SHIFT GUIDE AND SHIFT LEVER ASSEMBLY

- Remove:
 - Bolt (shift guide)
 - Shift guide "1"
 - Shift lever assembly "2"

TIP

The shift lever assembly is disassembled at the same time as the shift guide.

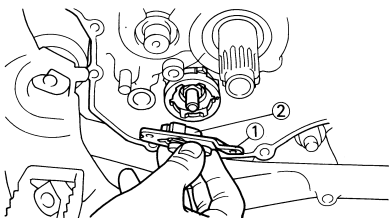

REMOVING THE SEGMENT

- Remove:
 - Bolt (segment) "1"
 - Segment "2"

TIP

Turn the segment counterclockwise until it stops and loosen the bolt.

NOTICE

If the segment gets an impact, the stopper lever may be damaged. Take care not to give an impact to it when removing the bolt.

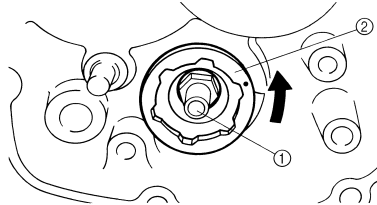

CHECKING THE KICK SHAFT AND RATCHET WHEEL

- Check:
 - Ratchet wheel "1" smooth movement
Unsmooth movement → Replace.
 - Kick shaft "2"
Wear/damage → Replace.
 - Spring "3"
Broken → Replace.

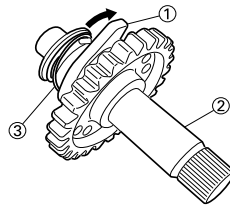

CHECKING THE KICK GEAR, KICK IDLE GEAR AND RATCHET WHEEL

- Inspect:
 - Kick gear "1"
 - Kick idle gear "2"
 - Ratchet wheel "3"
 - Gear teeth "a"
 - Ratchet teeth "b"
Wear/damage → Replace.

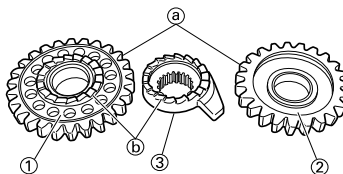

CHECKING THE SHIFT SHAFT

- Inspect:
 - Shift shaft "1"
Bend/damage → Replace.
 - Spring "2"
Broken → Replace.

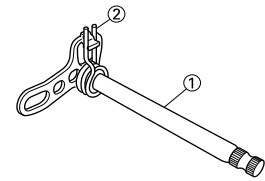

CHECKING THE SHIFT GUIDE AND SHIFT LEVER ASSEMBLY

- Inspect:
 - Shift guide "1"
 - Shift lever "2"
 - Pawl "3"
 - Pawl pin "4"
 - Spring "5"
Wear/damage → Replace.

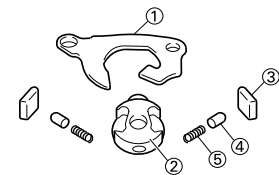

CHECKING THE STOPPER LEVER

- Inspect:
 - Stopper lever "1"
Wear/damage → Replace.
 - Bearing "2"
Rotate outer race with a finger.
Rough spot/Seizure → Replace the stopper lever.
 - Torsion spring "3"
Broken → Replace.

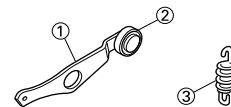

CHECKING THE PRIMARY DRIVE GEAR AND PRIMARY DRIVEN GEAR

- Inspect:
 - Primary drive gear "1"
 - Primary driven gear "2"
Wear/Damage → Replace.

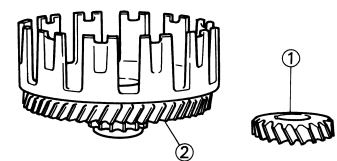

KICK SHAFT AND SHIFT SHAFT

INSTALLING THE SEGMENT

- Install:
 - Segment "1"
 - Bolt (segment)



Bolt (segment):
30 Nm (3.0 m•kg, 22 ft•lb)

TIP

Align the notch "a" on the segment with the pin "b" on the shift cam.

NOTICE

If the segment gets an impact, the stopper lever may be damaged. Take care not to give an impact to it when tightening the bolt.

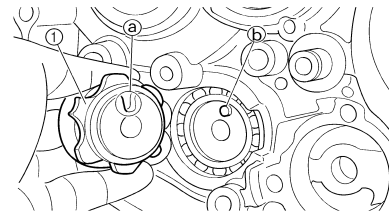

INSTALLING THE STOPPER LEVER

- Install:
 - Torsion spring "1"
 - Holder "2"
 - Bolt (holder) "3"



Bolt (holder):
10 Nm (1.0 m•kg, 7.2 ft•lb)

- Washer "4"
- Stopper lever "5"
- Bolt (topper lever) "6"



Bolt (stopper lever):
10 Nm (1.0 m•kg, 7.2 ft•lb)

TIP

Align the stopper lever roller with the slot on segment.

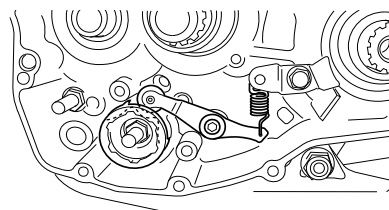
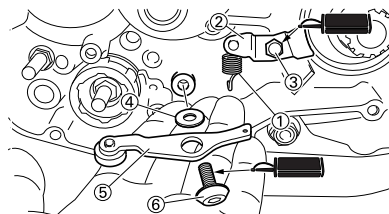

INSTALLING THE SHIFT GUIDE AND SHIFT LEVER ASSEMBLY

- Install:
 - Spring "1"
 - Pawl pin "2"
 - Pawl "3"
 To shift lever "4".

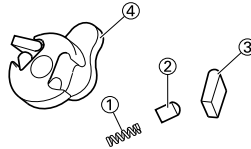

- Install:
 - Shift lever assembly "1"
 To shift guide "2".

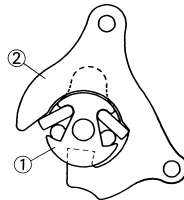

- Install:
 - Shift lever assembly "1"
 - Shift guide "2"

TIP

- The shift lever assembly is installed at the same time as the shift guide.
- Apply the transmission oil on the bolt (segment) shaft.

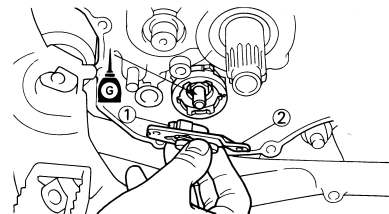

- Install:
 - Bolt (shift guide) "1"



Bolt (shift guide):
10 Nm (1.0 m•kg, 7.2 ft•lb)

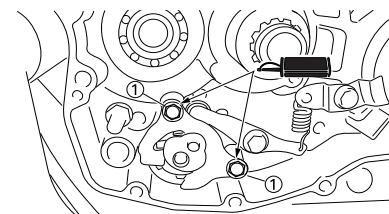

INSTALLING THE SHIFT SHAFT

- Install:
 - Roller "1"
 - Washer "2"
 - Shift shaft "3"

TIP

Apply the transmission oil on the roller and shift shaft.

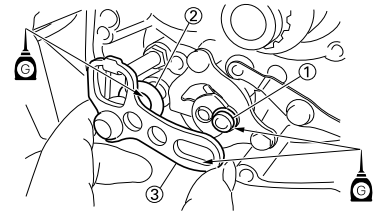

INSTALLING THE KICK SHAFT ASSEMBLY

- Install:
 - Kick gear "1"
 - Washer "2"
 - Circlip "3" **New**
 - Ratchet wheel "4"
 - Spring "5"
 - Washer "6"
 - Circlip "7" **New**
 To kick shaft "8".

TIP

- Apply the transmission oil on the kick gear inner circumference.
- Align the punch mark "a" on the ratchet wheel with the punch mark "b" on the kick shaft.

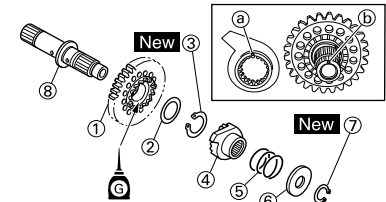

- Install:
 - Torsion spring "1"
 To kick shaft "2".

TIP

Make sure the stopper "a" of the torsion spring fits into the hole "b" on the kick shaft.

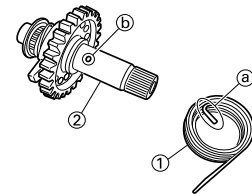

KICK SHAFT AND SHIFT SHAFT

3. Install:

- Spring guide "1"

TIP

Slide the spring guide into the kick shaft, make sure the groove "a" in the spring guide fits on the stopper of the torsion spring.

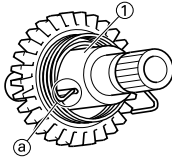

4. Install:

- Washer "1"
- Kick shaft assembly "2"

TIP

- Apply the molybdenum disulfide grease on the contacting surfaces of the kick shaft stopper "a" and stopper plate "3".
- Apply the transmission oil on the kick shaft.
- Slide the kick shaft assembly into the crankcase and make sure the kick shaft stopper fits into the stopper plate.

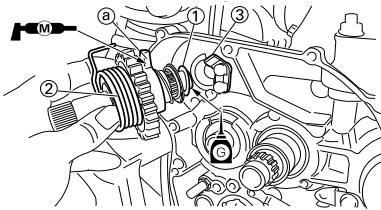

5. Hook:

- Torsion spring "1"

TIP

Turn the torsion spring clockwise and hook into the proper hole "a" in the crankcase.

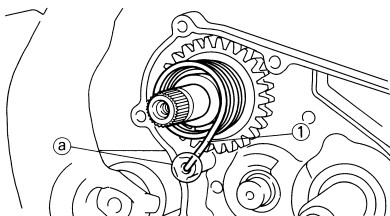

INSTALLING THE KICK IDLE GEAR

1. Install:

- Kick idle gear "1"
- Washer "2"
- Circlip "3" **New**

TIP

- Apply the transmission oil on the kick idle gear inner circumference.
- Install the kick idle gear with its depressed side "a" toward you.

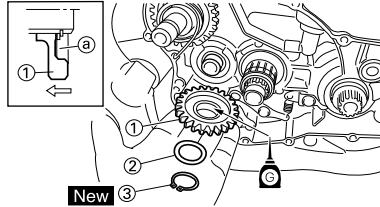

INSTALLING THE PRIMARY DRIVE GEAR

1. Install:

- Thrust plate "1"
- Primary drive gear "2"
- Governor drive gear "3"
- Washer "4"
- Bolt (primary drive gear) "5"

TIP

- Install the plain washer with its chamfered side "a" toward you.
- Temporarily tighten the bolt at this point.

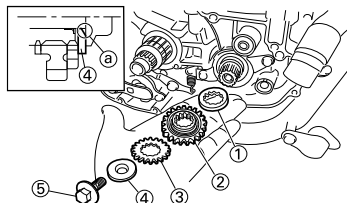

2. Install:

- Primary driven gear
- Refer to "CLUTCH" section.

3. Tighten:

- Bolt (primary drive gear) "1"

	Bolt (primary drive gear): 55 Nm (5.5 m•kg, 40 ft•lb)
---	---

TIP

Place an aluminum plate "a" between the teeth of the primary drive gear "2" and driven gear "3".

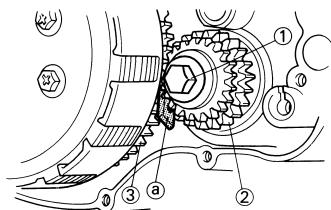

4. Install:

- Dowel pin "1"
- Gasket [crankcase cover (right)] "2" **New**

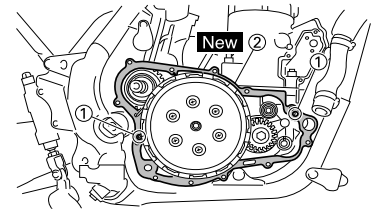

5. Install:

- Crankcase cover (right) "1"

TIP

Mesh the governor gear "2" with the governor drive gear "3" and the impeller shaft gear "4" with the primary drive gear "5".

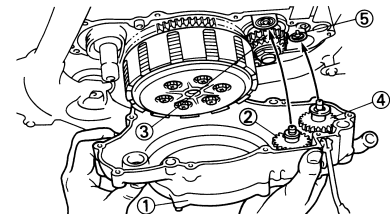

6. Install:

- Bolt [crankcase cover (right)] "1"

	Bolt [crankcase cover (right)]: 10 Nm (1.0 m•kg, 7.2 ft•lb)
--	---

TIP

Tighten the bolts in stage, using a crisscross pattern.

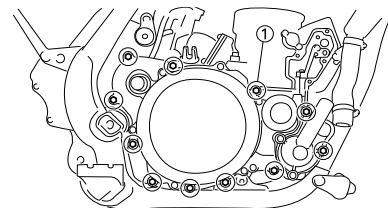

7. Install:

- Kick starter "1"
- Washer "2"
- Bolt (kick starter) "3"

	Bolt (kick starter): 30 Nm (3.0 m•kg, 22 ft•lb)
---	---

TIP

Install the kick starter closest to but not contacting the clutch cover mounting boss "a".

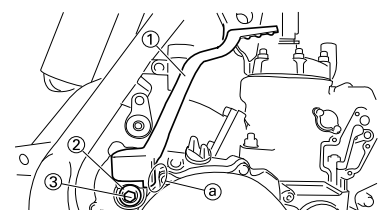

KICK SHAFT AND SHIFT SHAFT

8. Install:

- Shift pedal "1"
- Bolt (shift pedal) "2"

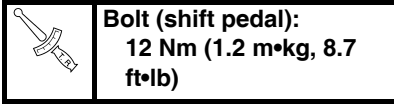

TIP

Install the shift pedal so that the top of the shift pedal outer diameter "a" is highest without exceeding the line "b" connecting the center of the shift shaft and bottom of the screw [crank-case cover (left)] "3".

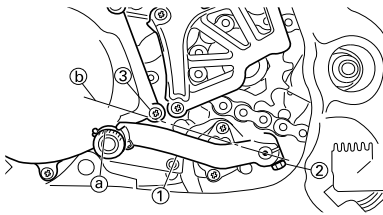

YPVS GOVERNOR

REMOVING THE YPVS GOVERNOR

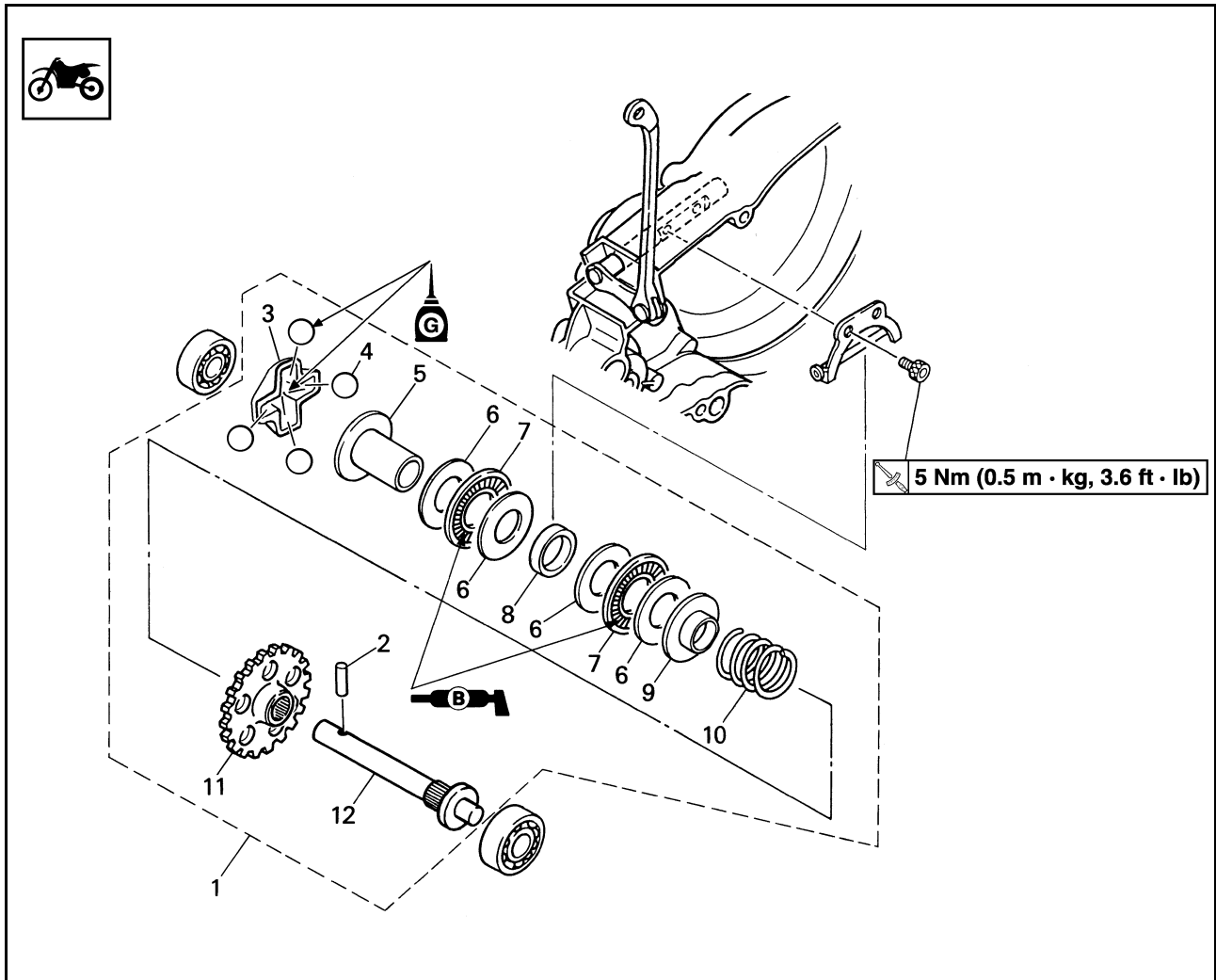

Order	Part name	Q'ty	Remarks
	Crankcase cover (right)		Refer to "KICK SHAFT AND SHIFT SHAFT" section.
1	Governor assembly	1	
2	Dowel pin	1	Refer to removal section.
3	Retainer	1	
4	Ball	4	
5	Retainer weight	1	
6	Washer	4	
7	Thrust bearing	2	
8	Collar	1	
9	Plate	1	
10	Compression spring	1	
11	Governor gear	1	
12	Governor shaft	1	

REMOVING THE GOVERNOR

- Remove:
 - Dowel pin "1"

TIP

While compressing the spring, remove the dowel pin.

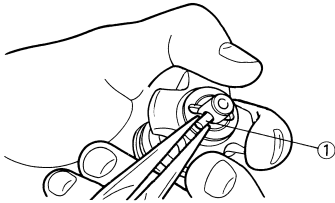

CHECKING THE GOVERNOR GROOVE

- Inspect:
 - Washer "1"
 - Collar "2"
 Wear/Damage → Replace.

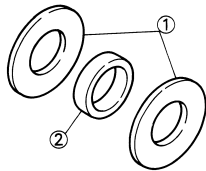

CHECKING THE BEARING

- Inspect:
 - Thrust bearing "1"
 - Washer "2"
 Wear/Damage → Replace.

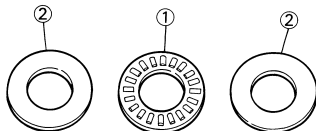

INSTALLING THE GOVERNOR

- Install:
 - Governor gear "1"
 - Compression spring "2"
 - Plate "3"
 - Washer "4"
 - Thrust bearing "5"
 - Collar "6"
 - Retainer weight "7"
 To governor shaft "8".

TIP

Apply the lithium soap base grease on the thrust bearing.

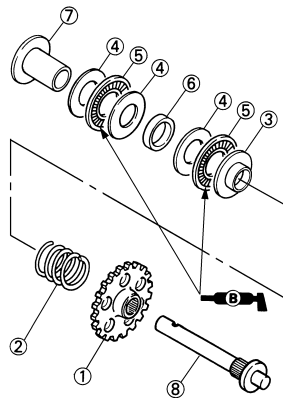

- Install:
 - Ball "1"
 - Retainer "2"
 To governor shaft "3".

TIP

Apply the transmission oil on the retainer and ball.

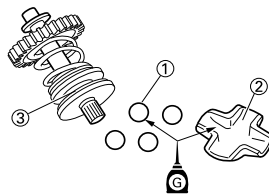

- Install:
 - Dowel pin "1"

TIP

- While compressing the spring, install the dowel pin.
- Make sure the dowel pin fits into the groove "a" in the retainer.

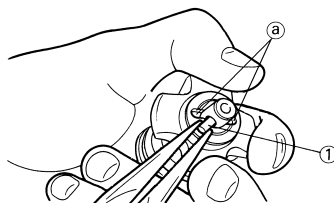

- Install:
 - Governor assembly "1"

TIP

Align the groove "a" in the governor with the fork "b" and set the governor in the crankcase cover.

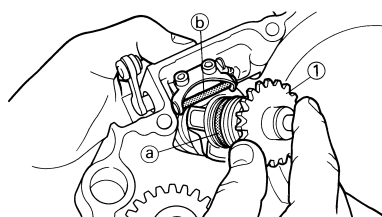

WATER PUMP

WATER PUMP

DISASSEMBLING THE WATER PUMP

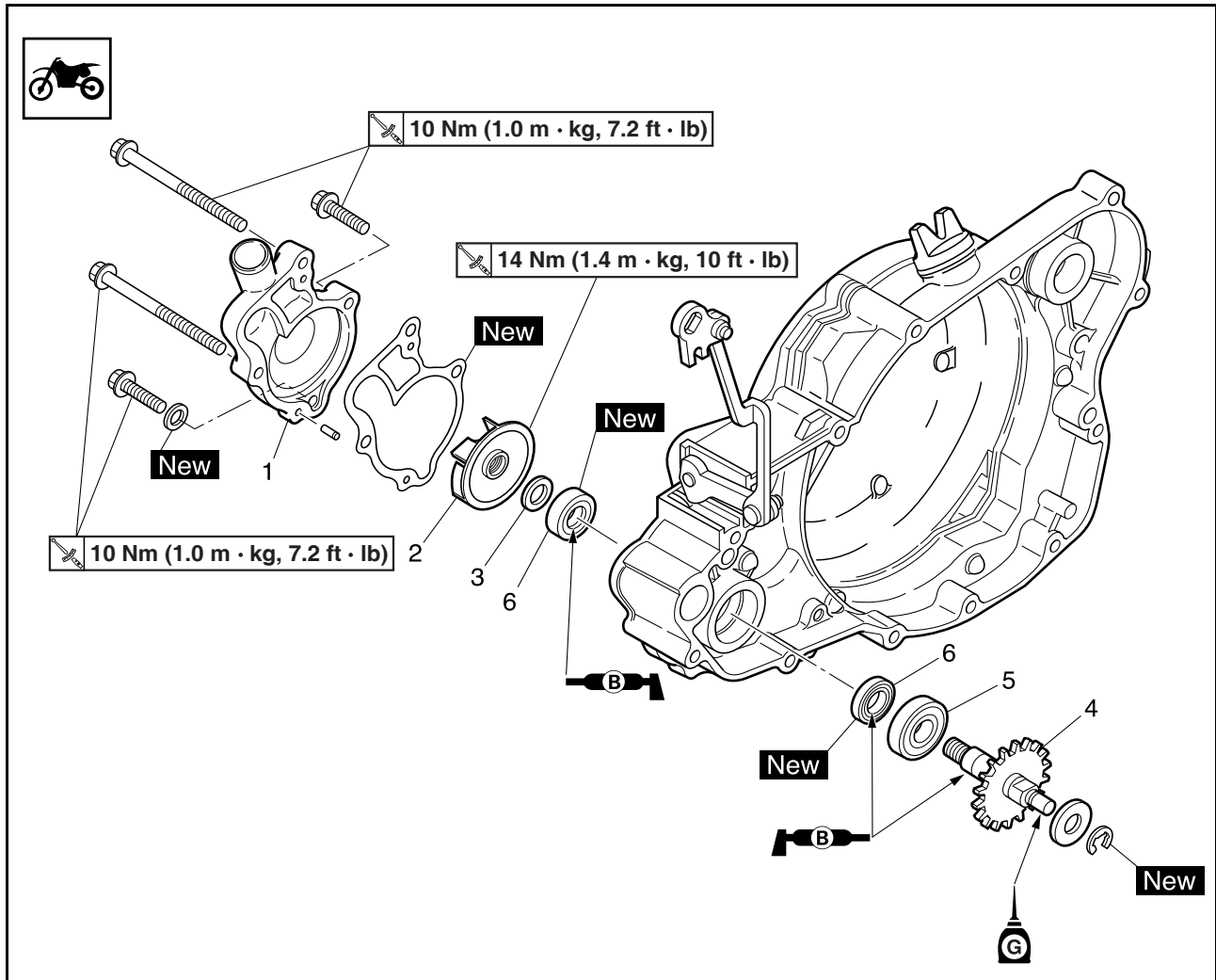

Order	Part name	Q'ty	Remarks
	Crankcase cover (right)		Refer to "KICK SHAFT AND SHIFT SHAFT" section.
1	Water pump housing cover	1	
2	Impeller	1	Refer to removal section.
3	Washer	1	Refer to removal section.
4	Impeller shaft	1	Refer to removal section.
5	Bearing	1	Refer to removal section.
6	Oil seal	2	Refer to removal section.

REMOVING THE IMPELLER SHAFT

- Remove:
 - Impeller "1"
 - Washer "2"
 - Impeller shaft "3"

TIP

Hold the impeller shaft on its width across the flats "a" with spanners, etc. and remove the impeller.

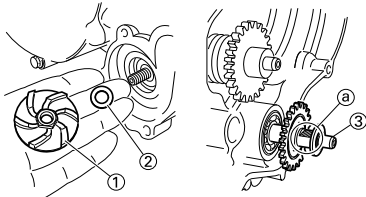

REMOVING THE OIL SEAL

TIP

It is not necessary to disassemble the water pump, unless there is an abnormality such as excessive change in coolant level, discoloration of coolant, or milky transmission oil.

- Remove:
 - Bearing "1"

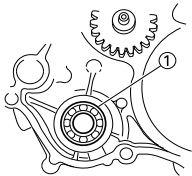

- Remove:
 - Oil seal "1"

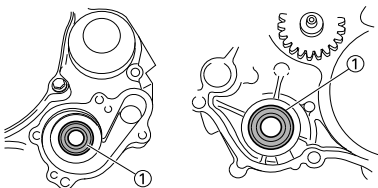

CHECKING THE IMPELLER SHAFT

- Inspect:
 - Impeller shaft "1"
 Bend/wear/damage → Replace.
 Fur deposits → Clean.

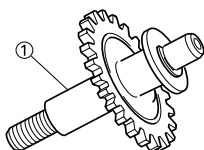

CHECKING THE IMPELLER SHAFT GEAR

- Inspect:
 - Gear teeth "a"
 Wear/damage → Replace.

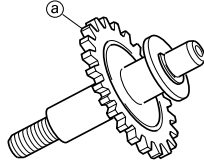

CHECKING THE BEARING

- Inspect:
 - Bearing "1"
 Rotate inner race with a finger.
 Rough spot/seizure → Replace.

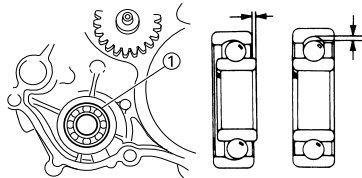

CHECKING THE OIL SEAL

- Inspect:
 - Oil seal "1"
 Wear/damage → Replace.

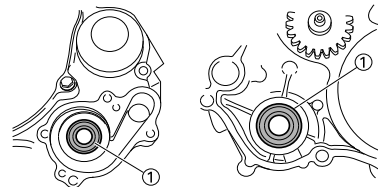

INSTALLING THE OIL SEAL

- Install:
 - Oil seal "1" **New**

TIP

- Apply the lithium soap base grease on the oil seal lip.
- Install the oil seal with its manufacturer's marks or numbers facing the right crankcase cover "2".

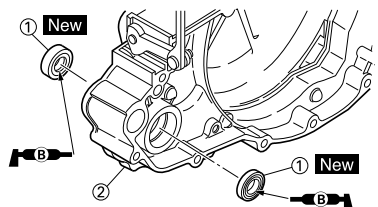

- Install:
 - Bearing "1"

TIP
Install the bearing by pressing its outer race parallel.

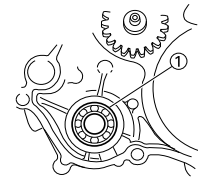

INSTALLING THE IMPELLER SHAFT

- Install:
 - Impeller shaft "1"

TIP

- Take care so that the oil seal lip is not damaged or the spring does not slip off its position.
- When installing the impeller shaft, apply the lithium soap base grease on the oil seal lip and impeller shaft. And install the shaft while turning it.

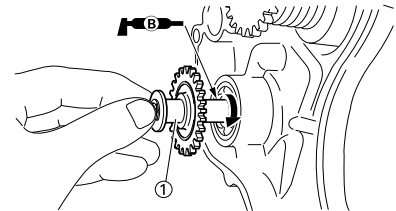

- Install:
 - Washer "1"
 - Impeller "2"

	Impeller: 14 Nm (1.4 m•kg, 10 ft•lb)
---	---

TIP

Hold the impeller shaft on its width across the flats "a", etc. and install the impeller.

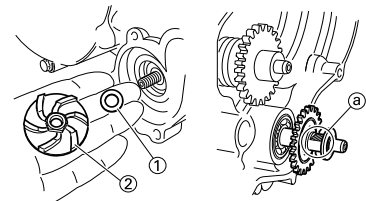

- Install:
 - Dowel pin "1"
 - Gasket (water pump housing cover) "2" **New**

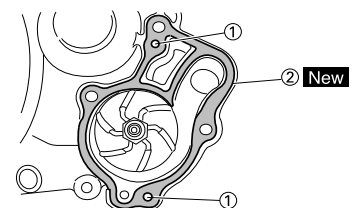

WATER PUMP

4. Install:

- Water pump housing cover "1"
- Bolt (water pump housing cover) "2"

	Bolt (water pump housing cover): 10 Nm (1.0 m•kg, 7.2 ft•lb)
---	--

- Copper washer (coolant drain bolt) "3" **New**
- Coolant drain bolt "4"

	Coolant drain bolt: 10 Nm (1.0 m•kg, 7.2 ft•lb)
---	---

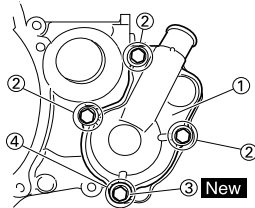

CDI MAGNETO

REMOVING THE CDI MAGNETO

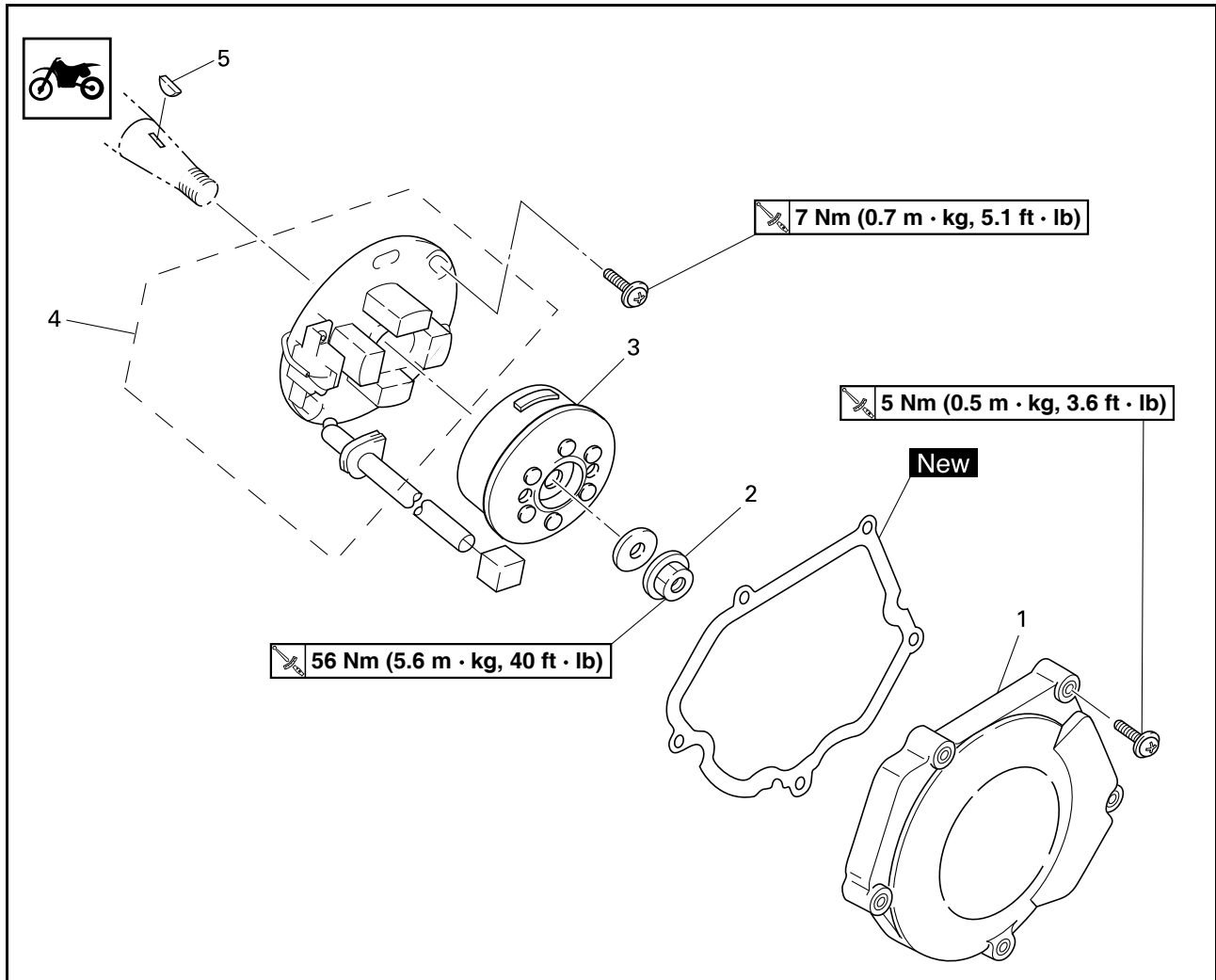

Order	Part name	Q'ty	Remarks
	Seat and fuel tank		Refer to "SEAT, FUEL TANK AND SIDE COVERS" section.
	Bolt (Radiator)		Refer to "RADIATOR" section.
	Disconnect the CDI magneto lead.		
1	Left crankcase cover	1	
2	Nut (rotor)	1	Refer to removal section.
3	Rotor	1	Refer to removal section.
4	Stator	1	
5	Woodruff key	1	

REMOVING THE ROTOR

- Remove:
 - Nut (rotor) "1"
 - Washer "2"
 Use the rotor holding tool "3".



Rotor holding tool:
YU-01235/90890-01235

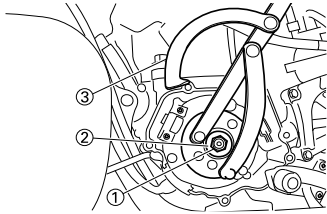

- Remove:
 - Rotor "1"
 Use the flywheel puller "2".



Flywheel puller:
YM-01189/90890-01189

TIP
When installing the flywheel puller, turn it counterclockwise.

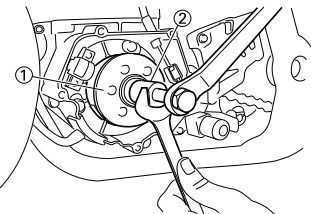

CHECKING THE CDI MAGNETO

- Inspect:
 - Rotor inner surface "a"
 - Stator outer surface "b"
 Damage → Inspect the crankshaft runout and crankshaft bearing. If necessary, replace CDI magneto and/or stator.

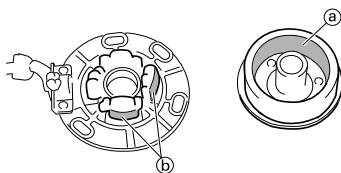

CHECKING THE WOODRUFF KEY

- Inspect:
 - Woodruff key "1"
 Damage → Replace.

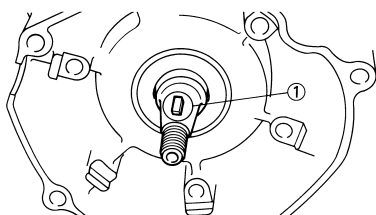

INSTALLING THE CDI MAGNETO

- Install:
 - Stator "1"
 - Screw (stator) "2"

TIP
Temporarily tighten the screws (stator) at this point.

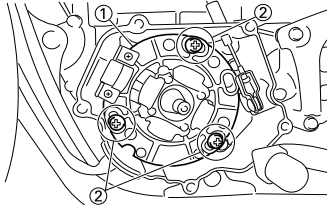

- Install:
 - Woodruff key "1"
 - Rotor "2"

TIP

- Clean the tapered portions of the crankshaft and rotor.
- When installing the woodruff key, make sure that its flat surface "a" is in parallel with the crankshaft center line "b".
- When installing the rotor, align the keyway "c" of the rotor with the woodruff key.

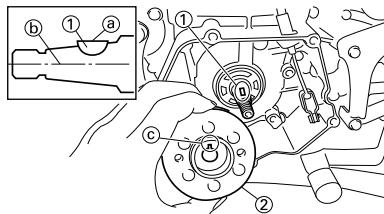

- Install:
 - Washer "1"
 - Nut (rotor) "2"



Nut (rotor):
56 Nm (5.6 m•kg, 40 ft•lb)

Use the rotor holding tool "3".



Rotor holding tool:
YU-01235/90890-01235

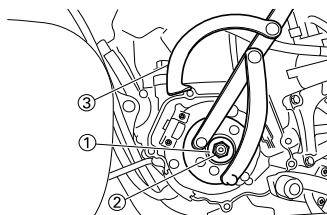

- Adjust:
 - Ignition timing
Refer to "CHECKING THE IGNITION TIMING" section in the CHAPTER 3.



Ignition timing (B.T.D.C):
0.18 mm (0.007 in)

- Tighten:
 - Screw (stator) "1"



Screw (stator):
7 Nm (0.7 m•kg, 5.1 ft•lb)

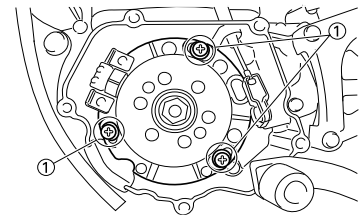

- Check:
 - Ignition timing
Re-check the ignition timing.
- Connect:
 - CDI magneto lead "1"
Refer to "CABLE ROUTING DIAGRAM" section in the CHAPTER 2.

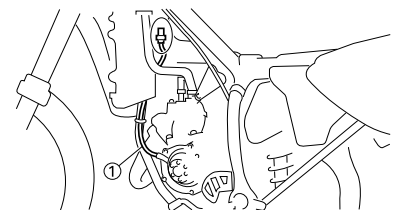

- Install:
 - Gasket (left crankcase cover)
 - New** Left crankcase cover "1"
 - Screw (left crankcase cover) "2"



Screw (left crankcase cover):
5 Nm (0.5 m•kg, 3.6 ft•lb)

TIP
Tighten the screws in stage, using a crisscross pattern.

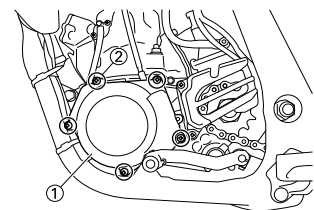

ENGINE REMOVAL

ENGINE REMOVAL REMOVING THE ENGINE

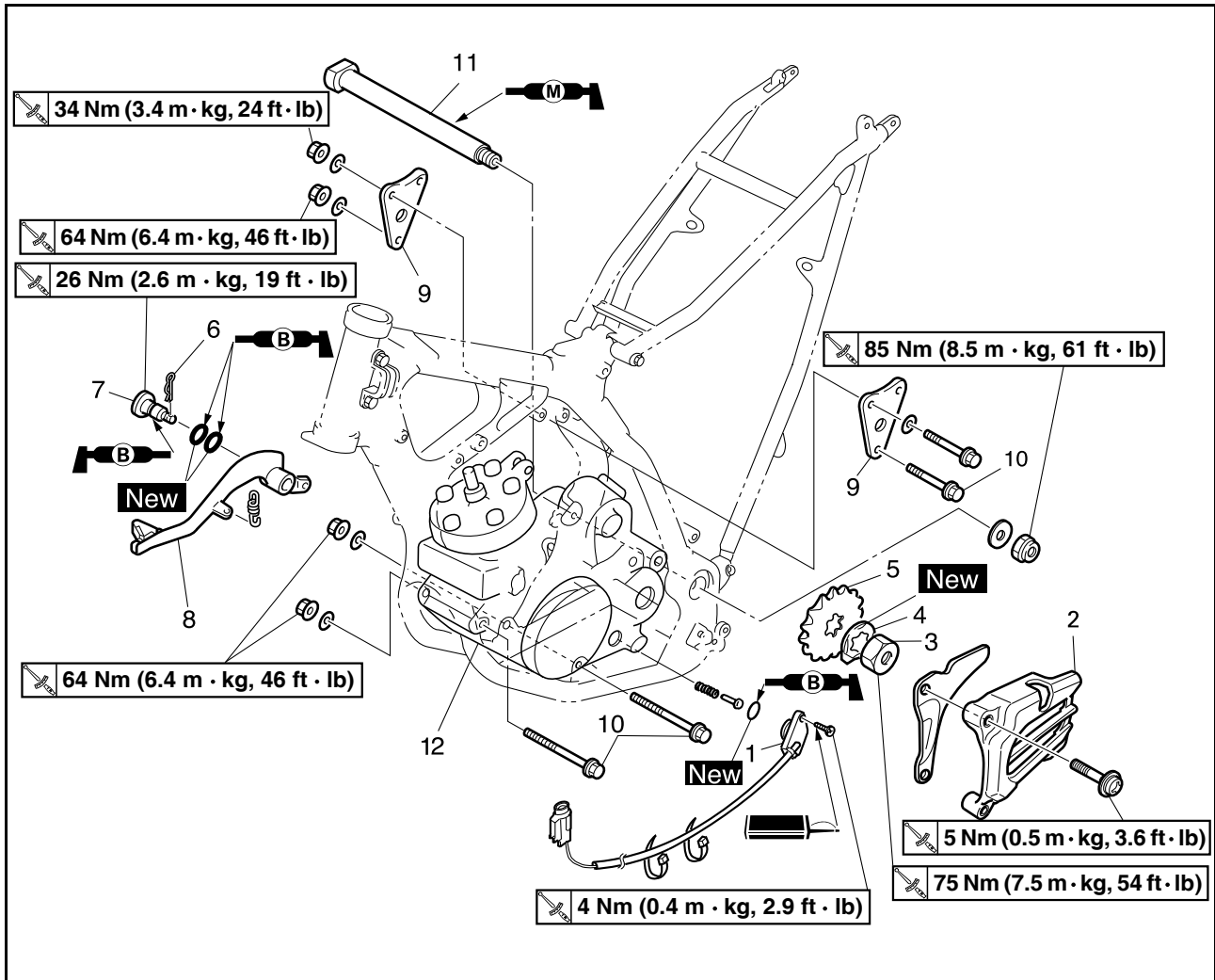

Order	Part name	Q'ty	Remarks
	Hold the machine by placing the suitable stand under the frame.		Refer to "HANDLING NOTE".
	Drain the transmission oil.		Refer to "CHANGING THE TRANSMISSION OIL" section in the CHAPTER 3.
	Seat and fuel tank		Refer to "SEAT, FUEL TANK AND SIDE COVERS" section
	Carburetor		Refer to "CARBURETOR AND REED VALVE" section.
	Exhaust pipe and silencer		Refer to "EXHAUST PIPE AND SILENCER" section.
	Exhaust pipe stay (rear)		Refer to "EXHAUST PIPE AND SILENCER" section.
	Clutch cable		Disconnect at engine side.
	Radiator		Refer to "RADIATOR" section.
	Spark plug		
	Disconnect the CDI magneto lead.		
1	Neutral switch	1	Disconnect the neutral switch lead.
2	Drive chain sprocket cover	1	

ENGINE REMOVAL

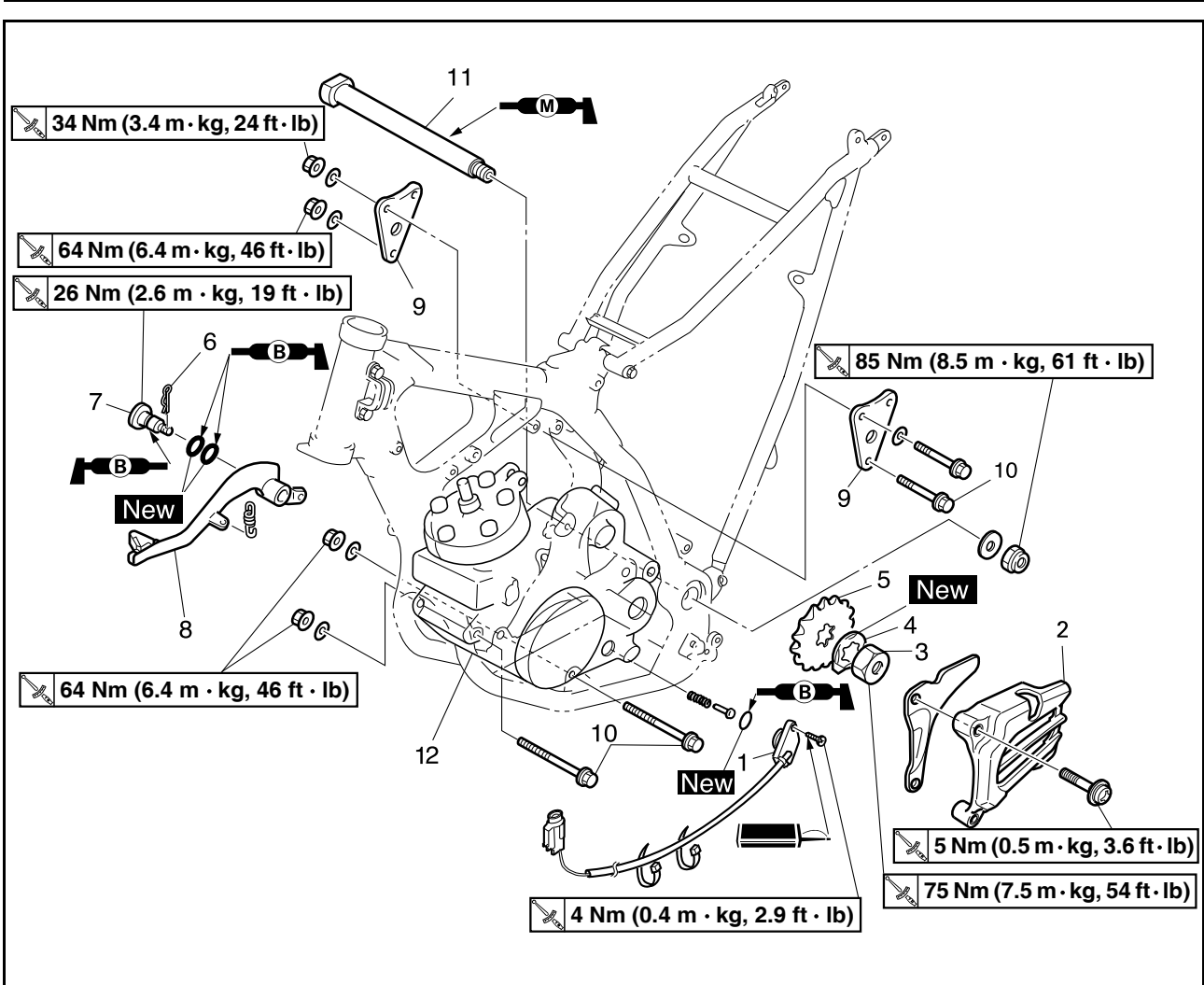

Order	Part name	Q'ty	Remarks
3	Nut (drive sprocket)	1	Refer to removal section.
4	Lock washer	1	Refer to removal section.
5	Drive sprocket	1	Refer to removal section.
6	Clip	1	
7	Bolt (brake pedal)	1	
8	Brake pedal	1	
9	Engine bracket	2	
10	Engine mounting bolt	3	
11	Pivot shaft	1	Remove completely.
12	Engine	1	Refer to removal section.

ENGINE REMOVAL

HANDLING NOTE

⚠ WARNING

Support the machine securely so there is no danger of it falling over.

REMOVING THE DRIVE SPROCKET

- Remove:
 - Nut (drive sprocket) "1"
 - Lock washer "2"

TIP

- Straighten the lock washer tab.
- Loosen the nut while applying the rear brake.

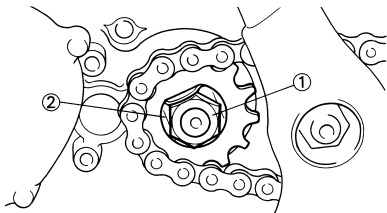

- Remove:
 - Drive sprocket "1"
 - Drive chain "2"

TIP

Remove the drive sprocket together with the drive chain.

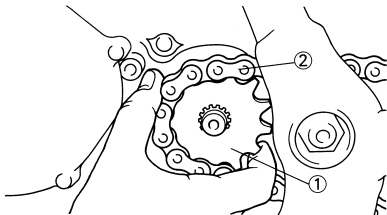

REMOVING THE ENGINE

TIP

Make sure that the couplers, hoses and cables are disconnected.

- Lift the engine "1" up to the point where the engine's mounting front does not contact the bracket on the frame.

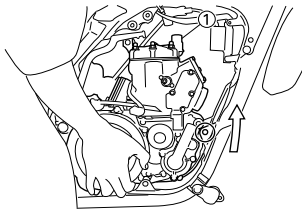

- Remove the engine "1" aslant and upward while inclining it toward the kick crank side so that the engine's mounting top does not contact the bracket on the frame.

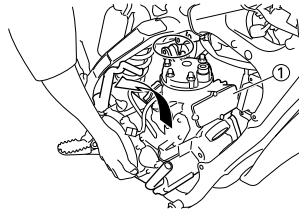

INSTALLING THE ENGINE

- Install:
 - Engine "1"
 - Install the engine from right side.
 - Pivot shaft "2"
 - Nut (pivot shaft) "3"

	Nut (pivot shaft): 85 Nm (8.5 m•kg, 61 ft•lb)
---	---

- Engine mounting bolt (lower) "4"
- Nut [engine mounting bolt (lower)] "5"

	Nut [engine mounting bolt (lower)]: 64Nm (6.4 m•kg, 46 ft•lb)
--	---

- Engine mounting bolt (front) "6"
- Nut [engine mounting bolt (front)] "7"

	Nut (engine mounting bolt (front)): 64 Nm (6.4 m•kg, 46 ft•lb)
---	--

- Engine bracket "8"
- Bolt (engine bracket) "9"
- Nut (engine bracket) "10"

	Nut (engine bracket): 34 Nm (3.4 m•kg, 24 ft•lb)
---	--

- Engine mounting bolt (upper) "11"
- Nut [engine mounting bolt (upper)] "12"

	Nut [engine mounting bolt (upper)]: 64 Nm (6.4 m•kg, 46 ft•lb)
---	--

TIP

Apply the molybdenum disulfide grease on the pivot shaft.

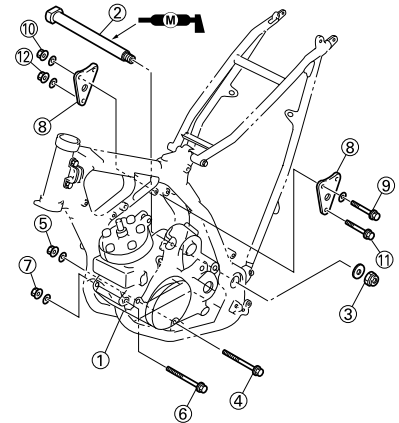

INSTALLING THE BRAKE PEDAL

- Install:
 - Spring "1"
 - Brake pedal "2"
 - O-ring "3" **New**
 - Bolt (brake pedal) "4"

	Bolt (brake pedal): 26 Nm (2.6 m•kg, 19 ft•lb)
---	--

- Clip "5"

TIP

Apply the lithium soap base grease on the bolt, O-rings and brake pedal bracket.

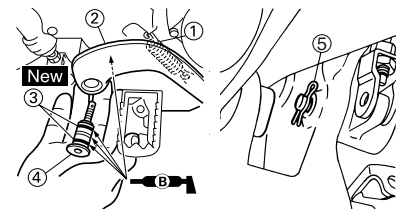

INSTALLING THE DRIVE SPROCKET

- Install:
 - Drive sprocket "1"
 - Drive chain "2"

TIP

Install the drive sprocket together with the drive chain.

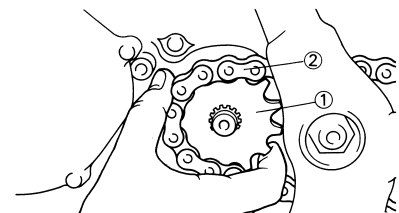

ENGINE REMOVAL

2. Install:

- Lock washer "1" **New**
- Nut (drive sprocket) "2"

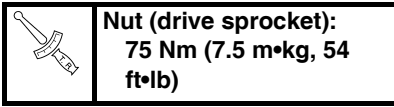

TIP

Tighten the nut while applying the rear brake.



3. Bend the lock washer tab to lock the nut.

4. Install:

- Drive chain sprocket guide "1"
- Drive chain sprocket cover "2"
- Screw (drive chain sprocket cover) "3"

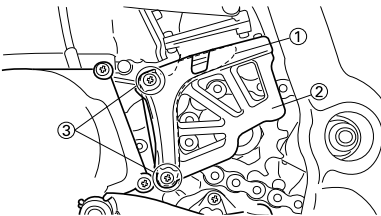
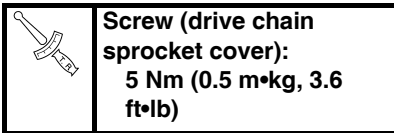

5. Connect:

- Neutral switch lead
Refer to "CABLE ROUTING DIAGRAM" section in the CHAPTER 2.

CRANKCASE AND CRANKSHAFT

CRANKCASE AND CRANKSHAFT

REMOVING THE CRANKSHAFT

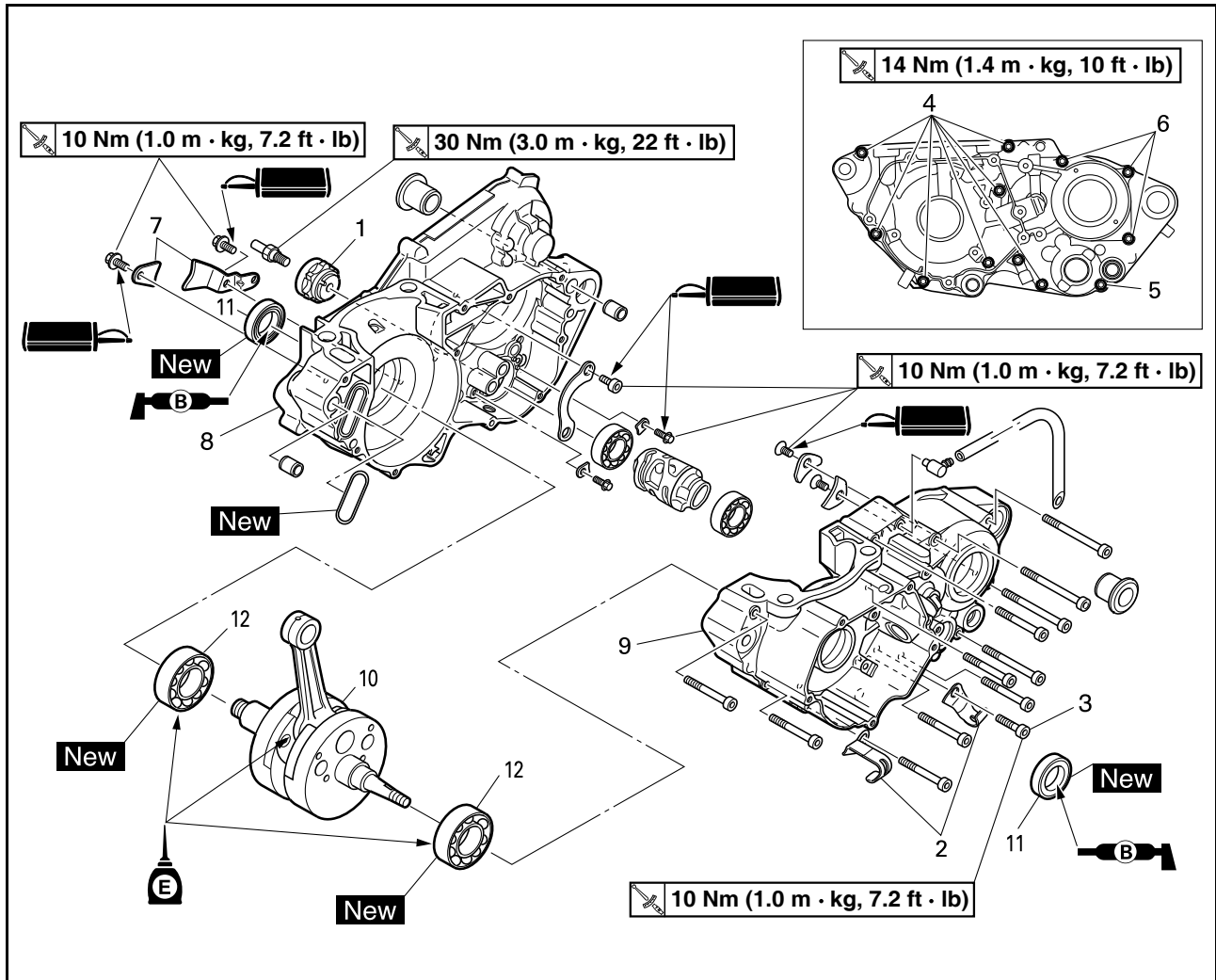

Order	Part name	Q'ty	Remarks
	Engine		Refer to "ENGINE REMOVAL" section.
	Piston		Refer to "CYLINDER HEAD, CYLINDER AND PISTON" section.
	Primary drive gear		Refer to "KICK SHAFT AND SHIFT SHAFT" section.
	Kick idle gear		Refer to "KICK SHAFT AND SHIFT SHAFT" section.
	Stopper lever		Refer to "KICK SHAFT AND SHIFT SHAFT" section.
	Rotor and stator		Refer to "CDI MAGNETO" section.
1	Segment	1	Refer to removal section.
2	Holder	2	
3	Bolt (Neutral switch lead holder)	1	
4	Bolt [L=50 mm (1.97 in)]	7	
5	Bolt [L=60 mm (2.36 in)]	1	
6	Bolt [L=70 mm (2.76 in)]	3	
7	Holder	2	
8	Crankcase (right)	1	Refer to removal section.

CRANKCASE AND CRANKSHAFT

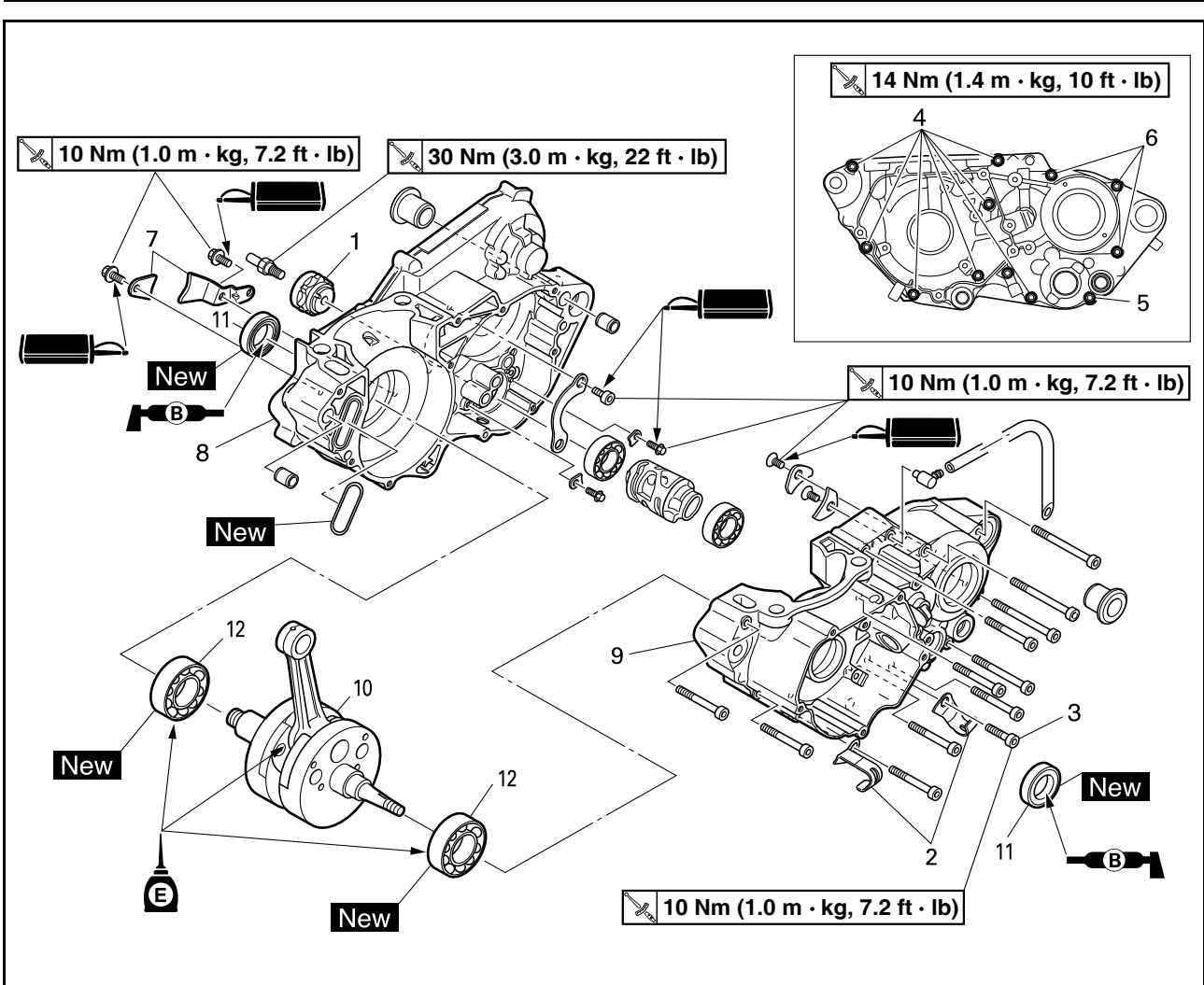

Order	Part name	Q'ty	Remarks
9	Crankcase (left)	1	Refer to removal section.
10	Crankshaft	1	Refer to removal section.
11	Oil seal	2	
12	Bearing	2	Refer to removal section.

CRANKCASE AND CRANKSHAFT

REMOVING THE SEGMENT

- Remove:
 - Bolt (segment) "1"
 - Segment "2"

TIP

Turn the segment counterclockwise until it stops and loosen the bolt.

NOTICE

If the segment gets an impact, the stopper lever may be damaged. Take care not to give an impact to it when removing the bolt.

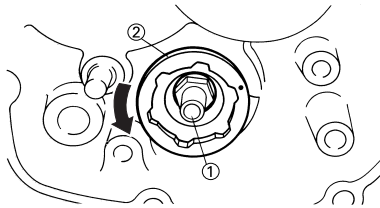

DISASSEMBLING THE CRANKCASE

- Remove:
 - Crankcase (right) "1"
 Use the crankcase separating tool "2".

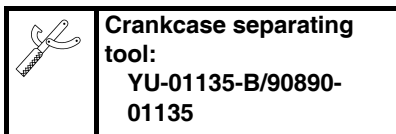

TIP

- Make appropriate bolts "3" as shown available by yourself and attach the tool with them.
- Fully tighten the tool holding bolts, but make sure the tool body is parallel with the case. If necessary, one screw may be backed out slightly to level tool body.
- As pressure is applied, alternately tap on the engine mounting boss and transmission shafts.

NOTICE

Use soft hammer to tap on the case half. Tap only on reinforced portions of case. Do not tap on gasket mating surface. Work slowly and carefully. Make sure the case halves separate evenly. If one end "hangs up", take pressure off the push screw, realign, and start over. If the cases do not separate, check for a remaining case bolt or fitting. Do not force.

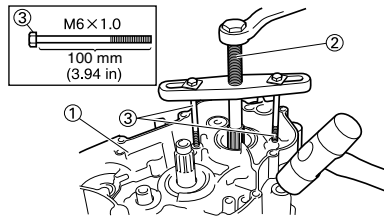

REMOVING THE CRANKSHAFT

- Remove:
 - Crankshaft "1"
 Use the crankcase separating tool "2".

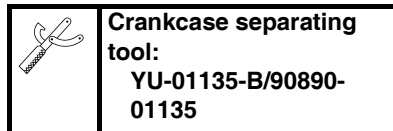

TIP

Make appropriate bolts "3" as shown available by yourself and attach the tool with them.

NOTICE

Do not use a hammer to drive out the crankshaft.

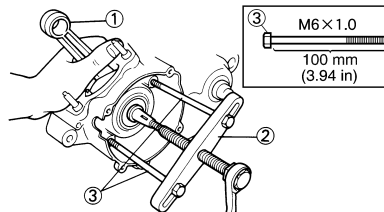

REMOVING THE CRANKCASE BEARING

- Remove:
 - Bearing "1"
- TIP**
- Remove the bearing from the crankcase by pressing its inner race as shown in "A".
 - If the bearing is removed together with the crankshaft, remove the bearing using a general bearing puller "2" as shown in "B".
 - Do not use the removed bearing.

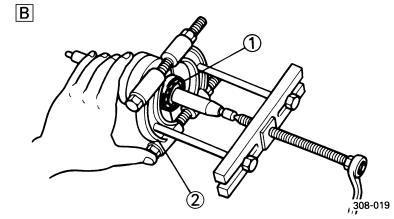
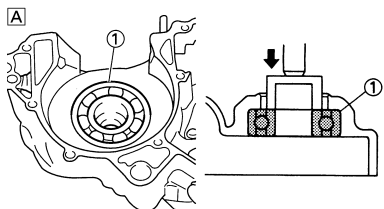

CHECKING THE CRANKCASE

- Inspect:
 - Contacting surface "a"
Scratches → Replace.
 - Engine mounting boss "b", crankcase
Cracks/damage → Replace.

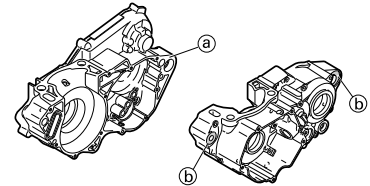

- Inspect:
 - Bearing "1"
Rotate inner race with a finger.
Rough spot/seizure → Replace.

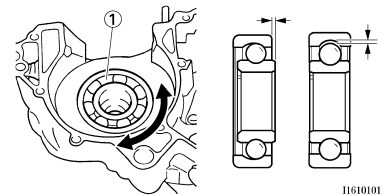

- Inspect:
 - Oil seal "1"
Damage → Replace.

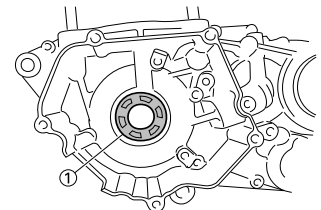

CHECKING THE CRANKSHAFT

- Measure:
 - Runout limit "a"
 - Small end free play limit "b"
 - Connecting rod big end side clearance "c"
 - Crank width "d"
 Out of specification → Replace.
Use the dial gauge and a thickness gauge.

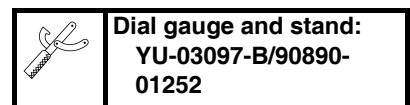

CRANKCASE AND CRANKSHAFT

	Standard	<Limit>
Runout limit:	0.030 mm (0.0012 in)	0.050 mm (0.0020 in)
Small end free play:	0.40–1.00 mm (0.02–0.04 in)	2.0 mm (0.08 in)
Side clearance:	0.250–0.750 mm (0.0098–0.0295 in)	—
Crack width:	59.95–60.00 mm (2.360–2.362 in)	—

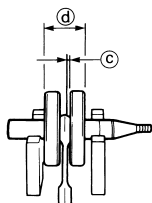
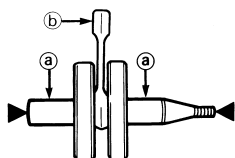

INSTALLING THE CRANKCASE BEARING

- Install:
 - Bearing "1" **New**
 To left and right crankcase.

TIP

- Apply the engine oil on the bearing.
- Install the bearing by pressing its outer race parallel.

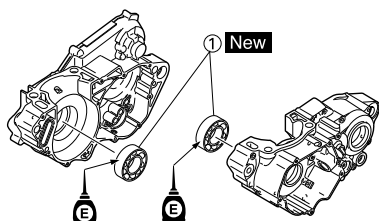

INSTALLING THE OIL SEAL

- Install:
 - Oil seal (left) "1" **New**
 - Oil seal (right) "2" **New**

TIP

- Apply the lithium soap base grease on the oil seal lip.
- Install the oil seal with its manufacturer's marks or numbers facing outward.

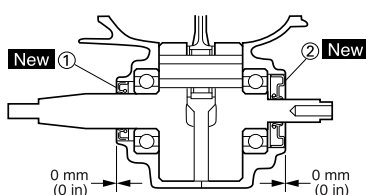

INSTALLING THE CRANKSHAFT

- Install:
 - Crankshaft "1"
 Use the crankshaft installing tools "2", "3", "4".



Crankshaft installing pot "2":
YU-90058/90890-01274

Crankshaft installing bolt "3":
YU-90060/90890-01275

Adapter "4":
YU-90063/90890-01278

TIP

- Hold the connecting rod at top dead center with one hand while turning the nut of the installing tool with the other. Operate the installing tool until the crankshaft bottoms against the bearing.
- Before installing the crankshaft, clean the contacting surface of crankcase.
- Apply the lithium soap base grease on the oil seal lip.

NOTICE

Do not use a hammer to drive in the crankshaft.

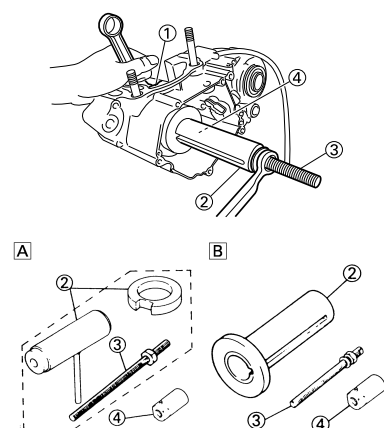

- For USA and CDN
- Except for USA and CDN

- Check:
 - Shifter operation
 - Transmission operation
 - Unsmooth operation → Repair.

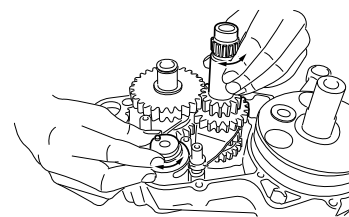

- Install:
 - O-ring "1" **New**
 To right crankcase "2".

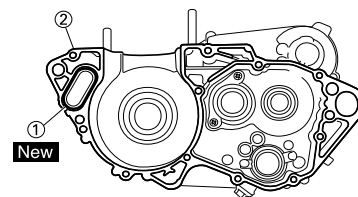

- Apply:
 - Sealant
 On the right crankcase "1"



Yamaha bond No.1215:
90890-85505
(Three bond No.1215®)

TIP

Clean the contacting surface of left and right crankcase before applying the sealant.

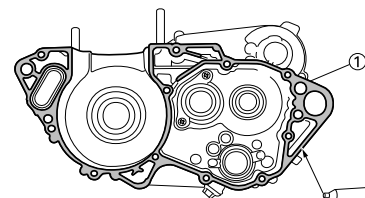

- Install:
 - Dowel pin "1"
 - Right crankcase "2"
 To right crankcase "3".

TIP

- Fit the right crankcase onto the left crankcase. Tap lightly on the case with soft hammer.
- When installing the crankcase, the connecting rod should be positioned at TDC (top dead center).

NOTICE

In order to prevent the oil seal lip "a" from being turned up or damaged, wrap a vinyl tape or the like "b" around the right end of the crankshaft and apply the lithium soap base grease over the tape.

CRANKCASE AND CRANKSHAFT

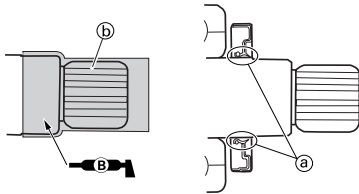
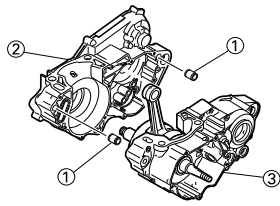

6. Install:

- Holder "1"
- Bolt (holder) "2"

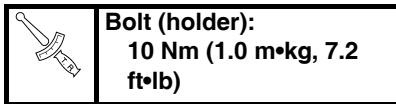

- Bolt (crankcase)

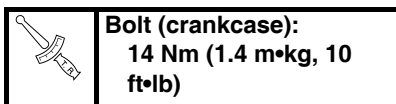

TIP

Tighten the crankcase tightening bolts in stage, using a crisscross pattern.

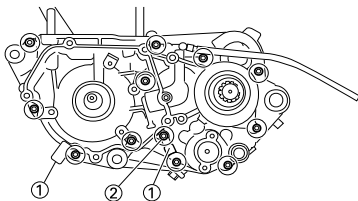

7. Install:

- Tension spring "1"
- Holder "2"
- Bolt (holder) "3" 

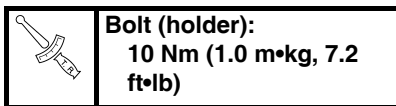

TIP

Install the holder so that it contacts the projection "a" on the right crankcase.

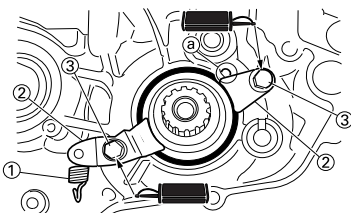

8. Install:

- Segment "1"
- Bolt (segment) "2"

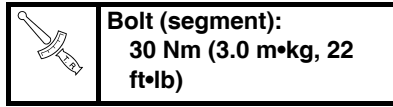

TIP

- When installing the segment onto the shift cam "3", align the punch mark "a" with the dowel pin "b".
- Turn the segment clockwise until it stops and tighten the bolt.

NOTICE

If the segment gets an impact, the stopper lever may be damaged. Take care not to give an impact to it when tightening the bolt.

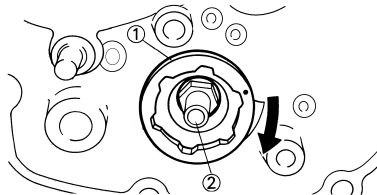
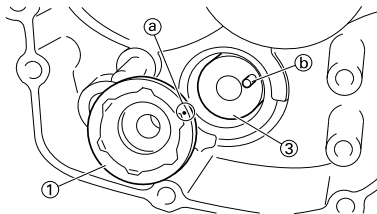

9. Remove:

- Sealant
Forced out on the cylinder mating surface.

10. Apply:

- Engine oil
To the crank pin, bearing, oil delivery hole and connecting rod big end washer.

11. Check:

- Crankshaft and transmission operation.
Unsmooth operation → Repair.

TRANSMISSION, SHIFT CAM AND SHIFT FORK

TRANSMISSION, SHIFT CAM AND SHIFT FORK

REMOVING THE TRANSMISSION, SHIFT CAM AND SHIFT FORK

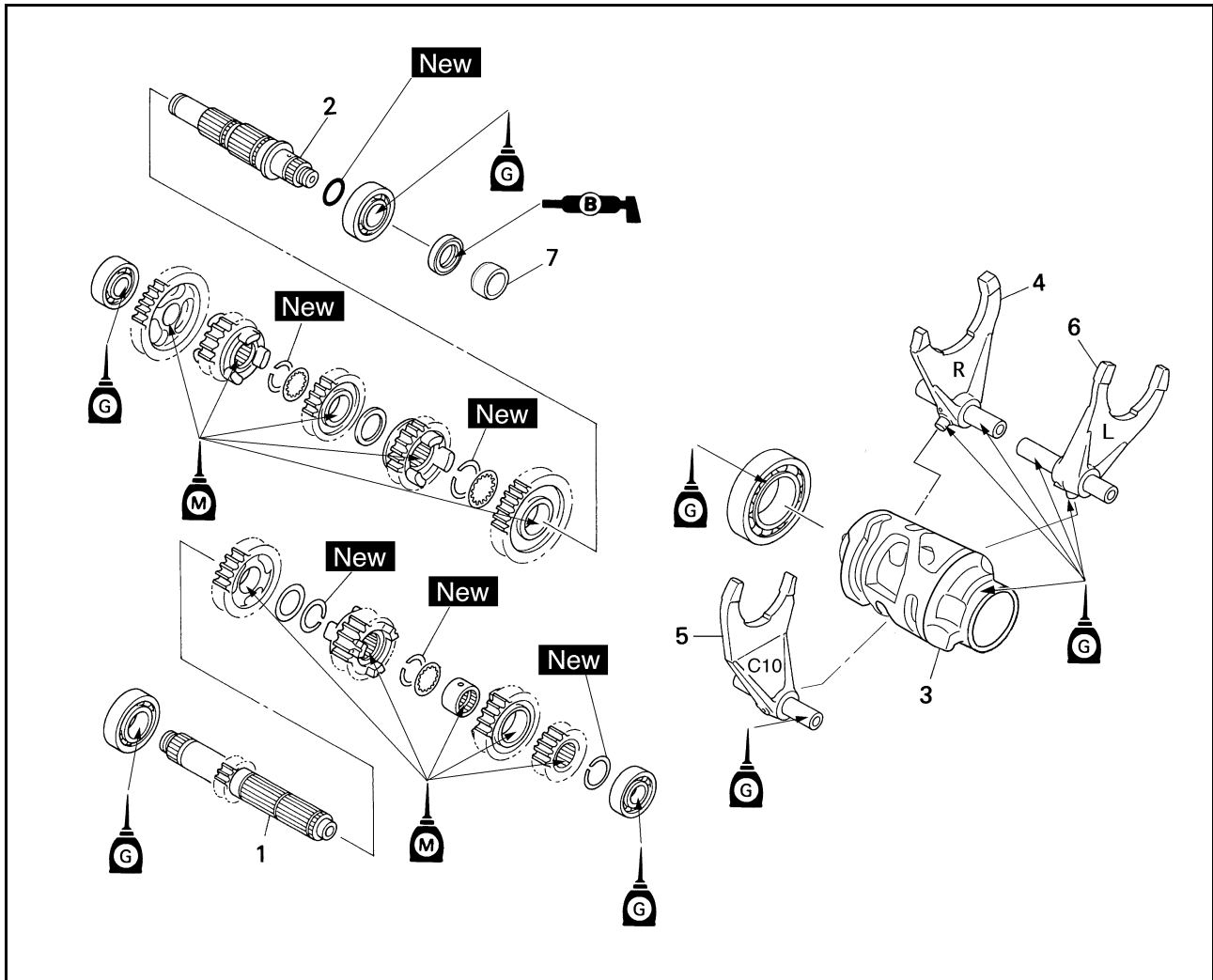

Order	Part name	Q'ty	Remarks
	Engine		Refer to "ENGINE REMOVAL" section.
	Separate the crankcase.		Refer to "CRANKCASE AND CRANK-SHAFT" section.
1	Main axle	1	Refer to removal section.
2	Drive axle	1	Refer to removal section.
3	Shift cam	1	Refer to removal section.
4	Shift fork 3	1	Refer to removal section.
5	Shift fork 2	1	Refer to removal section.
6	Shift fork 1	1	Refer to removal section.
7	Collar	1	

TRANSMISSION, SHIFT CAM AND SHIFT FORK

REMOVING THE TRANSMISSION

- Remove:
 - Main axle "1"
 - Drive axle "2"
 - Shift cam
 - Shift fork 3
 - Shift fork 2
 - Shift fork 1

TIP

- Remove assembly carefully. Note the position of each part. Pay particular attention to the location and direction of shift forks.
- Remove the main axle, drive axle, shift cam and shift fork all together by tapping lightly on the transmission drive axle with a soft hammer.

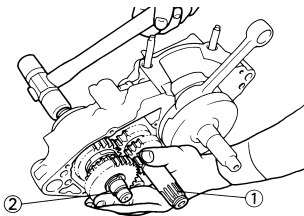

CHECKING THE GEARS

- Inspect:
 - Matching dog "a"
 - Gear teeth "b"
 - Shift fork groove "c"
 Wear/damage → Replace.

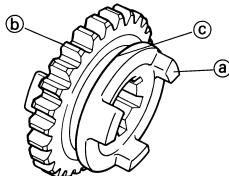

- Inspect:
 - O-ring "1"
 Damage → Replace.

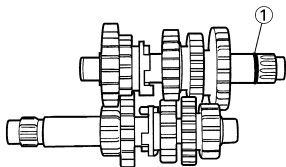

- Check:
 - Gears movement
 Unsmooth movement → Repair or replace.

CHECKING THE BEARING

- Inspect:
 - Bearing "1"
 Rotate inner race with a finger.
 Rough spot/seizure → Replace.

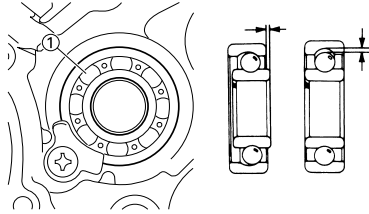

CHECKING THE SHIFT FORK, SHIFT CAM AND SEGMENT

- Inspect:
 - Shift fork "1"
 Wear/damage/scratches → Replace.

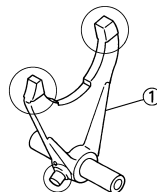

- Inspect:
 - Shift cam "1"
 - Segment "2"
 Wear/damage → Replace.

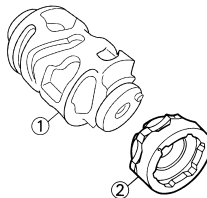

- Check:
 - Shift fork movement
 Unsmooth operation → Replace shift fork.

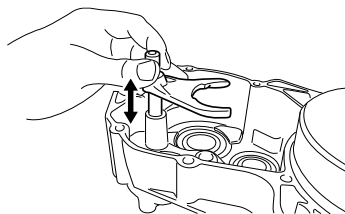

TIP

For a malfunctioning shift fork, replace not only the shift fork itself but the two gears each adjacent to the shift fork.

INSTALLING THE TRANSMISSION

- Install:
 - 5th pinion gear (21T) "1"
 - 3rd pinion gear (18T) "2"
 - Collar "3"
 - 4th pinion gear (22T) "4"
 - 2nd pinion gear (15T) "5"
 To main axle "6".

TIP

Apply the molybdenum disulfide oil on the inner and end surface of the idler gear and on the inner surface of the sliding gear, then install.

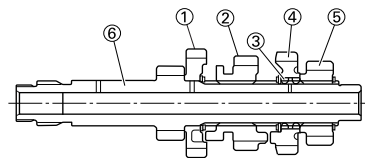
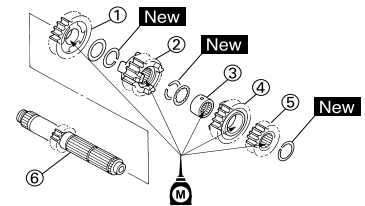

- Install:
 - 2nd wheel gear (23T) "1"
 - 4th wheel gear (24T) "2"
 - 3rd wheel gear (23T) "3"
 - 5th wheel gear (20T) "4"
 - 1st wheel gear (27T) "5"
 - O-ring "6" **New**
 To drive axle "7".

TIP

- Apply the molybdenum disulfide oil on the inner and end surface of the idler gear and on the inner surface of the sliding gear, then install.
- Apply the lithium soap base grease on the O-ring.

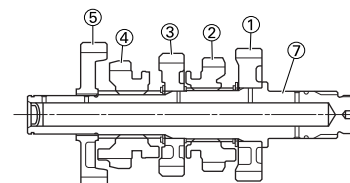
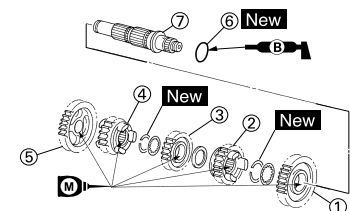

TRANSMISSION, SHIFT CAM AND SHIFT FORK

3. Install:

- Washer "1"
- Circlip "2" **New**

TIP

- Be sure the circlip sharp-edged corner "a" is positioned opposite side to the washer and gear "b".
- Be sure the circlip end "c" is positioned at axle spline groove "d".

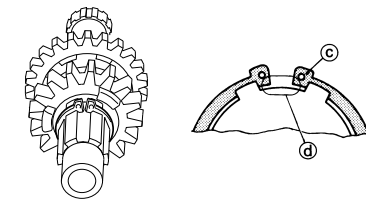
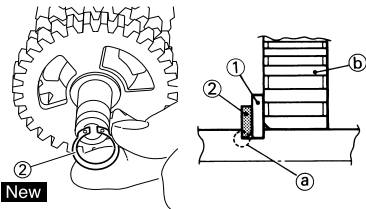

4. Install:

- Collar "1"

TIP

- Apply the lithium soap base grease on the oil seal lip.
- When installing the collar into the crankcase, pay careful attention to the crankcase oil seal lip.
- Install the spacer with its chamfered side "a" facing the crankcase.

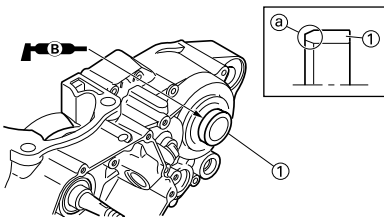

5. Install:

- Shift fork 1 (L) "1"
 - Shift fork 2 (C10) "2"
 - Shift fork 3 (R) "3"
 - Shift cam "4"
- To main axle and drive axle.

TIP

- Apply the molybdenum disulfide oil on the shift fork grooves.
- Mesh the shift fork 1 (L) with the 4th wheel gear "5" and 3 (R) with the 5th wheel gear "7" on the drive axle.
- Mesh the shift fork 2 (C10) with the 3rd pinion gear "6" on the main axle.

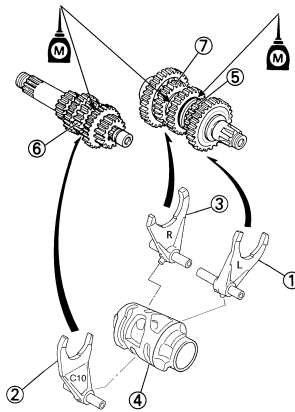

6. Install:

- Transmission assembly "1"
- To left crankcase "2".

TIP

Apply the transmission oil on the bearings and guide bars.

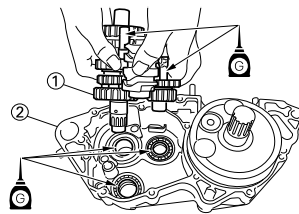

7. Check:

- Shifter operation
 - Transmission operation
- Unsmooth operation → Repair.

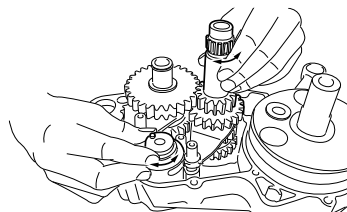

FRONT WHEEL AND REAR WHEEL

CHASSIS

TIP

This section is intended for those who have basic knowledge and skill concerning the servicing of Yamaha motorcycles (e.g., Yamaha dealers, service engineers, etc.). Those who have little knowledge and skill concerning servicing are requested not to undertake inspection, adjustment, disassembly, or reassembly only by reference to this manual. It may lead to servicing trouble and mechanical damage.

FRONT WHEEL AND REAR WHEEL

REMOVING THE FRONT WHEEL

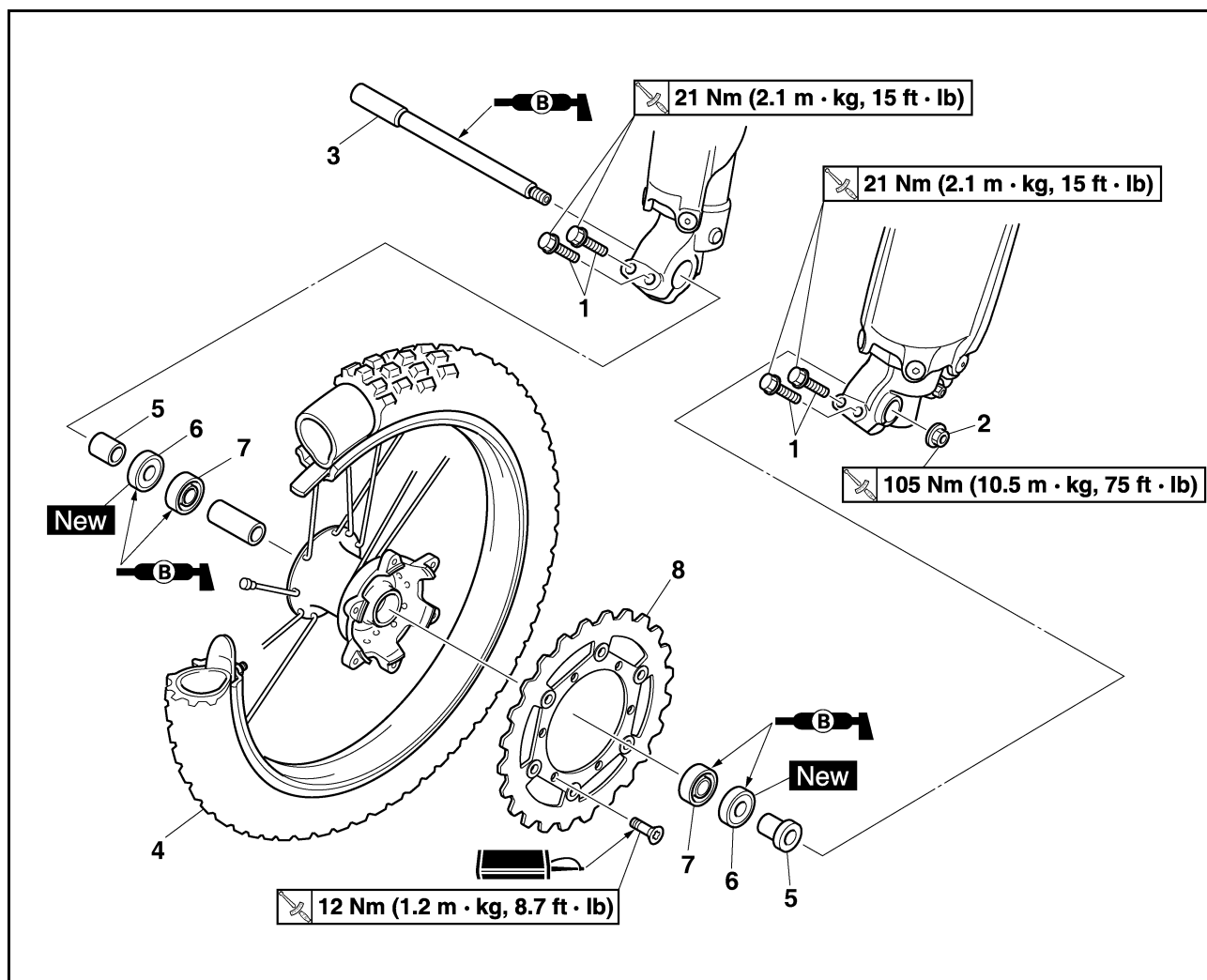

Order	Part name	Q'ty	Remarks
	Hold the machine by placing the suitable stand under the engine.		Refer to "HANDLING NOTE".
1	Bolt (axle holder)	4	Only loosening.
2	Nut (front wheel axle)	1	
3	Front wheel axle	1	
4	Front wheel	1	
5	Collar	2	
6	Oil seal	2	
7	Bearing	2	Refer to removal section.
8	Brake disc	1	

FRONT WHEEL AND REAR WHEEL

REMOVING THE REAR WHEEL

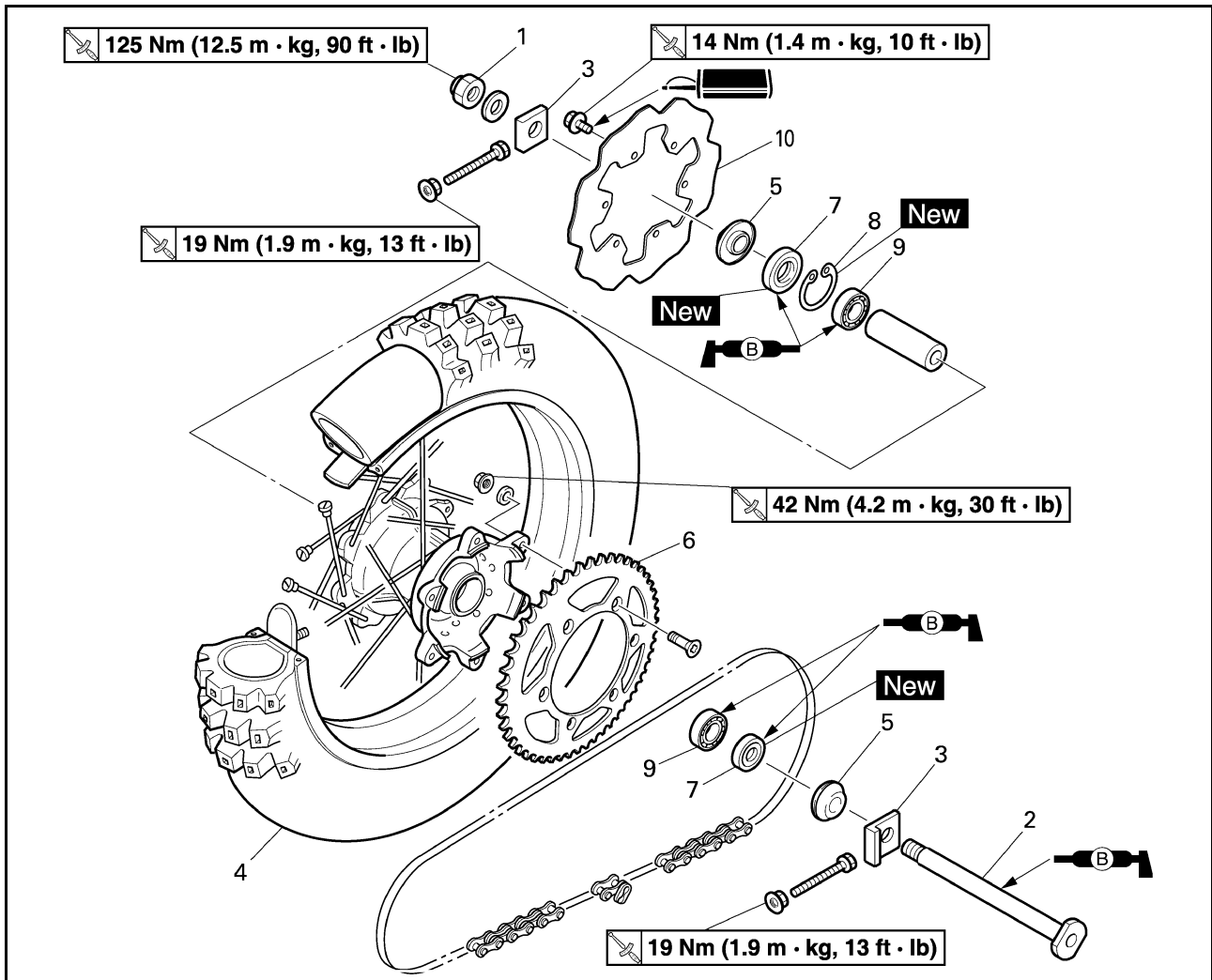

Order	Part name	Q'ty	Remarks
	Hold the machine by placing the suitable stand under the engine.		Refer to "HANDLING NOTE".
1	Nut (rear wheel axle)	1	
2	Rear wheel axle	1	
3	Drive chain puller	2	
4	Rear wheel	1	Refer to removal section.
5	Collar	2	
6	Rear wheel sprocket	1	
7	Oil seal	2	
8	Circlip	1	
9	Bearing	2	Refer to removal section.
10	Brake disc	1	

FRONT WHEEL AND REAR WHEEL

HANDLING NOTE

⚠ WARNING

Support the machine securely so there is no danger of it falling over.

REMOVING THE REAR WHEEL

- Remove:
 - Wheel "1"

TIP

Push the wheel forward and remove the drive chain "2".

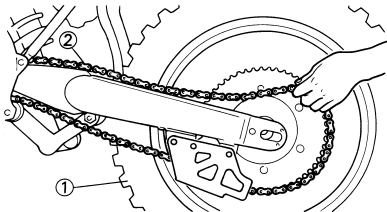

REMOVING THE WHEEL BEARING

- Remove:
 - Bearing "1"

TIP

Remove the bearing using a general bearing puller "2".

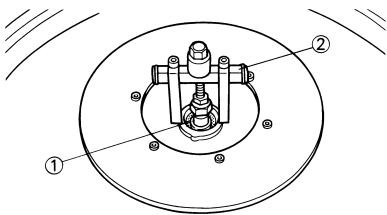

CHECKING THE WHEEL

- Measure:
 - Wheel runout
 - Out of specification → Repair/replace.

	Wheel runout limit:
	Radial "1": 2.0 mm (0.08 in) Lateral "2": 2.0 mm (0.08 in)

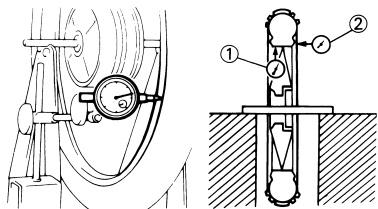

- Inspect:
 - Bearing
 - Rotate inner race with a finger.
 - Rough spot/seizure → Replace.

TIP

Replace the bearings, oil seal and wheel collar as a set.

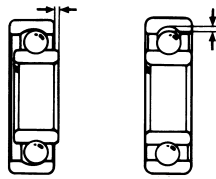

CHECKING THE WHEEL AXLE

- Measure:
 - Wheel axle bends
 - Out of specification → Replace.
 - Use the dial gauge "1".

	Wheel axle bending limit:
	0.50 mm (0.02 in)

TIP

The bending value is shown by one half of the dial gauge reading.

⚠ WARNING

Do not attempt to straighten a bent axle.

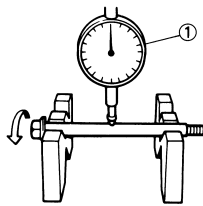

CHECKING THE BRAKE DISC

- Measure:
 - Brake disc deflection (only rear brake disc)
 - Use the dial gauge "1".
 - Out of specification → Inspect wheel runout.
 - If wheel runout is in good condition, replace the brake disc.

	Brake disc deflection limit:
	Rear: <Limit>: 0.15 mm (0.0059 in)

- Measure:
 - Brake disc thickness "a"
 - Out of specification → Replace.

	Brake disc thickness "a":
	Front: 3.0 mm (0.12 in) <Limit>: 2.5 mm (0.10 in) Rear: 4.0 mm (0.16 in) <Limit>: 3.5 mm (0.14 in)

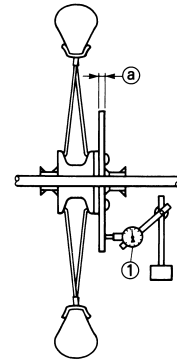

INSTALLING THE FRONT WHEEL

- Install:
 - Bearing (left) "1"
 - Spacer "2"
 - Bearing (right) "3"
 - Oil seal "4" **New**

TIP

- Apply the lithium soap base grease on the bearing and oil seal lip when installing.
- Use a socket that matches the outside diameter of the race of the bearing.
- Left side of bearing shall be installed first.
- Install the oil seal with its manufacturer's marks or numbers facing outward.

NOTICE

Do not strike the inner race of the bearing. Contact should be made only with the outer race.

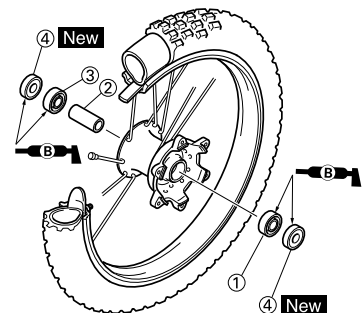

FRONT WHEEL AND REAR WHEEL

2. Install:

- Brake disc "1"
- Bolt (brake disc) "2"

	Bolt (brake disc): 12 Nm (1.2 m•kg, 8.7 ft•lb)
---	--

TIP

Tighten the bolts in stage, using a crisscross pattern.

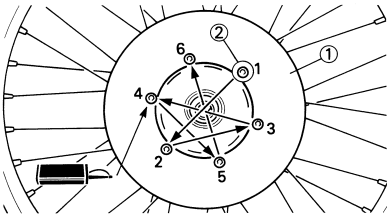

3. Install:

- Collar "1"

TIP

- Apply the lithium soap base grease on the oil seal lip.
- Install the collars with their projections "a" facing the wheel.

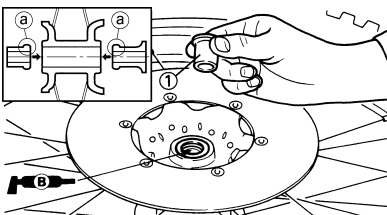

4. Install:

- Wheel

TIP

Install the brake disc "1" between the brake pads "2" correctly.

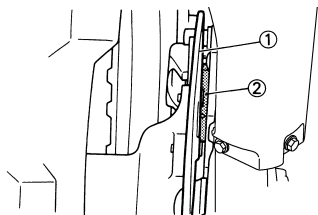

5. Install:

- Wheel axle "1"

TIP

Apply the lithium soap base grease on the wheel axle.

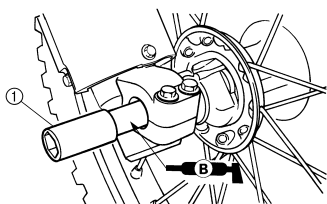

6. Install:

- Nut (wheel axle) "1"

	Nut (wheel axle): 105 Nm (10.5 m•kg, 75 ft•lb)
---	--

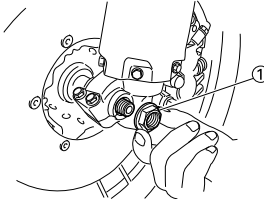

7. Tighten:

- Bolt (axle holder) "1"

	Bolt (axle holder): 21 Nm (2.1 m•kg, 15 ft•lb)
---	--

TIP

Before tightening the bolt, fit the wheel axle to the axle holder by stroking the front fork several times with the front brake applied.

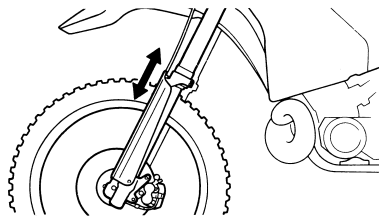
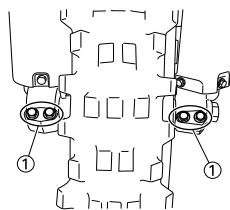

INSTALLING THE REAR WHEEL

1. Install:

- Bearing (right) "1"
- Circlip "2" **New**
- Spacer "3"
- Bearing (left) "4"
- Oil seal "5" **New**

TIP

- Apply the lithium soap base grease on the bearing and oil seal lip when installing.
- Install the bearing with seal facing outward.
- Use a socket that matches the outside diameter of the race of the bearing.
- Right side of bearing shall be installed first.
- Install the oil seal with its manufacturer's marks or numbers facing outward.

NOTICE

Do not strike the inner race of the bearing. Contact should be made only with the outer race.

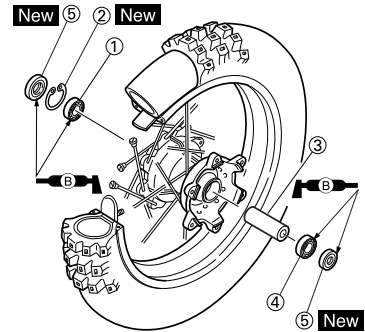

2. Install:

- Brake disc "1"
- Bolt (brake disc) "2"

	Bolt (brake disc): 14 Nm (1.4 m•kg, 10 ft•lb)
--	---

TIP

Tighten the bolts in stage, using a crisscross pattern.

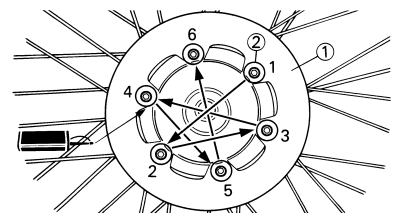

3. Install:

- Rear wheel sprocket "1"
- Bolt (rear wheel sprocket) "2"
- Washer (rear wheel sprocket) "3"
- Nut (rear wheel sprocket) "4"

	Nut (rear wheel sprocket): 42 Nm (4.2 m•kg, 30 ft•lb)
---	---

TIP

Tighten the nuts in stage, using a crisscross pattern.

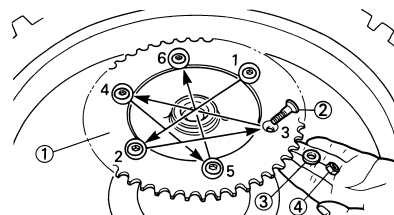

FRONT WHEEL AND REAR WHEEL

4. Install:

- Collar "1"

TIP

Apply the lithium soap base grease on the oil seal lip.

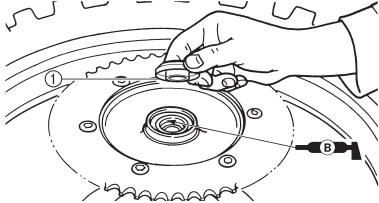

5. Install:

- Wheel

TIP

Install the brake disc "1" between the brake pads "2" correctly.

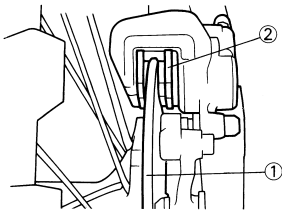

6. Install:

- Drive chain "1"

TIP

Push the wheel "2" forward and install the drive chain.

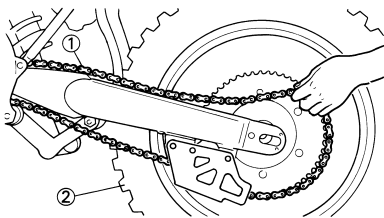

7. Install:

- Left drive chain puller "1"
- Wheel axle "2"

TIP

- Install the left drive chain puller, and insert the wheel axle from left side.
- Apply the lithium soap base grease on the wheel axle.

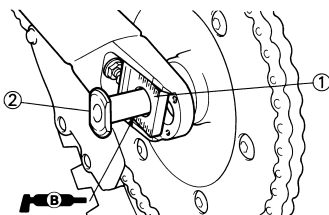

8. Install:

- Right drive chain puller "1"
- Washer "2"
- Nut (wheel axle) "3"

TIP

Temporarily tighten the nut (wheel axle) at this point.

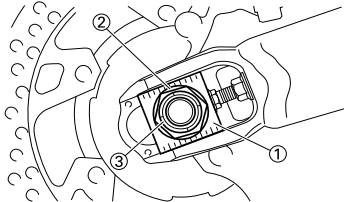

9. Adjust:

- Drive chain slack "a"



Drive chain slack "a":
48.0–58.0 mm (1.89–2.28 in)

Refer to "ADJUSTING THE DRIVE CHAIN SLACK" section in the CHAPTER 3.

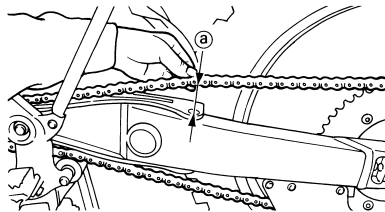

10. Tighten:

- Nut (wheel axle) "1"



Nut (wheel axle):
125 Nm (12.5 m•kg, 90 ft•lb)

- Locknut "2"



Locknut:
19 Nm (1.9 m•kg, 13 ft•lb)

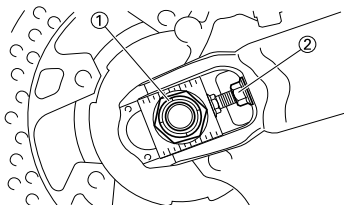

FRONT BRAKE AND REAR BRAKE

FRONT BRAKE AND REAR BRAKE REMOVING THE FRONT BRAKE

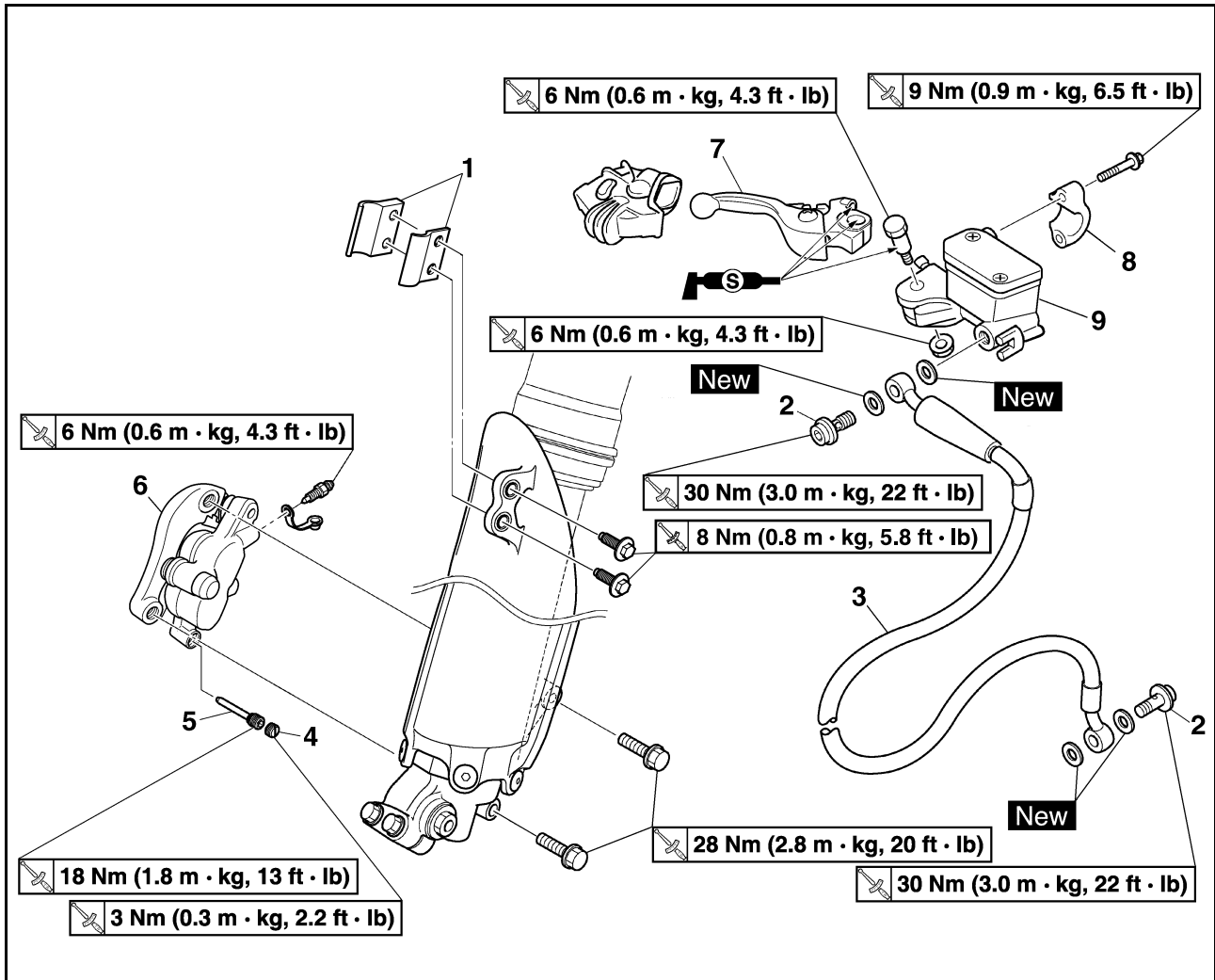

Order	Part name	Q'ty	Remarks
	Hold the machine by placing the suitable stand under the engine.		Refer to "HANDLING NOTE".
	Drain the brake fluid.		Refer to removal section.
1	Brake hose holder (protector)	2	
2	Union bolt	2	
3	Brake hose	1	
4	Pad pin plug	1	Remove when loosening the pad pin.
5	Pad pin	1	Loosen when disassembling the brake caliper.
6	Brake caliper	1	
7	Brake lever	1	
8	Brake master cylinder bracket	1	
9	Brake master cylinder	1	

FRONT BRAKE AND REAR BRAKE

REMOVING THE REAR BRAKE

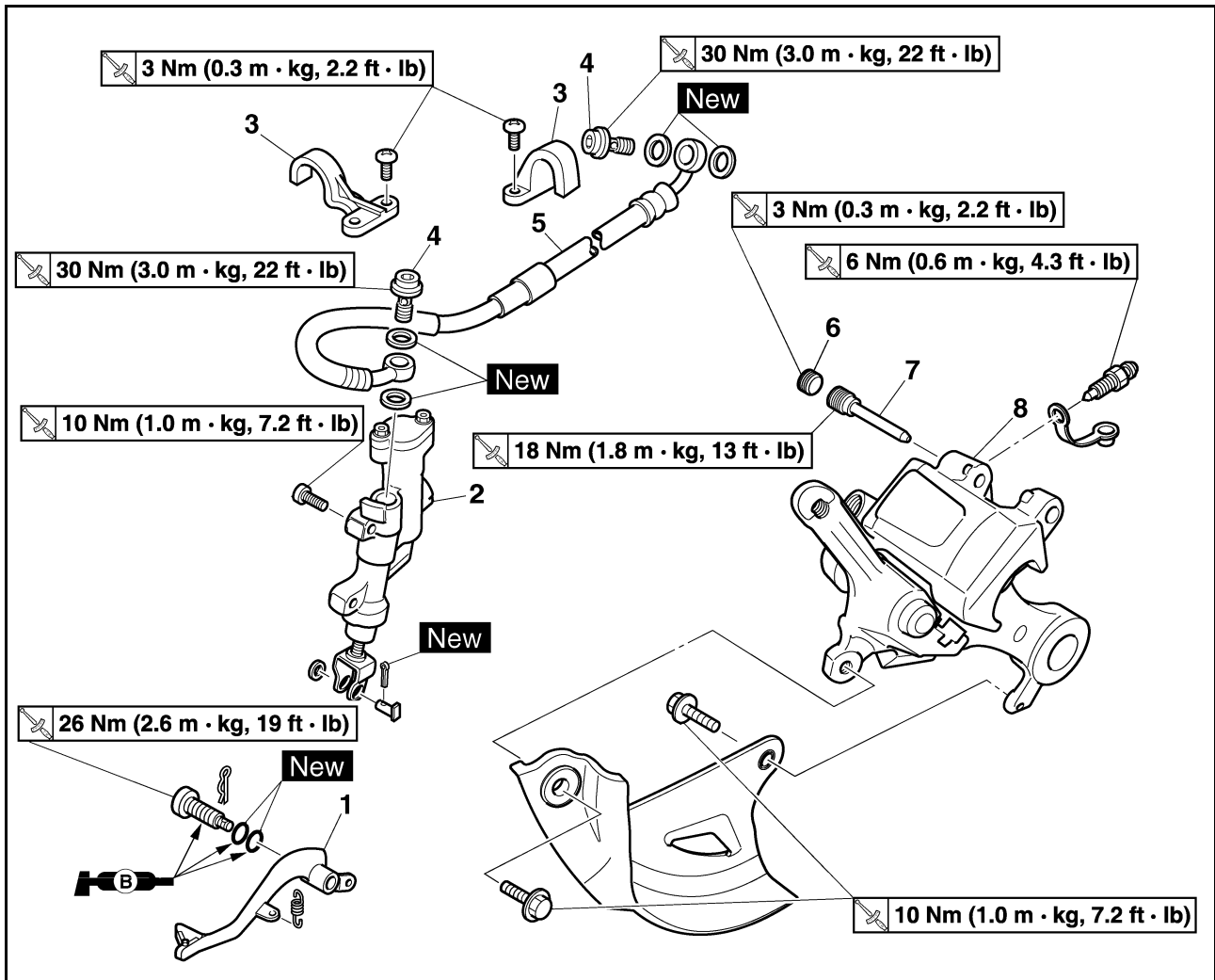

Order	Part name	Q'ty	Remarks
	Hold the machine by placing the suitable stand under the engine.		Refer to "HANDLING NOTE".
	Rear wheel		Refer to "FRONT WHEEL AND REAR WHEEL" section.
	Drain the brake fluid.		Refer to removal section.
1	Brake pedal	1	
2	Brake master cylinder	1	
3	Brake hose holder	2	
4	Union bolt	2	
5	Brake hose	1	
6	Pad pin plug	1	Remove when loosening the pad pin.
7	Pad pin	1	Loosen when disassembling the brake caliper.
8	Brake caliper	1	

FRONT BRAKE AND REAR BRAKE

DISASSEMBLING THE BRAKE CALIPER

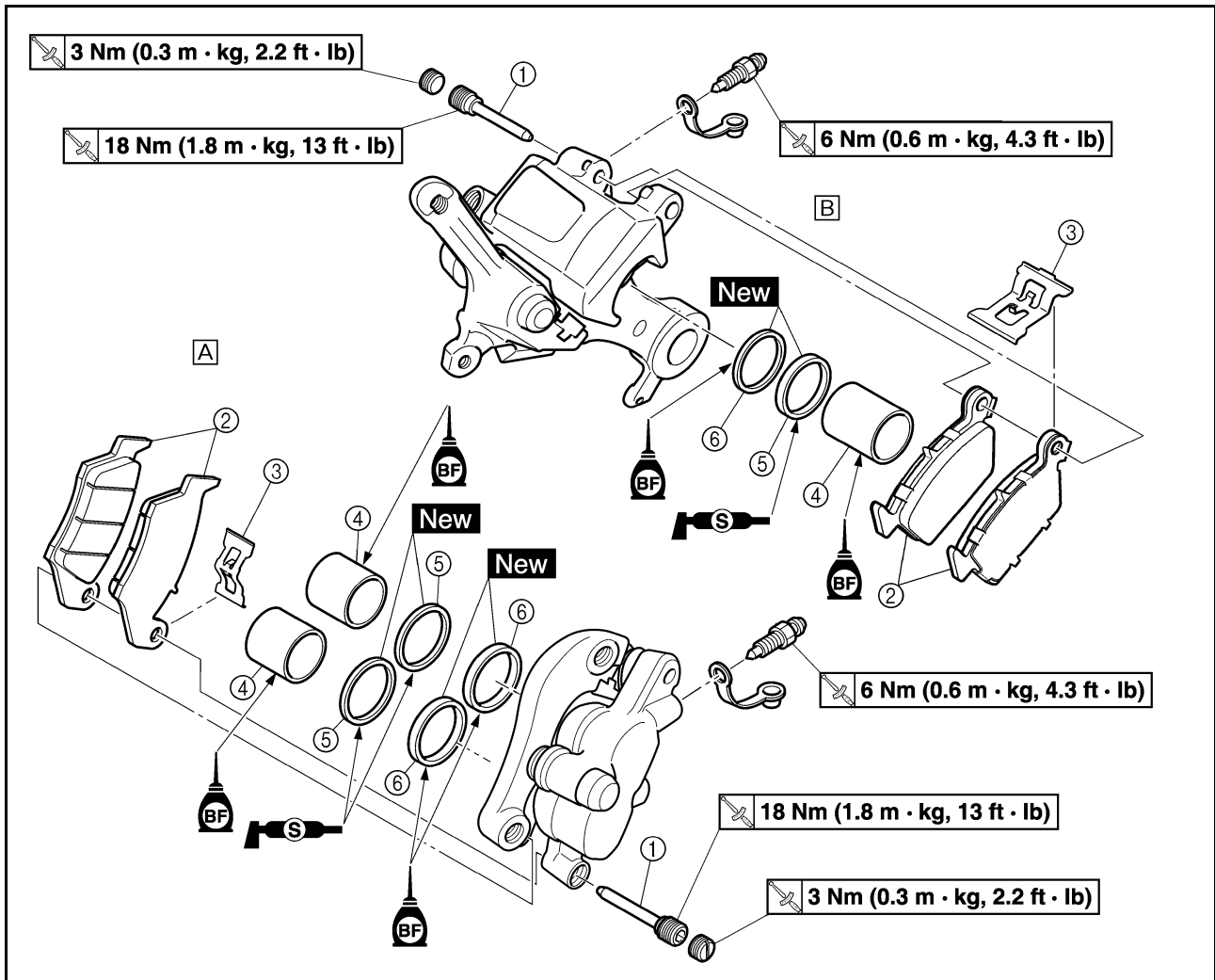

Order	Part name	Q'ty		Remarks
				A. Front B. Rear
		A	B	
1	Pad pin	1	1	
2	Brake pad	2	2	
3	Pad support	1	1	
4	Brake caliper piston	2	1	Refer to removal section.
5	Brake caliper piston dust seal	2	1	Refer to removal section.
6	Brake caliper piston seal	2	1	Refer to removal section.

FRONT BRAKE AND REAR BRAKE

DISASSEMBLING THE BRAKE MASTER CYLINDER

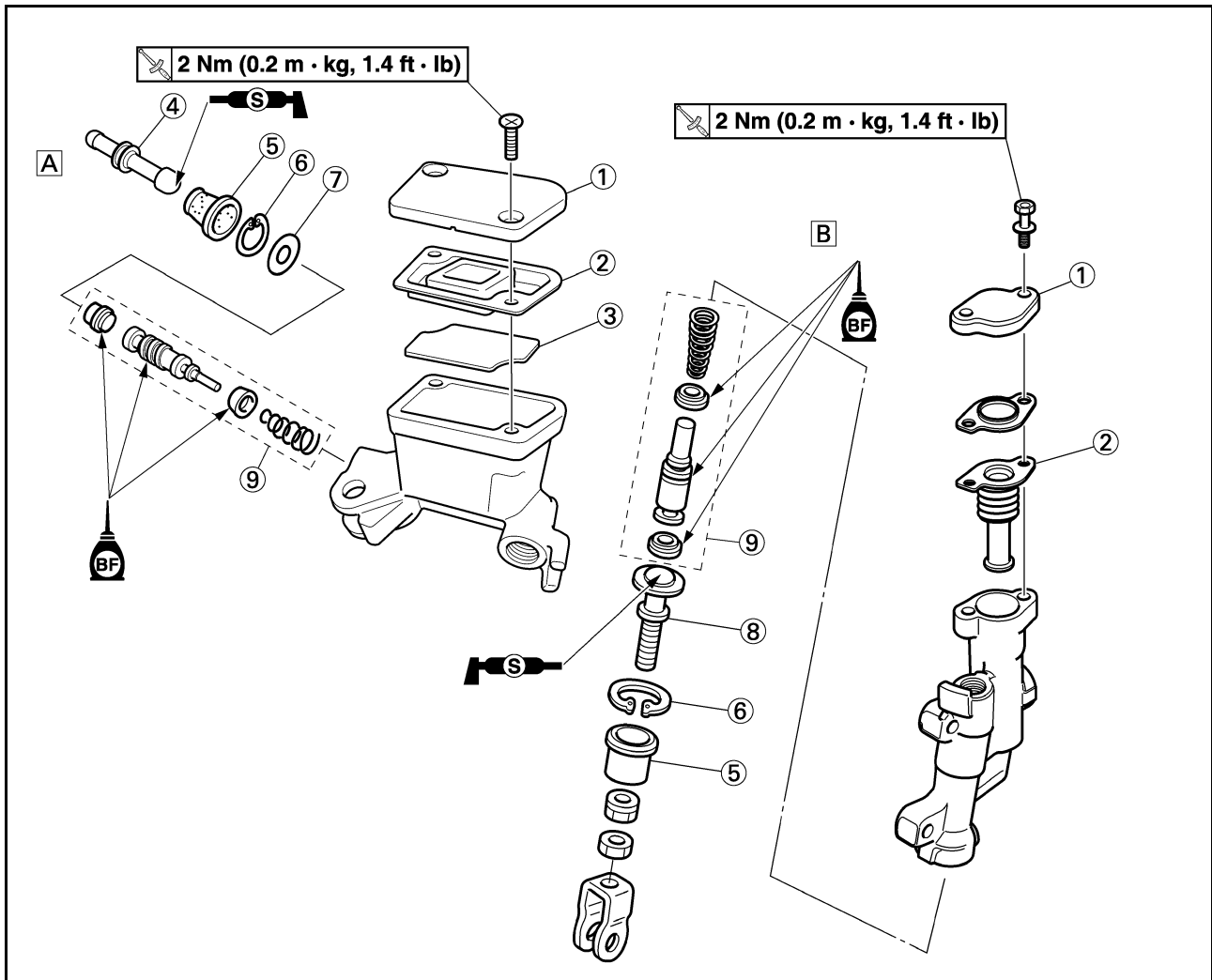

Order	Part name	Q'ty	Remarks
			A. Front B. Rear
1	Brake master cylinder cap	1	
2	Diaphragm	1	
3	Reservoir float	1	
4	Push rod (Front)	1	
5	Brake master cylinder boot	1	
6	Circlip	1	Use a long nose circlip pliers.
7	Washer	1	
8	Push rod (Rear)	1	
9	Brake master cylinder kit	1	

FRONT BRAKE AND REAR BRAKE

HANDLING NOTE

⚠ WARNING

Support the machine securely so there is no danger of it falling over.

DRAINING THE BRAKE FLUID

- Remove:
 - Brake master cylinder cap "1"
 - Protector (rear brake)

TIP

Do not remove the diaphragm.

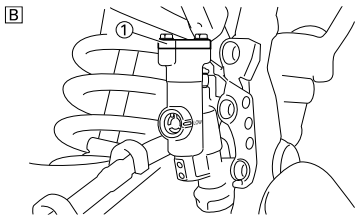
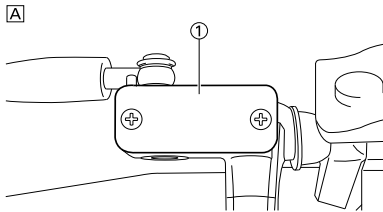

- A. Front
B. Rear

- Connect the transparent hose "2" to the bleed screw "1" and place a suitable container under its end.

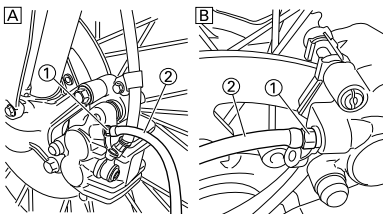

- A. Front
B. Rear

- Loosen the bleed screw and drain the brake fluid while pulling the lever in or pushing down on the pedal.

⚠ WARNING

- Do not reuse the drained brake fluid.
- Brake fluid may erode painted surfaces or plastic parts. Always clean up spilled fluid immediately.

REMOVING THE BRAKE CALIPER PISTON

- Remove:
 - Brake caliper piston
 Use compressed air and proceed carefully.

⚠ WARNING

- Cover piston with rag and use extreme caution when expelling piston from cylinder.
- Never attempt to pry out piston.



Caliper piston removal steps:

- Insert a piece of rag into the brake caliper to lock one brake caliper.
- Carefully force the piston out of the brake caliper cylinder with compressed air.

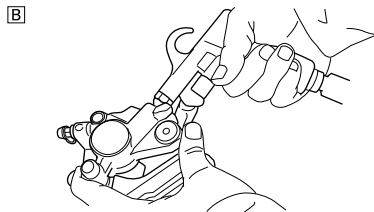
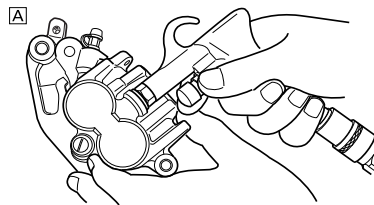

- A. Front
B. Rear



REMOVING THE BRAKE CALIPER PISTON SEAL KIT

- Remove:
 - Brake caliper piston dust seal "1"
 - Brake caliper piston seal "2"

TIP

Remove the brake caliper piston seals and brake caliper piston dust seals by pushing them with a finger.

NOTICE

Never attempt to pry out brake caliper piston seals and brake caliper piston dust seals.

⚠ WARNING

Replace the brake caliper piston seals and brake caliper piston dust seals whenever a caliper is disassembled.

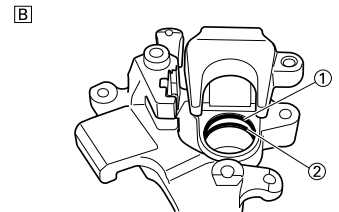
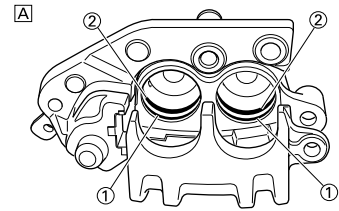

- A. Front
B. Rear

CHECKING THE BRAKE MASTER CYLINDER

- Inspect:
 - Brake master cylinder inner surface "a"
 Wear/scratches → Replace master cylinder assembly.
 Stains → Clean.

⚠ WARNING

Use only new brake fluid.

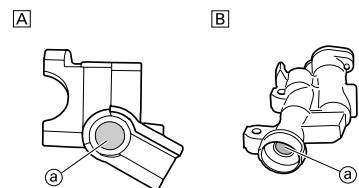

- A. Front
B. Rear

- Inspect:
 - Diaphragm "1"
 Crack/damage → Replace.

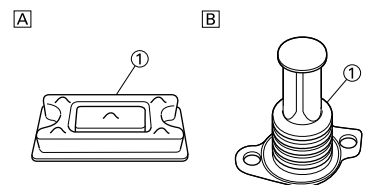

- A. Front
B. Rear

FRONT BRAKE AND REAR BRAKE

3. Inspect: (front brake only)

- Reservoir float "1"
Damage → Replace.

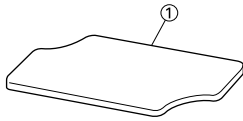

4. Inspect:

- Brake master cylinder piston "1"
- Brake master cylinder cup "2"
Wear/damage/score marks → Replace brake master cylinder kit.

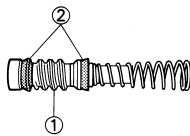

CHECKING THE BRAKE CALIPER

1. Inspect:

- Brake caliper cylinder inner surface "a"
Wear/score marks → Replace brake caliper assembly.

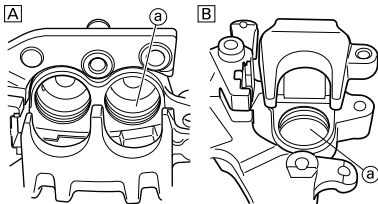

- A. Front
- B. Rear

2. Inspect:

- Brake caliper piston "1"
Wear/score marks → Replace brake caliper piston assembly.

⚠ WARNING

Replace the brake caliper piston seals and brake caliper piston dust seals "2" whenever a caliper is disassembled.

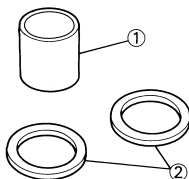

CHECKING THE BRAKE HOSE

1. Inspect:

- Brake hose "1"
Crack/damage → Replace.

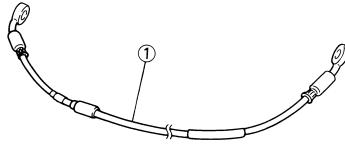

HANDLING NOTE

⚠ WARNING

- All internal parts should be cleaned in new brake fluid only.
- Internal parts should be lubricated with brake fluid when installed.
- Replace the brake caliper piston seals and brake caliper piston dust seals whenever a caliper is disassembled.

INSTALLING THE BRAKE CALIPER PISTON

1. Clean:

- Brake caliper
- Brake caliper piston seal
- Brake caliper piston dust seal
- Brake caliper piston
Clean them with brake fluid.

2. Install:

- Brake caliper piston seal "1"
New
- Brake caliper piston dust seal "2"
New

⚠ WARNING

Always use new brake caliper piston seals and brake caliper piston dust seals.

TIP

- Apply the brake fluid on the brake caliper piston seal.
- Apply the silicone grease on the brake caliper piston dust seal.
- Fit the brake caliper piston seals and brake caliper piston dust seals onto the slot on brake caliper correctly.

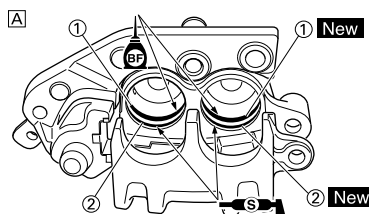

B

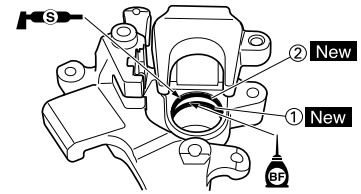

- A. Front
- B. Rear

3. Install:

- Brake caliper piston "1"

TIP

Apply the brake fluid on the piston wall.

NOTICE

- Install the piston with its shallow depressed side "a" facing the brake caliper.
- Never force to insert.

A

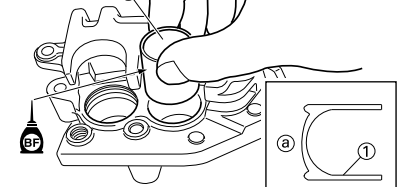

B

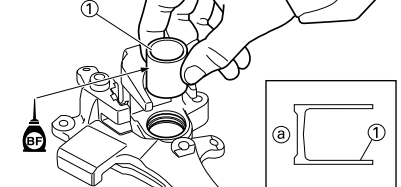

- A. Front
- B. Rear

INSTALLING THE FRONT BRAKE CALIPER

1. Install:

- Pad support "1"
- Brake pad "2"
- Pad pin "3"

TIP

- Install the brake pads with their projections "a" into the brake caliper recesses "b".
- Temporarily tighten the pad pin at this point.

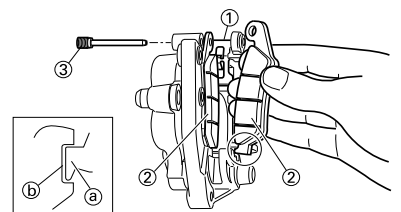

FRONT BRAKE AND REAR BRAKE

2. Install:

- Brake caliper "1"
- Bolt (brake caliper) "2"

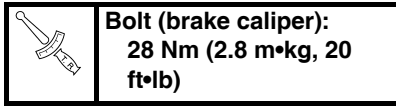

3. Tighten:

- Pad pin "3"

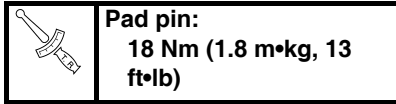

4. Install:

- Pad pin plug "4"

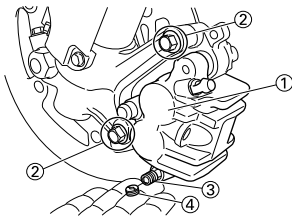
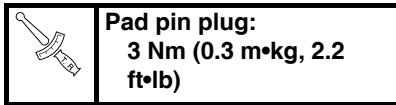

INSTALLING THE REAR BRAKE CALIPER

1. Install:

- Pad support "1"
- Brake pad "2"
- Pad pin "3"

TIP

- Install the brake pads with their projections "a" into the brake caliper recesses "b".
- Temporarily tighten the pad pin at this point.

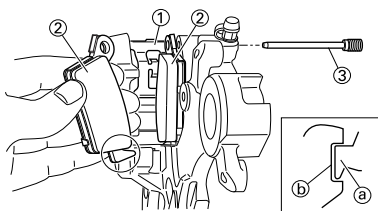

2. Install:

- Brake disc cover "1"
- Bolt (brake disc cover) "2"

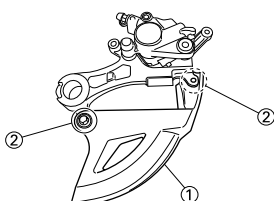
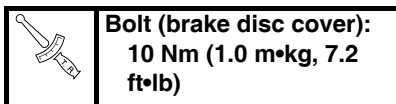

3. Install:

- Brake caliper "1"
 - Rear wheel "2"
- Refer to "FRONT WHEEL AND REAR WHEEL" section.

4. Tighten:

- Pad pin "3"

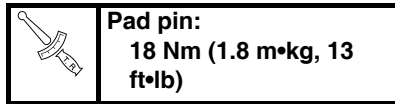

5. Install:

- Pad pin plug "4"

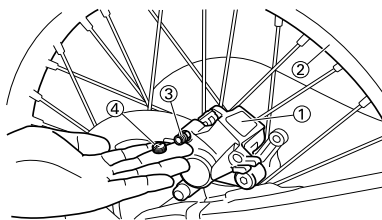
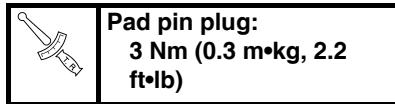

INSTALLING THE BRAKE MASTER CYLINDER KIT

1. Clean:

- Brake master cylinder
 - Brake master cylinder kit
- Clean them with brake fluid.

2. Install:

- Brake master cylinder cup (primary) "1"
 - Brake master cylinder cup (secondary) "2"
- To brake master cylinder piston "3".

TIP

Apply the brake fluid on the brake master cylinder cup.

WARNING

After installing, cylinder cup should be installed as shown direction. Wrong installation cause improper brake performance.

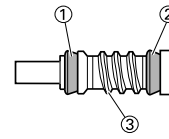
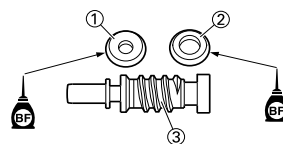

3. Install:

- Spring "1"
- To brake master cylinder piston "2".

TIP

Install the spring at the smaller diameter side.

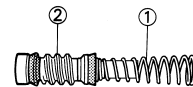

4. Install:

- Brake master cylinder kit "1"
 - Washer (front brake) "2"
 - Push rod (rear brake) "2"
 - Circlip "3"
 - Brake master cylinder boot "4"
 - Push rod (front brake) "5"
- To brake master cylinder.

TIP

- Apply the brake fluid on the brake master cylinder kit.
- Apply the silicone grease on the tip of the push rod.
- When installing the circlip, use a long nose circlip pliers.

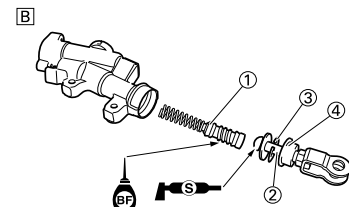
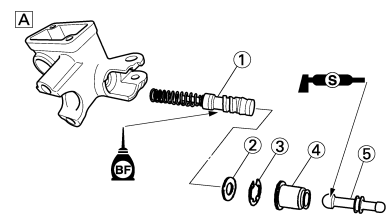

- A. Front
- B. Rear

FRONT BRAKE AND REAR BRAKE

INSTALLING THE FRONT BRAKE MASTER CYLINDER

- Install:
 - Brake master cylinder "1"
 - Brake master cylinder bracket "2"
 - Bolt (brake master cylinder bracket) "3"

	Bolt (brake master cylinder bracket): 9 Nm (0.9 m•kg, 6.5 ft•lb)
---	--

- TIP**
- Install the bracket so that the arrow mark "a" face upward.
 - First tighten the bolts on the upper side of the brake master cylinder bracket, and then tighten the bolts on the lower side.

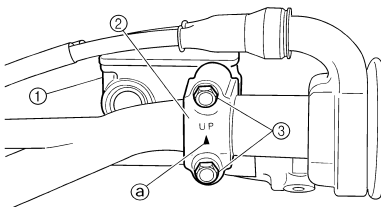

- Install:
 - Brake lever "1"
 - Bolt (brake lever) "2"

	Bolt (brake lever): 6 Nm (0.6 m•kg, 4.3 ft•lb)
---	--

- Nut (brake lever) "3"

	Nut (brake lever): 6 Nm (0.6 m•kg, 4.3 ft•lb)
---	---

- TIP**
- Apply the silicone grease on the brake lever sliding surface, bolt and tip of the push rod.

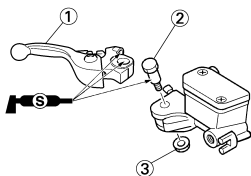

INSTALLING THE REAR BRAKE MASTER CYLINDER

- Install:
 - Copper washer "1" **New**
 - Brake hose "2"
 - Union bolt "3"

	Union bolt: 30 Nm (3.0 m•kg, 22 ft•lb)
---	--

- WARNING**
- Always use new copper washers.

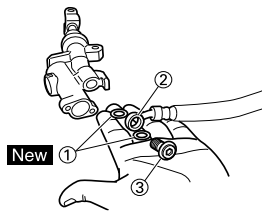

- NOTICE**
- Install the brake hose so that its pipe portion "a" directs as shown and lightly touches the projection "b" on the brake master cylinder.

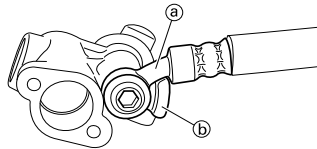

- Install:
 - Brake master cylinder "1"
 - Bolt (brake master cylinder) "2"

	Bolt (brake master cylinder): 10 Nm (1.0 m•kg, 7.2 ft•lb)
---	---

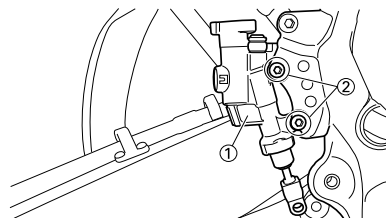

- Install:
 - Spring "1"
 - Brake pedal "2"
 - O-ring "3" **New**
 - Bolt (brake pedal) "4"

	Bolt (brake pedal): 26 Nm (2.6 m•kg, 19 ft•lb)
---	--

- Clip "5"

- TIP**
- Apply the lithium soap base grease on the bolt, O-ring and brake pedal bracket.

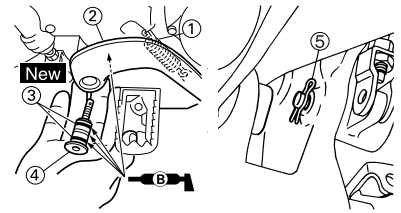

- Install:
 - Pin "1"
 - Washer "2"
 - Cotter pin "3" **New**

- TIP**
- After installing, check the brake pedal height. Refer to "ADJUSTING THE REAR BRAKE" section in the CHAPTER 3.

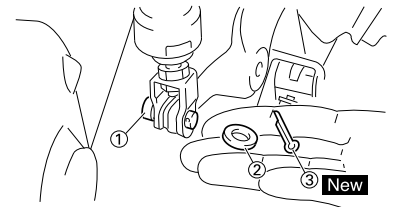

INSTALLING THE FRONT BRAKE HOSE

- Install:
 - Copper washer "1" **New**
 - Brake hose "2"
 - Union bolt "3"

	Union bolt: 30 Nm (3.0 m•kg, 22 ft•lb)
---	--

- WARNING**
- Always use new copper washers.

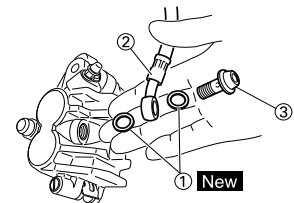

- NOTICE**
- Install the brake hose so that its pipe portion "a" directs as shown and lightly touches the projection "b" on the brake caliper.

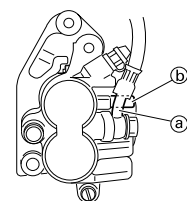

FRONT BRAKE AND REAR BRAKE

2. Install:

- Brake hose holder "1"
- Bolt (brake hose holder) "2"



Bolt (brake hose holder):
8 Nm (0.8 m•kg, 5.8 ft•lb)

TIP

Align the top "a" of the brake hose holder with the paint "b" of the brake hose.

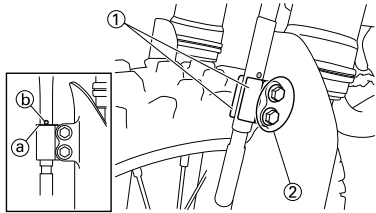

3. Pass the brake hose through the cable guide "1".

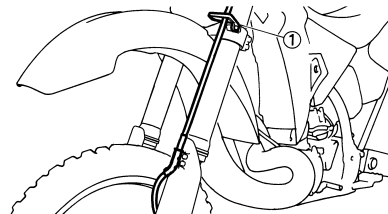

4. Install:

- Copper washer "1" **New**
- Brake hose "2"
- Union bolt "3"



Union bolt:
30 Nm (3.0 m•kg, 22 ft•lb)

WARNING

Always use new copper washers.

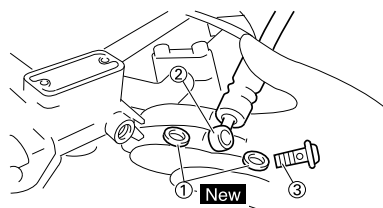

NOTICE

Install the brake hose so that its pipe portion "a" directs as shown and lightly touches the projection "b" on the brake master cylinder.

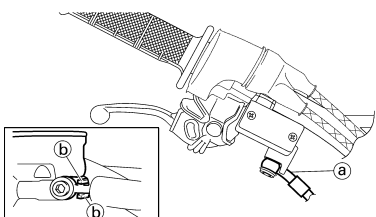

INSTALLING THE REAR BRAKE HOSE

1. Install:

- Copper washer "1" **New**
- Brake hose "2"
- Union bolt "3"



Union bolt:
30 Nm (3.0 m•kg, 22 ft•lb)

WARNING

Always use new copper washers.

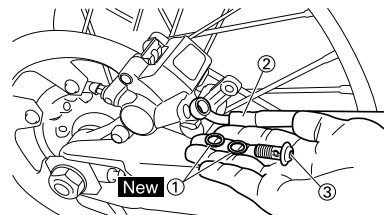

NOTICE

Install the brake hose so that its pipe portion "a" directs as shown and lightly touches the projection "b" on the brake caliper.

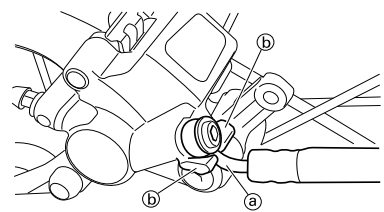

2. Install:

- Brake hose holder "1"
- Screw (brake hose holder) "2"



Screw (brake hose holder):
3 Nm (0.3 m•kg, 2.2 ft•lb)

NOTICE

After installing the brake hose holders, make sure the brake hose does not contact the spring (rear shock absorber). If it does, correct its twist.

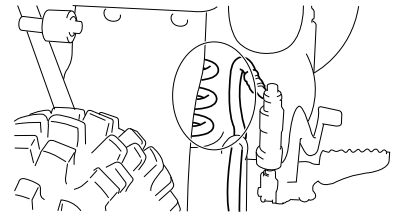
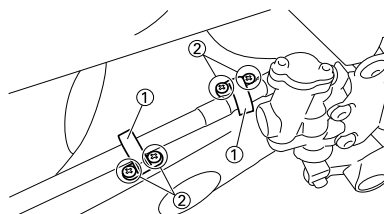

FILLING THE BRAKE FLUID

1. Fill:

- Brake fluid
Until the fluid level reaches "LOWER" level line "a".



Recommended brake fluid:
DOT #4

WARNING

- Use only the designated quality brake fluid; otherwise, the rubber seals may deteriorate, causing leakage and poor brake performance.
- Refill with the same type of brake fluid; mixing fluids may result in a harmful chemical reaction and lead to poor performance.
- Be careful that water does not enter the master cylinder when refilling. Water will significantly lower the boiling point of the fluid and may result in vapor lock.

NOTICE

Brake fluid may erode painted surfaces or plastic parts. Always clean up spilled fluid immediately.

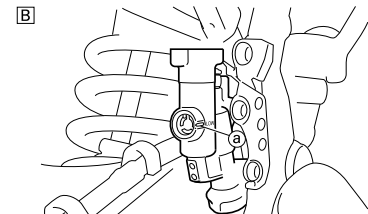
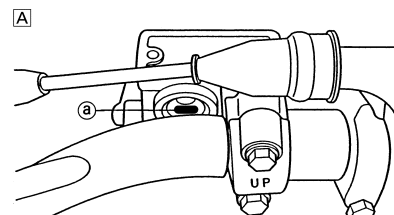

- A. Front
- B. Rear

FRONT BRAKE AND REAR BRAKE

2. Air bleed:
 - Brake system
Refer to "BLEEDING THE HYDRAULIC BRAKE SYSTEM" section in the CHAPTER 3.
3. Inspect:
 - Brake fluid level
Fluid at lower level → Fill up.
Refer to "CHECKING THE BRAKE FLUID LEVEL" section in the CHAPTER 3.
4. Install:
 - Reservoir float (front brake)
 - Diaphragm
 - Brake master cylinder cap "1"
 - Screw (brake master cylinder cap) "2"

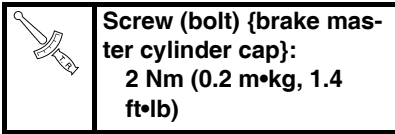

WARNING

After installation, while pulling the brake lever in or pushing down on the brake pedal, check whether there is any brake fluid leaking where the union bolts are installed respectively at the brake master cylinder and brake caliper.

5. Install: (rear brake only)
 - Protector "1"
 - Bolt (protector) "2"

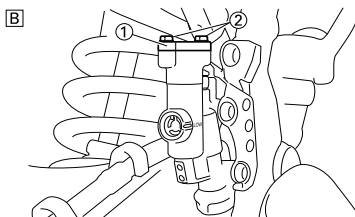
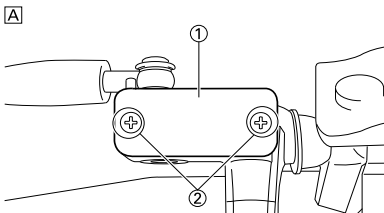
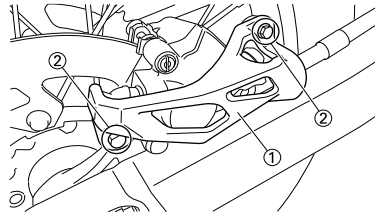
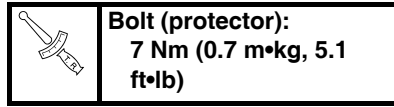

- A. Front
- B. Rear

FRONT FORK

FRONT FORK

REMOVING THE FRONT FORK

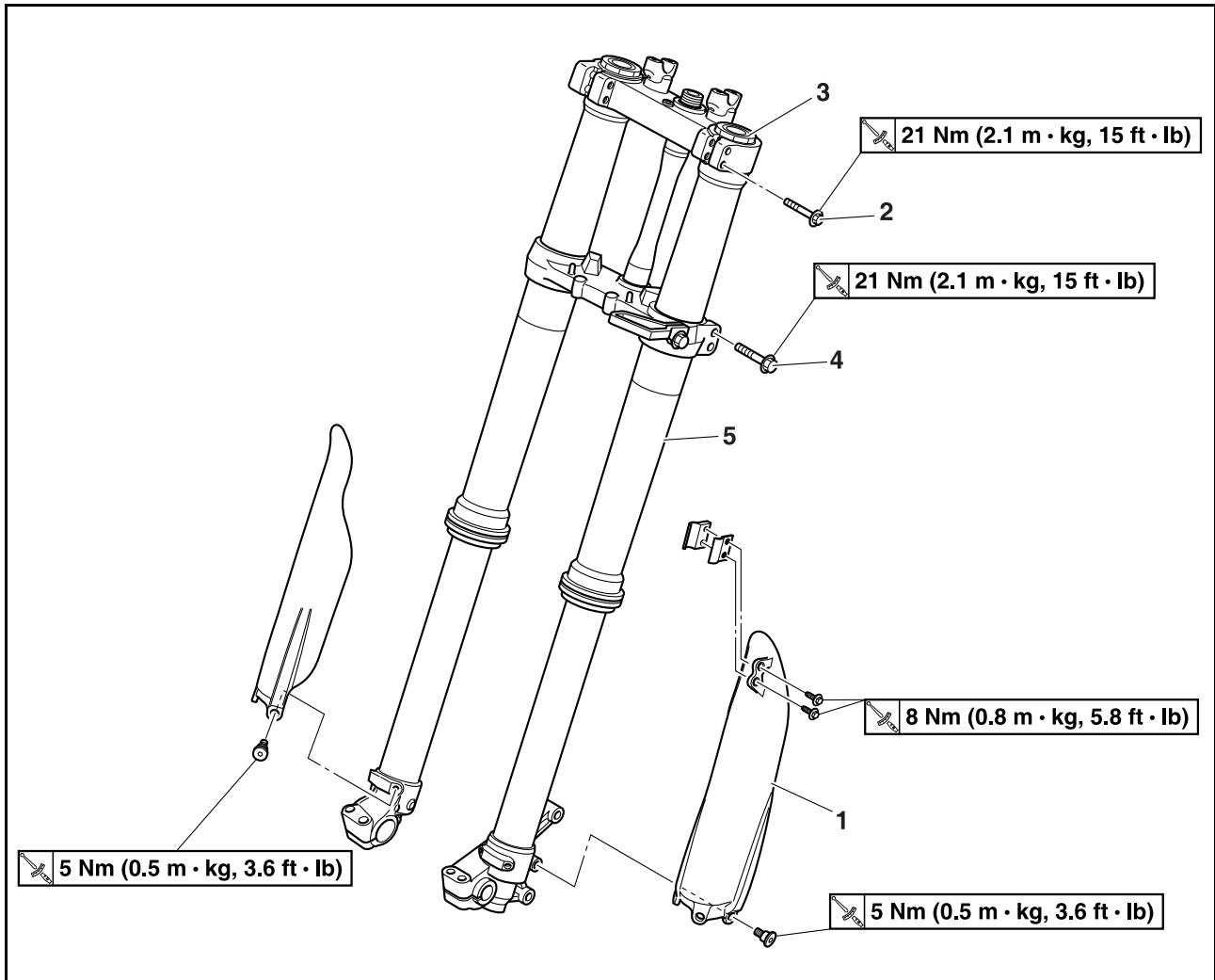

Order	Part name	Q'ty	Remarks
	Hold the machine by placing the suitable stand under the engine.		Refer to "HANDLING NOTE".
	Front wheel		Refer to "FRONT WHEEL AND REAR WHEEL" section.
	Front brake caliper		Refer to "FRONT BRAKE AND REAR BRAKE" section.
	Number plate		Refer to "SEAT, FUEL TANK AND SIDE COVERS" section in the CHAPTER 4.
1	Protector	1	
2	Pinch bolt (upper bracket)	2	Only loosening.
3	Damper assembly	1	Loosen when disassembling the front fork. Refer to removal section.
4	Pinch bolt (lower bracket)	2	Only loosening.
5	Front fork	1	

FRONT FORK

DISASSEMBLING THE FRONT FORK

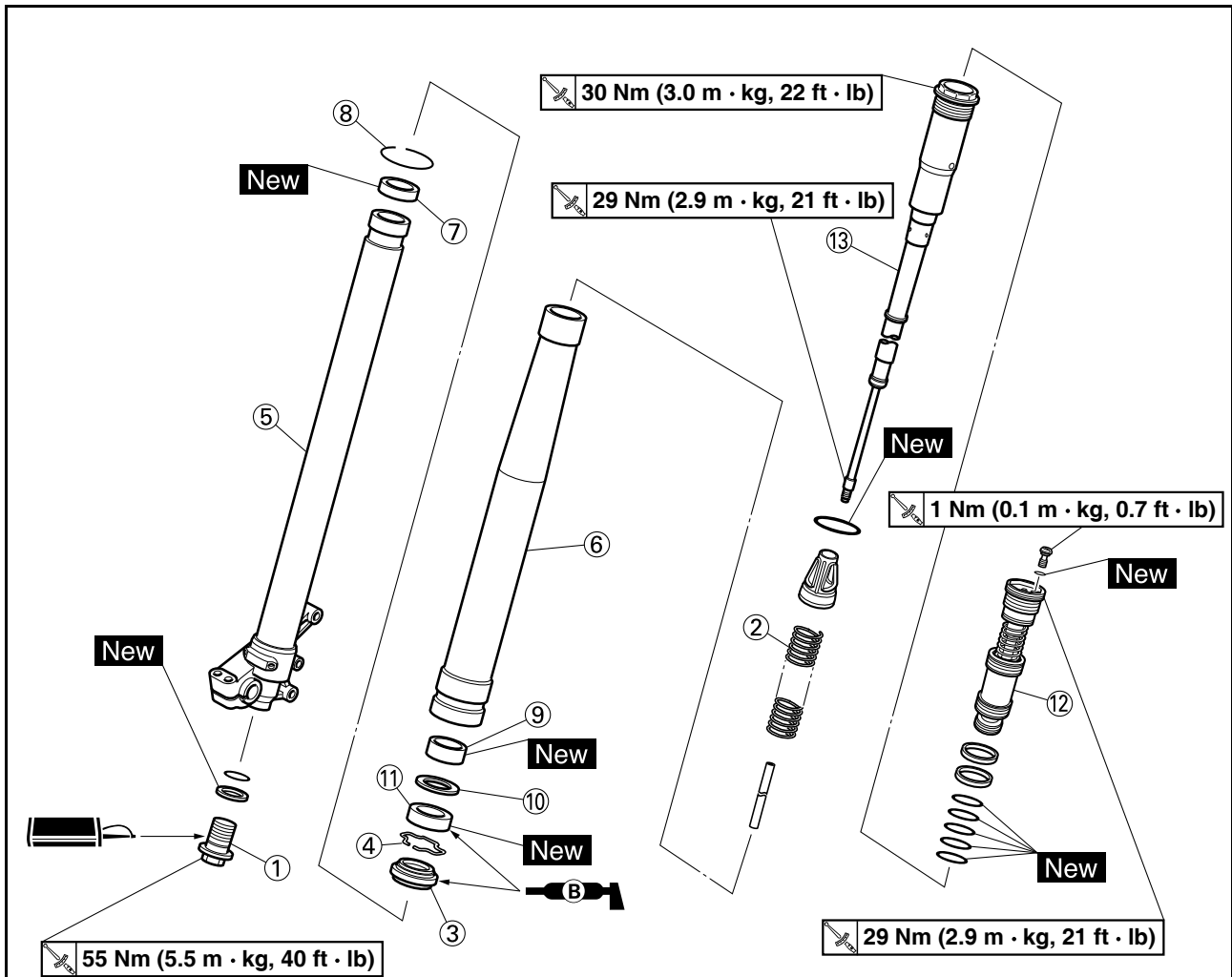

Order	Part name	Q'ty	Remarks
1	Adjuster	1	Drain the fork oil. Refer to removal section.
2	Fork spring	1	
3	Dust seal	1	Refer to removal section.
4	Stopper ring	1	Refer to removal section.
5	Inner tube	1	Refer to removal section.
6	Outer tube	1	
7	Piston metal	1	
8	Protector guide	1	
9	Slide metal	1	
10	Oil seal washer	1	
11	Oil seal	1	
12	Base valve	1	Drain the fork oil. Refer to removal section.
13	Damper assembly	1	Drain the fork oil. Refer to removal section.

HANDLING NOTE

⚠ WARNING

Support the machine securely so there is no danger of it falling over.

TIP

The front fork requires careful attention. So it is recommended that the front fork be maintained at the dealers.

NOTICE

To prevent an accidental explosion of air, the following instructions should be observed:

- The front fork with a built-in piston rod has a very sophisticated internal construction and is particularly sensitive to foreign material. Use enough care not to allow any foreign material to come in when the oil is replaced or when the front fork is disassembled and reassembled.
- Before removing the base valves or front forks, be sure to extract the air from the air chamber completely.

REMOVING THE DAMPER ASSEMBLY

- Loosen:
 - Damper assembly "1"

TIP

Before removing the front fork from the machine, loosen the damper assembly with the cap bolt ring wrench "2".



Cap bolt ring wrench:
YM-01501/90890-01501

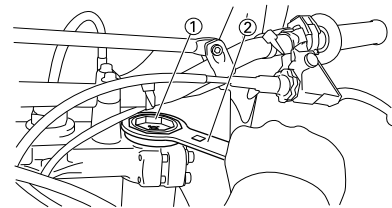

REMOVING THE ADJUSTER

- Drain the outer tube of its front fork oil at its top.
- Loosen:
 - Adjuster "1"

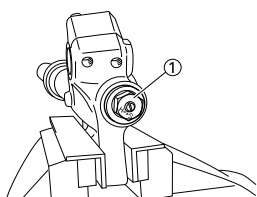

- Remove:
 - Adjuster "1"

TIP

- While compressing the inner tube "2", set the cap bolt ring wrench "4" between the inner tube and locknut "3".
- Hold the locknut and remove the adjuster.

NOTICE

Do not remove the locknut as the damper rod may go into the damper assembly and not be taken out.



Cap bolt ring wrench:
YM-01501/90890-01501

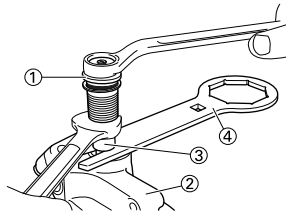

REMOVING THE INNER TUBE

- Remove:
 - Dust seal "1"
 - Stopper ring "2"
 Using slotted-head screwdriver.

NOTICE

Take care not to scratch the inner tube.

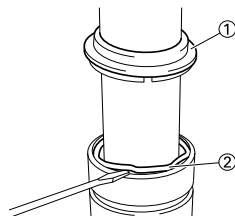

- Remove:
 - Inner tube "1"



Oil seal removal steps:

- Push in slowly "a" the inner tube just before it bottoms out and then pull it back quickly "b".
- Repeat this step until the inner tube can be pulled out from the outer tube.

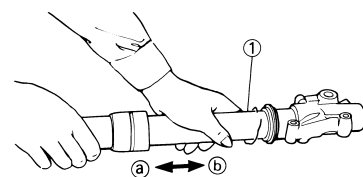

REMOVING THE BASE VALVE

- Remove:
 - Base valve "1"
 From damper assembly "2".

TIP

Hold the damper assembly with the cap bolt ring wrench "3" and use the cap bolt wrench "4" to remove the base valve.



Cap bolt wrench:
YM-01500/90890-01500
Cap bolt ring wrench:
YM-01501/90890-01501

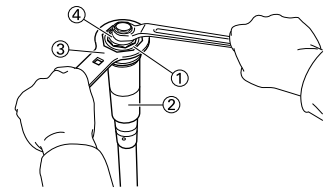

CHECKING THE DAMPER ASSEMBLY

- Inspect:
 - Damper assembly "1"
 - Bend/damage → Replace.
 - O-ring "2"
 - Wear/damage → Replace.

NOTICE

The front fork with a built-in piston rod has a very sophisticated internal construction and is particularly sensitive to foreign material. Use enough care not to allow any foreign material to come in when the oil is replaced or when the front fork is disassembled and reassembled.

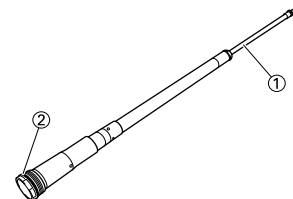

CHECKING THE BASE VALVE

- Inspect:
 - Base valve "1"
Wear/damage → Replace.
Contamination → Clean.
 - O-ring "2" **New**
Wear/damage → Replace.
 - Piston metal "3"
Wear/damage → Replace.
 - Spring "4"
Damage/fatigue → Replace base valve.
 - Air bleed screw "5"
Wear/damage → Replace.

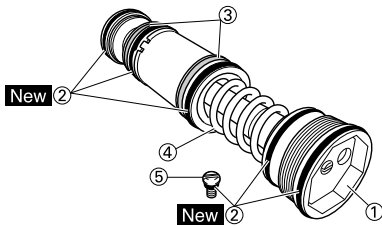

CHECKING THE COLLAR

- Inspect:
 - Contacting surface "a"
Wear/damage → Replace.

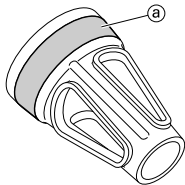

CHECKING THE FORK SPRING

- Measure:
 - Fork spring free length "a"
Out of specification → Replace.

	Fork spring free length "a":
	454.0 mm (17.87 in) <Limit>: 449.0 mm (17.68 in)

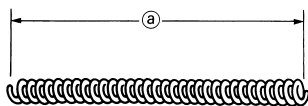

CHECKING THE INNER TUBE

- Inspect:
 - Inner tube surface "a"
Score marks → Repair or replace.
Use #1,000 grit wet sandpaper.
Damaged oil lock piece → Replace.
 - Inner tube bends
Out of specification → Replace.
Use the dial gauge "1".

	Inner tube bending limit:
	0.2 mm (0.01 in)

TIP
The bending value is shown by one half of the dial gauge reading.

! WARNING
Do not attempt to straighten a bent inner tube as this may dangerously weaken the tube.

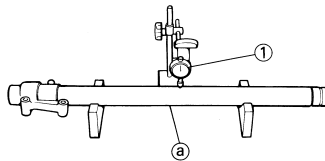

CHECKING THE OUTER TUBE

- Inspect:
 - Outer tube "1"
Score marks/wear/damage → Replace.

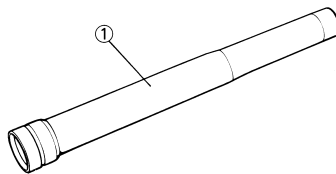

CHECKING THE ADJUSTER

- Inspect:
 - Adjuster "1"
 - O-ring "2" **New**
Wear/damage → Replace.

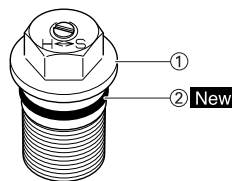

ASSEMBLING THE FRONT FORK

- Wash the all parts in a clean solvent.
- Stretch the damper assembly fully.
- Fill:
 - Front fork oil "1"
To damper assembly.

	Recommended oil:
	Suspension oil "S1"
	Oil capacity:
	203 cm³ (7.15 Imp oz, 6.86 US oz)

NOTICE

- Be sure to use recommended fork oil. If other oils are used, they may have an excessively adverse effect on the front fork performance.
- Never allow foreign materials to enter the front fork.

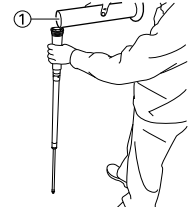

- After filling, pump the damper assembly "1" slowly up and down (about 200 mm (7.9 in) stroke) several times to bleed the damper assembly of air.

TIP
Be careful not to excessive full stroke. A stroke of 200 mm (7.9 in) or more will cause air to enter. In this case, repeat the steps 2 to 4.

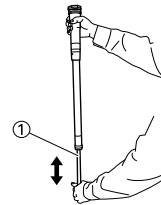

- Measure:
 - Oil level (left and right) "a"
Out of specification → Adjust.

	Standard oil level "a":
	145–148 mm (5.71–5.83 in)
	From top of fully stretched damper assembly.

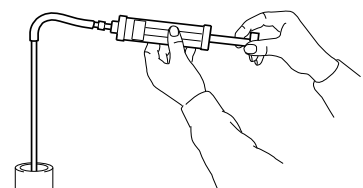
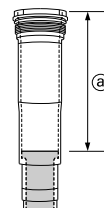

FRONT FORK

6. Tighten:

- Locknut "1"

TIP

Fully finger tighten the locknut onto the damper assembly.

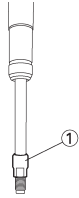

7. Loosen:

- Compression damping adjuster "1"

TIP

- Loosen the compression damping adjuster finger tight.
- Record the set position of the adjuster (the amount of turning out the fully turned in position).

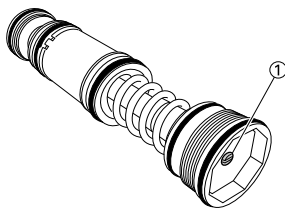

8. Install:

- Base valve "1"
To damper assembly "2".

TIP

First bring the damper rod pressure to a maximum. Then install the base valve while releasing the damper rod pressure.

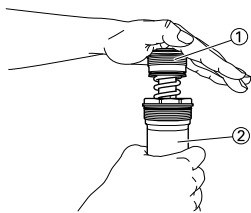

9. Check:

- Damper assembly
Not fully stretched → Repeat the steps 2 to 8.

10. Tighten:

- Base valve "1"



Base valve:
29 Nm (2.9 m•kg, 21 ft•lb)

TIP

Hold the damper assembly with the cap bolt ring wrench "2" and use the cap bolt wrench "3" to tighten the base valve with specified torque.



Cap bolt wrench:
YM-01500/90890-01500
Cap bolt ring wrench:
YM-01501/90890-01501

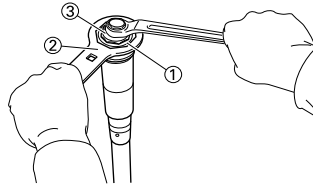

11. After filling, pump the damper assembly "1" slowly up and down more than 10 times to distribute the fork oil.

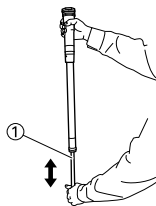

12. While protecting the damper assembly "1" with a rag and compressing fully, allow excessive oil to overflow on the base valve side.

NOTICE

Take care not to damage the damper assembly.



13. Allow the overflowing oil to escape at the hole "a" in the damper assembly.

TIP

The overflow measures about 8 cm³ (0.28 Imp oz, 0.27 US oz).

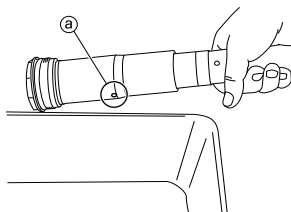

14. Check:

- Damper assembly smooth movement
Tightness/binding/rough spots → Repeat the steps 2 to 13.

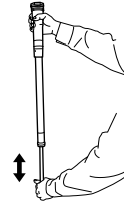

15. Install:

- Dust seal "1" **New**
- Stopper ring "2"
- Oil seal "3" **New**
- Oil seal washer "4"
- Slide metal "5" **New**
To inner tube "6".

NOTICE

Install the oil seal with its manufacturer's marks or number facing the axle holder side.

TIP

- Apply the lithium soap base grease on the dust seal lip and oil seal lip.
- Apply the fork oil on the inner tube.
- When installing the oil seal, use vinyl seat "a" with fork oil applied to protect the oil seal lip.

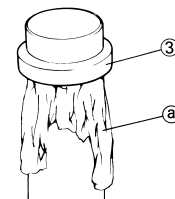
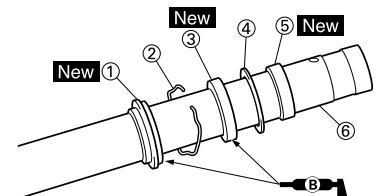

16. Install:

- Piston metal "1" **New**

TIP

Install the piston metal onto the slot on inner tube.

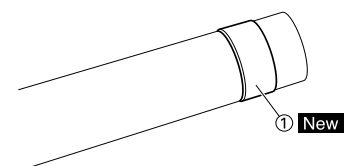

FRONT FORK

17. Install:

- Outer tube "1"
To inner tube "2".

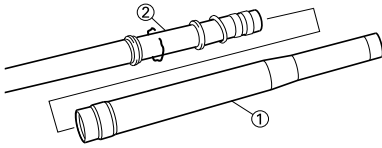

18. Install:

- Slide metal "1"
- Oil seal washer "2"
- To outer tube slot.

TIP

Press the slide metal into the outer tube with fork seal driver "3".



Fork seal driver:
YM-A0948/90890-01502

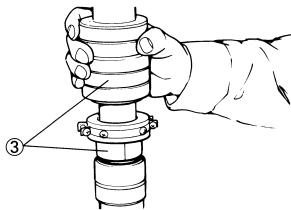
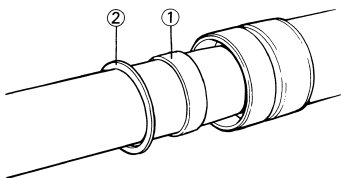

19. Install:

- Oil seal "1"

TIP

Press the oil seal into the outer tube with fork seal driver "2".



Fork seal driver:
YM-A0948/90890-01502

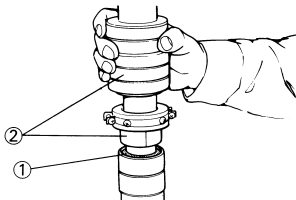

20. Install:

- Stopper ring "1"

TIP

Fit the stopper ring correctly in the groove in the outer tube.

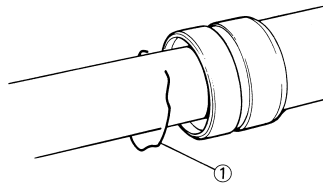

21. Install:

- Dust seal "1"

TIP

Apply the lithium soap base grease on the inner tube.

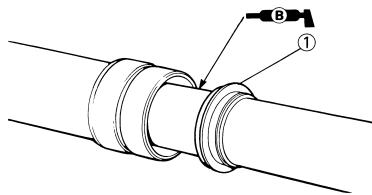

22. Check:

- Inner tube smooth movement
Tightness/binding/rough spots →
Repeat the steps 15 to 21.

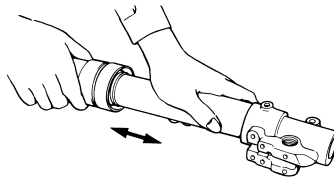

23. Measure:

- Distance "a"
Out of specification → Turn into the locknut.



Distance "a":
16 mm (0.63 in) or more
Between the damper
assembly "1" bottom
and locknut "2" bot-
tom.

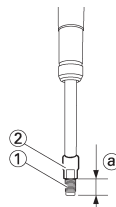

24. Install:

- Collar "1"
- Fork spring "2"
- To damper assembly "3".

TIP

Install the collar with its larger diameter end "a" facing the fork spring.

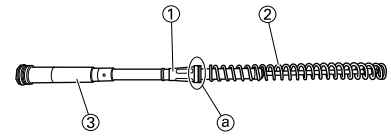

25. Install:

- Damper assembly "1"
- To inner tube "2".

NOTICE

To install the damper assembly into the inner tube, hold the inner tube aslant. If the inner tube is held vertically, the damper assembly may fall into it, damaging the valve inside.

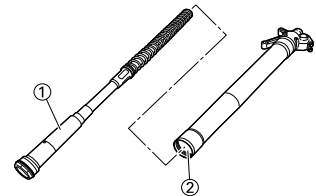

26. Loosen:

- Rebound damping adjuster "1"

TIP

- Loosen the rebound damping adjuster finger tight.
- Record the set position of the adjuster (the amount of turning out the fully turned in position).

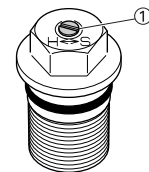

27. Install:

- Push rod "1"
- Copper washer "2" **New**
- Adjuster "3"
- To damper assembly "4".

TIP

- While compressing the inner tube "5", set the cap bolt ring wrench "7" between the inner tube and locknut "6".
- Fully finger tighten the adjuster onto the damper assembly.



Cap bolt ring wrench:
YM-01501/90890-01501

FRONT FORK

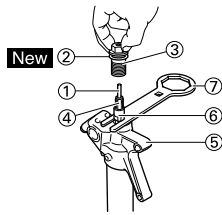

28. Inspect:

- Gap "a" between the adjuster "1" and locknut "2".
Out of specification → Retighten and readjust the locknut.

	Gap "a" between the adjuster and locknut: 0.5–1.0 mm (0.02–0.04 in)
--	---

TIP

If the adjuster is installed out of specification, proper damping force cannot be obtained.

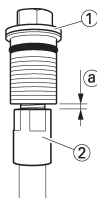

29. Tighten:

- Adjuster (locknut) "1"

	Adjuster (locknut): 29 Nm (2.9 m•kg, 21 ft•lb)
--	--

TIP

Hold the locknut "2" and tighten the adjuster with specified torque.

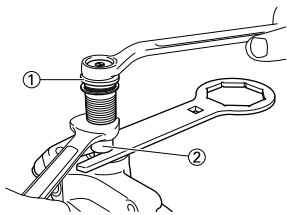

30. Install:

- Adjuster "1"

	Adjuster: 55 Nm (5.5 m•kg, 40 ft•lb)
--	--

To inner tube.

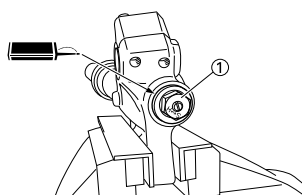

31. Fill:

- Front fork oil "1"
From outer tube top.

	Recommended oil: Suspension oil "S1" Standard oil amount: 320 cm ³ (11.3 Imp oz, 10.8 US oz) Extent of adjustment: 300–365 cm ³ (10.6–12.9 Imp oz, 10.1– 12.3 US oz)
--	---

WARNING

Never fail to make the oil amount adjustment between the maximum and minimum amount and always adjust each front fork to the same setting. Uneven adjustment can cause poor handling and loss of stability.

NOTICE

- Be sure to use recommended fork oil. If other oils are used, they may have an excessively adverse effect on the front fork performance.
- Never allow foreign materials to enter the front fork.

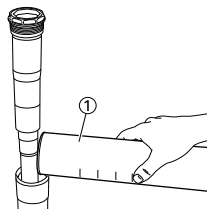

32. Install:

- Damper assembly "1"
To outer tube.

TIP

Temporarily tighten the damper assembly.

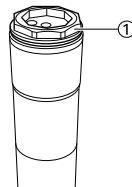

33. Install:

- Protector guide "1"

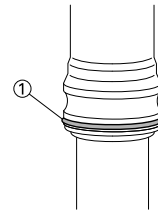

INSTALLING THE FRONT FORK

1. Install:

- Front fork "1"

TIP

- Temporarily tighten the pinch bolts (lower bracket).
- Do not tighten the pinch bolts (upper bracket) yet.

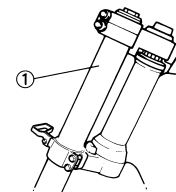

2. Tighten:

- Damper assembly "1"

	Damper assembly: 30 Nm (3.0 m•kg, 22 ft•lb)
--	---

TIP

Use the cap bolt ring wrench "2" to tighten the damper assembly with specified torque.

	Cap bolt ring wrench: YM-01501/90890-01501
--	--

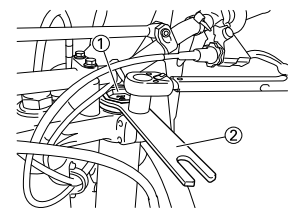

3. Adjust:

- Front fork top end "a"

	Front fork top end (standard) "a": 0 mm (0 in)
--	--

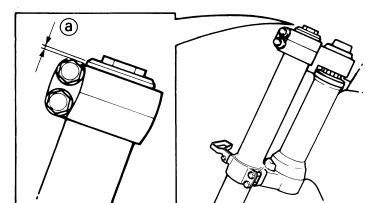

FRONT FORK

4. Tighten:

- Pinch bolt (upper bracket) "1"

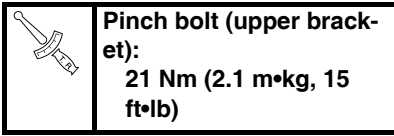

- Pinch bolt (lower bracket) "2"

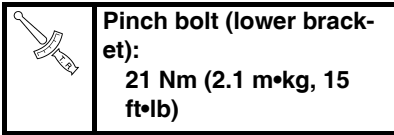

⚠ WARNING

Tighten the lower bracket to specified torque. If torqued too much, it may cause the front fork to malfunction.

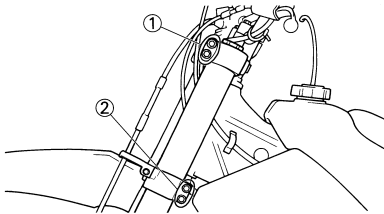

5. Install:

- Protector "1"
- Bolt (protector) "2"

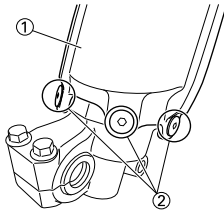
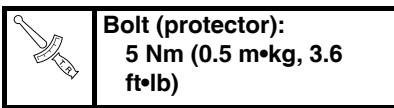

6. Adjust:

- Rebound damping force

TIP

Turn in the damping adjuster "1" finger-tight and then turn out to the originally set position.

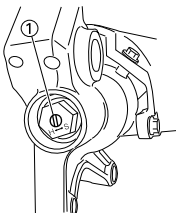

7. Adjust:

- Compression damping force

TIP

Turn in the damping adjuster "1" finger-tight and then turn out to the originally set position.

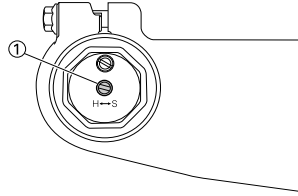

HANDLEBAR

REMOVING THE HANDLEBAR

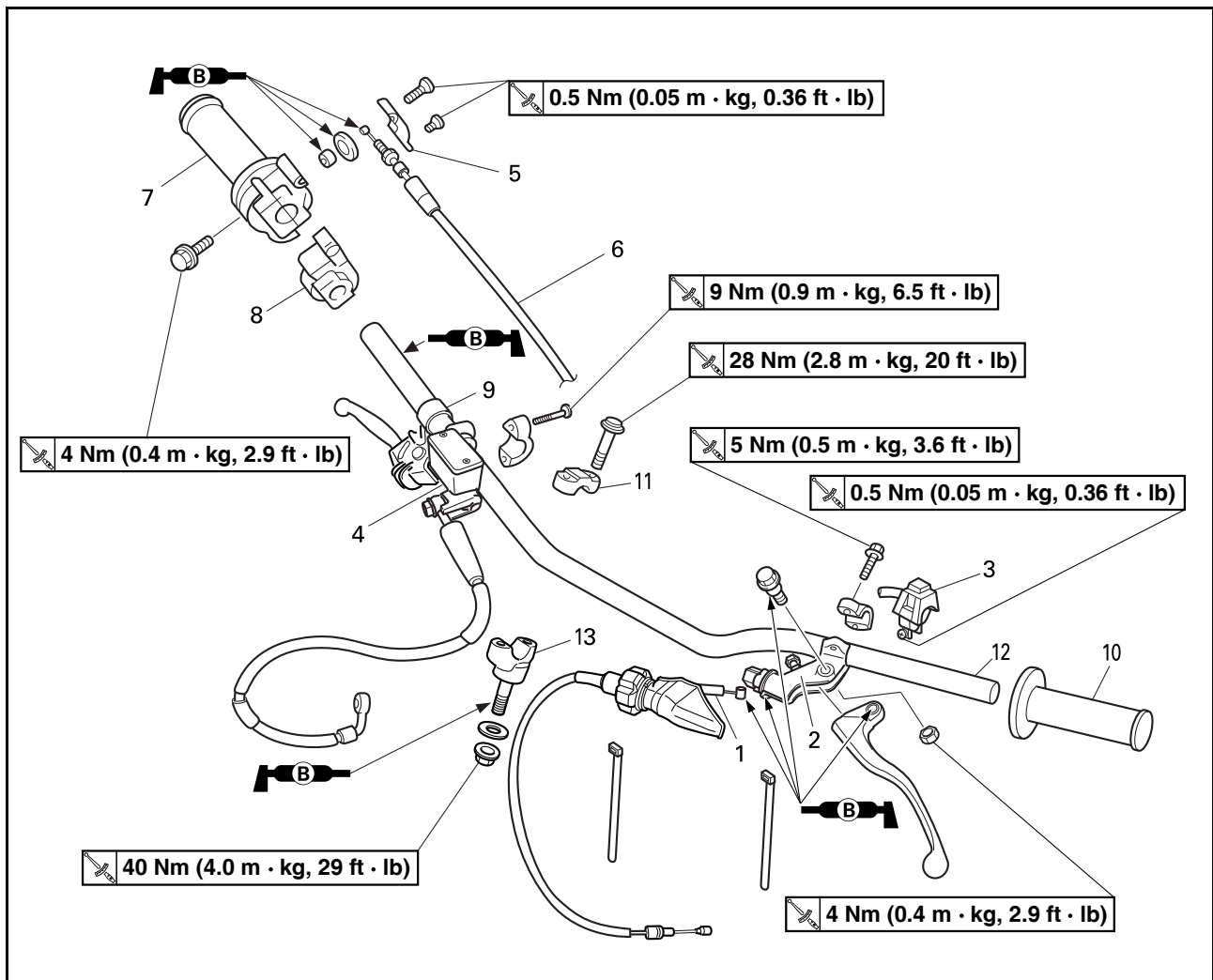

Order	Part name	Q'ty	Remarks
	Number plate		Remove the band only.
1	Clutch cable	1	Disconnect at the lever side.
2	Clutch lever holder	1	
3	Engine stop switch	1	
4	Brake master cylinder	1	Refer to removal section.
5	Throttle cable cap	1	Turn over the cap cover.
6	Throttle cable	1	Disconnect at the throttle side.
7	Throttle	1	Loosen the bolts.
8	Cap cover	1	
9	Collar	1	
10	Left grip	1	Refer to removal section.
11	Handlebar upper holder	2	
12	Handlebar	1	
13	Handlebar lower holder	2	

HANDLEBAR

DISASSEMBLING THE THROTTLE

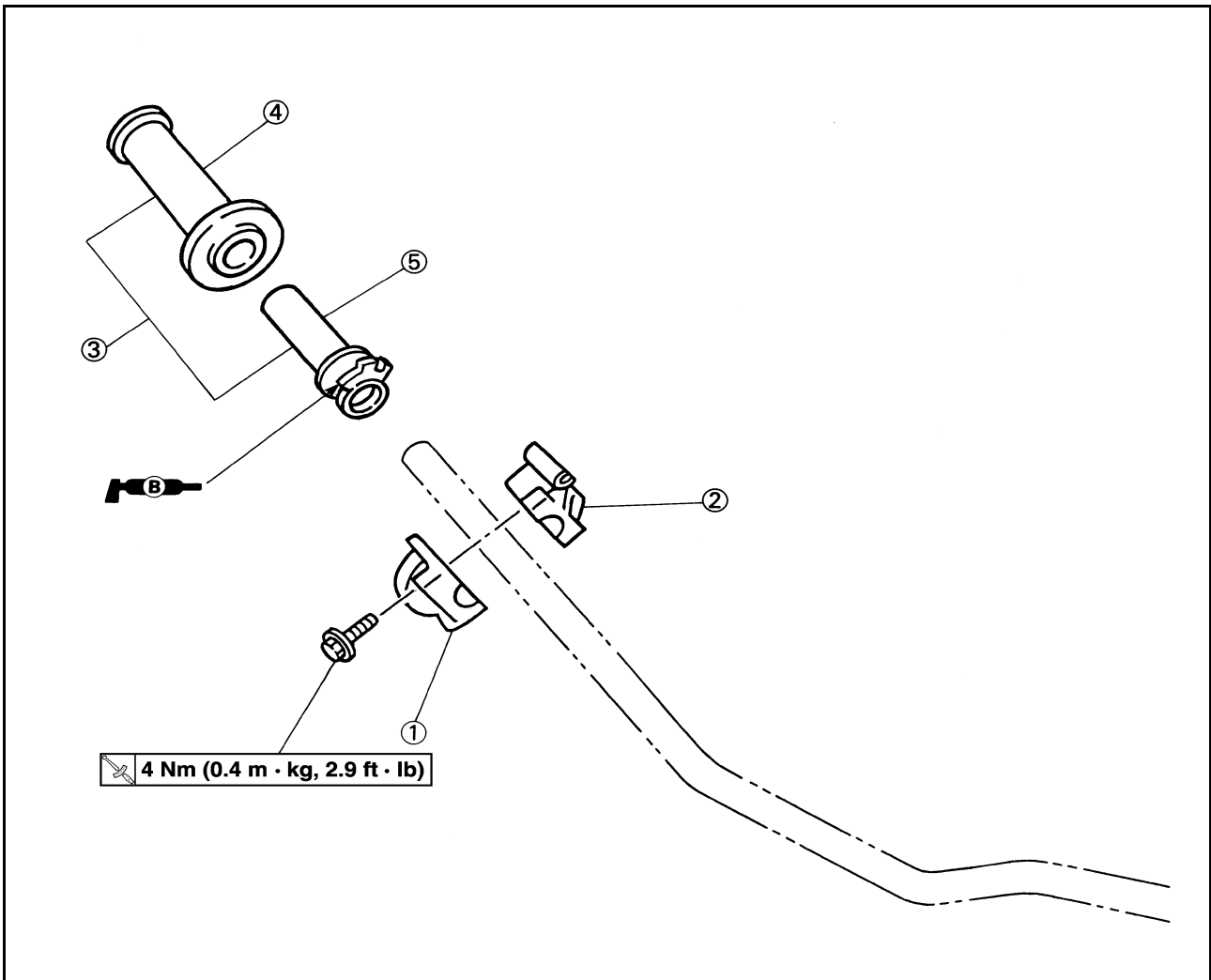

 4 Nm (0.4 m · kg, 2.9 ft · lb)

Order	Part name	Q'ty	Remarks
1	Grip cap (lower)	1	
2	Grip cap (upper)	1	
3	Grip assembly	1	
4	Grip (right)	1	Refer to removal section.
5	Tube guide	1	

REMOVING THE BRAKE MASTER CYLINDER

- Remove:
 - Brake master cylinder bracket "1"
 - Brake master cylinder "2"

NOTICE

- Do not let the brake master cylinder hang on the brake hose.
- Keep the brake master cylinder cap side horizontal to prevent air from coming in.

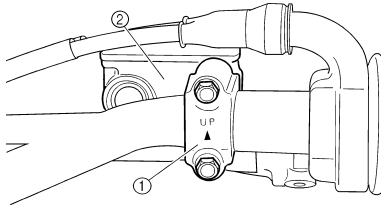

REMOVING THE GRIP

- Remove:
 - Grip "1"

TIP

Blow in air between the handlebar or tube guide and the grip. Then remove the grip which has become loose.

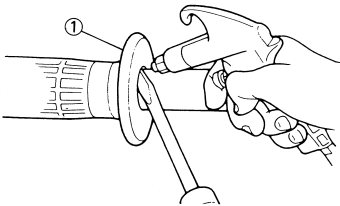

CHECKING THE HANDLEBAR

- Inspect:
 - Handlebar "1"
 - Bends/cracks/damage → Replace.

WARNING

Do not attempt to straighten a bent handlebar as this may dangerously weaken the handlebar.

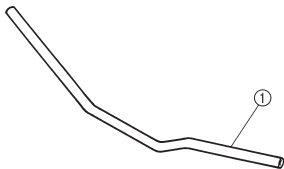

ASSEMBLING THE THROTTLE

- Remove:
 - Grip (right) "1"

Apply the adhesive on the tube guide "2".

TIP

- Before applying the adhesive, wipe off grease or oil on the tube guide surface "a" with a lacquer thinner.
- Align the mating mark "b" on the grip (right) with the slot "c" in the tube guide.

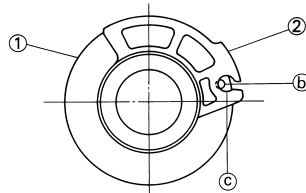
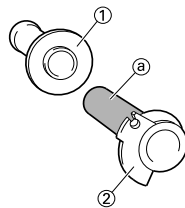

- Install:
 - Grip cap (upper) "1"
 - Grip cap (lower) "2"
 - Bolt (grip cap) "3"

TIP

Temporarily tighten the bolts (grip cap).

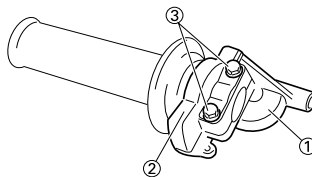

INSTALLING THE HANDLEBAR

- Install:
 - Handlebar lower holder "1"
 - Washer "2"
 - Nut (handlebar lower holder) "3"

TIP

- Install the handlebar lower holder with its side having the greater distance "a" from the mounting bolt center facing forward.
- Apply the lithium soap base grease on the thread of the handlebar lower holders.
- Installing the handlebar lower holder in the reverse direction allows the front-to-rear offset amount of the handlebar position to be changed.
- Do not tighten the nuts yet.

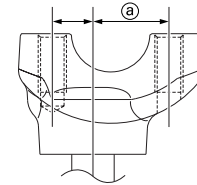
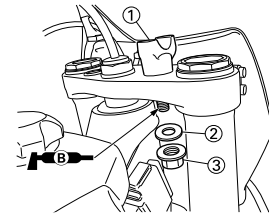

- Install:
 - Handlebar "1"
 - Handlebar upper holder "2"
 - Bolt (handlebar upper holder) "3"



Bolt (handlebar upper holder):
28 Nm (2.8 m•kg, 20 ft•lb)

TIP

- The handlebar upper holder should be installed with the punched mark "a" forward.
- Install the handlebar so that the marks "b" are in place on both sides.
- Install the handlebar so that the projection "c" of the handlebar upper holder is positioned at the mark on the handlebar as shown.
- First tighten the bolts on the front side of the handlebar upper holder, and then tighten the bolts on the rear side.

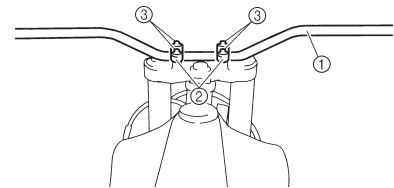

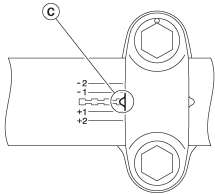
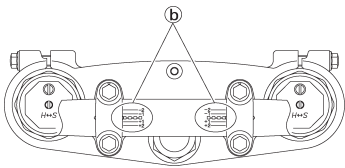

3. Tighten:
- Nut (handlebar lower holder) "1"

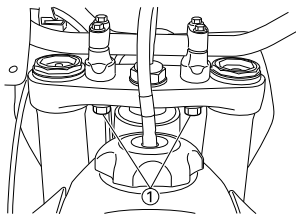
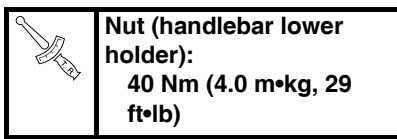

4. Install:
- Left grip "1"
 Apply the adhesive to the handlebar "2".

TIP

- Before applying the adhesive, wipe off grease or oil on the handlebar surface "a" with a lacquer thinner.
- Install the left grip to the handlebar so that the line "b" between the two arrow marks faces straight upward.

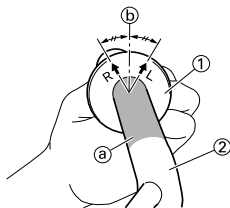

5. Install:
- Collar "1"
 - Grip cap cover "2"
 - Throttle grip "3"

TIP

- Apply the lithium soap base grease on the throttle grip sliding surface.
- Tighten the grip cap bolts temporarily without the throttle being fixed to the handlebar.

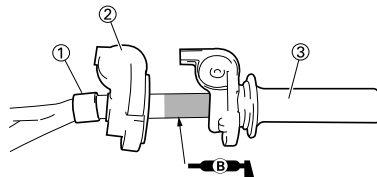

6. Install:
- Throttle cables "1"
 To tube guide "2".

TIP

Apply the lithium soap base grease on the throttle cable end and tube guide cable winding portion.

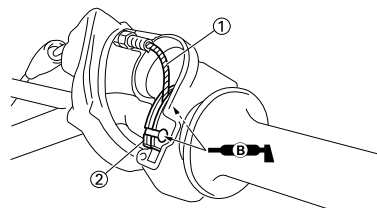

7. Install:
- Roller "1"
 - Collar "2"

TIP

- Apply the lithium soap base grease on the roller sliding surface and cable guide.
- Install the roller so that the "UPPER" mark "a" faces upward.
- Pass the throttle cable in the groove "b" in the roller.

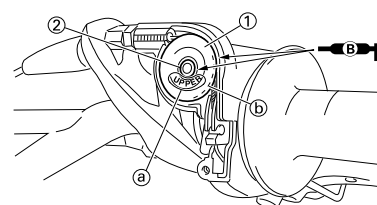

8. Install:
- Throttle cable cap "1"
 - Screw (throttle cable cap) "2"

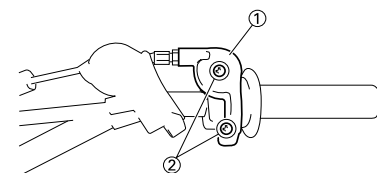
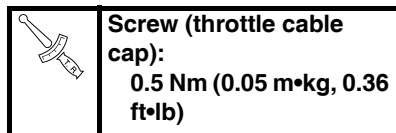

9. Adjust:
- Throttle grip free play
 Refer to "ADJUSTING THE THROTTLE GRIP FREE PLAY" section in the CHAPTER 3.
10. Install:
- Cap cover "1"

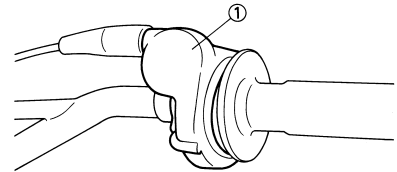

11. Install:
- Brake master cylinder "1"
 - Brake master cylinder bracket "2"
 - Bolt (brake master cylinder bracket) "3"

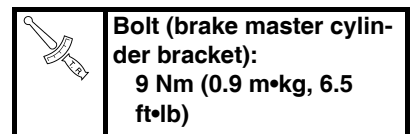

TIP

- Install the bracket so that the arrow mark "a" faces upward.
- First tighten the bolt on the upper side of the brake master cylinder bracket, and then tighten the bolt on the lower side.

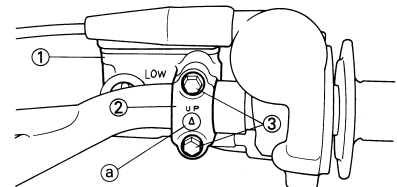

12. Install:
- Bolt (grip cap) "1"

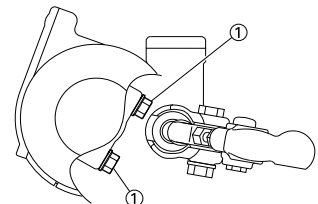
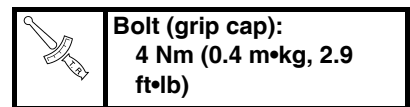

⚠ WARNING

After tightening the bolts, check that the throttle grip "2" moves smoothly. If it does not, retighten the bolts for adjustment.

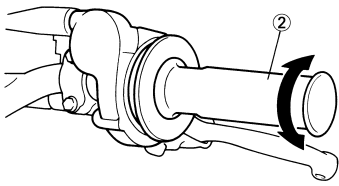

15. Adjust:

- Clutch lever free play
Refer to "ADJUSTING THE CLUTCH LEVER FREE PLAY" section in the CHAPTER 3.

13. Install:

- Engine stop switch "1"

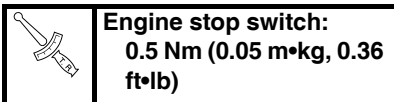

- Clutch lever holder "2"
- Bolt (clutch lever holder) "3"

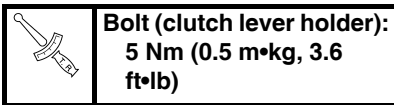

- Clamp "4"

TIP

- The engine stop switch, clutch lever holder and clamp should be installed according to the dimensions shown.
- Pass the engine stop switch lead in the middle of the clutch lever holder.

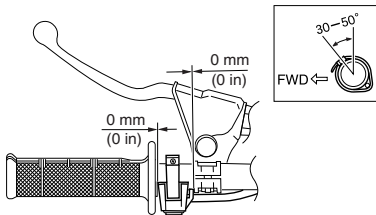
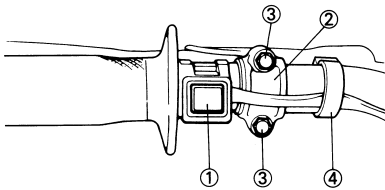

14. Install:

- Clutch cable "1"

TIP

Apply the lithium soap base grease on the clutch cable end.

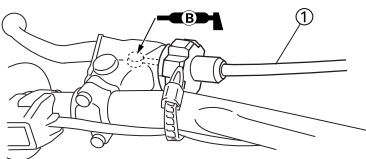

STEERING

REMOVING THE STEERING

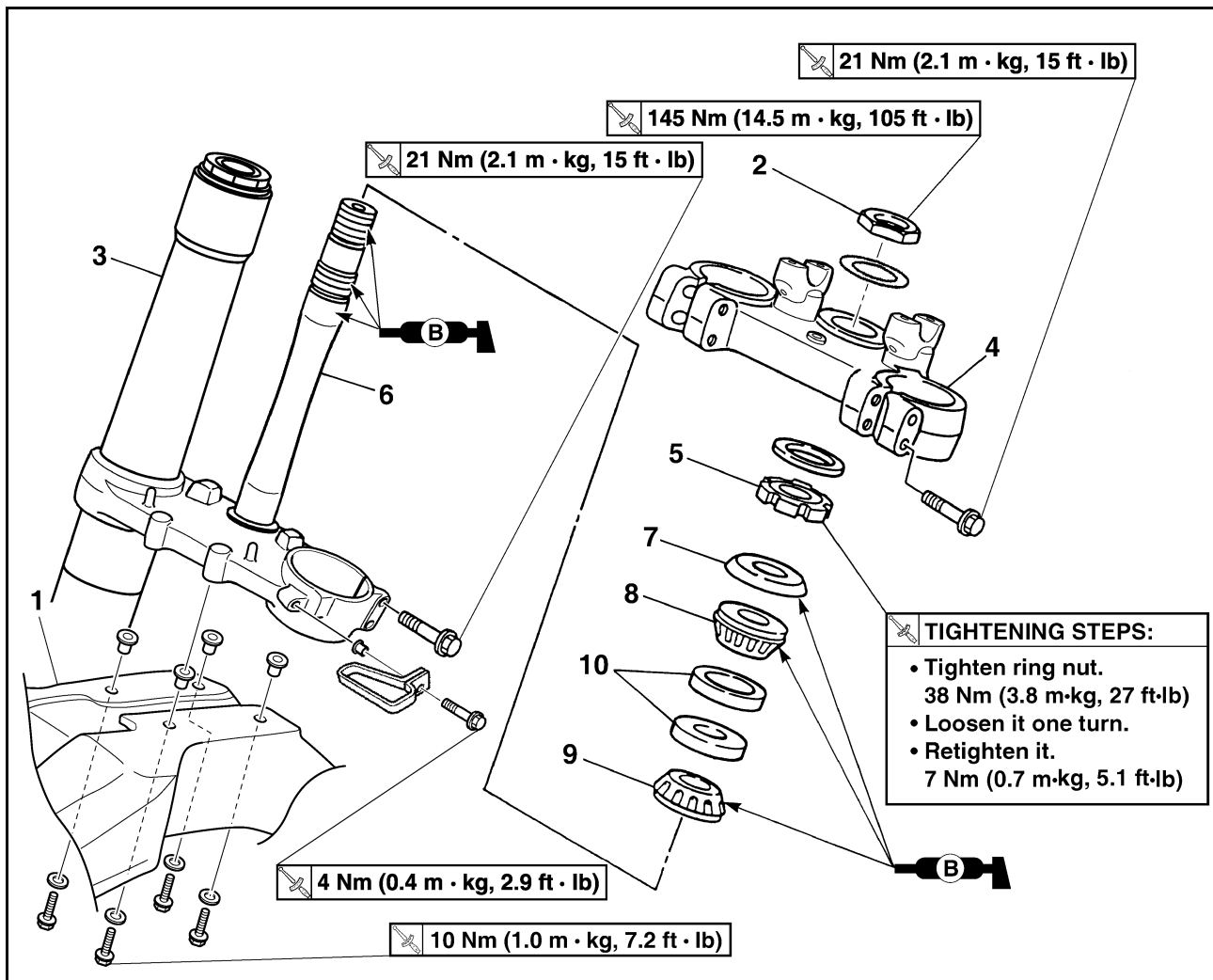

Order	Part name	Q'ty	Remarks
			TIGHTENING STEPS: <ul style="list-style-type: none"> • Tighten ring nut. 38 Nm (3.8 m·kg, 27 ft·lb) • Loosen it one turn. • Retighten it. 7 Nm (0.7 m·kg, 5.1 ft·lb)
	Hold the machine by placing the suitable stand under the engine.		Refer to "HANDLING NOTE".
	Number plate		Refer to "SEAT, FUEL TANK AND SIDE COVERS" section in the CHAPTER 4.
	Handlebar		Refer to "HANDLEBAR" section.
1	Front fender	1	
2	Steering stem nut	1	
3	Front fork	2	Refer to "FRONT FORK" section.
4	Upper bracket	1	
5	Steering ring nut	1	Refer to removal section.
6	Lower bracket	1	
7	Bearing race cover	1	
8	Upper bearing	1	
9	Lower bearing	1	Refer to removal section.
10	Bearing race	2	Refer to removal section.

HANDLING NOTE

⚠ WARNING

Support the machine securely so there is no danger of it falling over.

REMOVING THE STEERING RING NUT

- Remove:
 - Steering ring nut "1"
 - Use the steering nut wrench "2".



Steering nut wrench:
YU-A9472/90890-01403

⚠ WARNING

Support the steering stem so that it may not fall down.

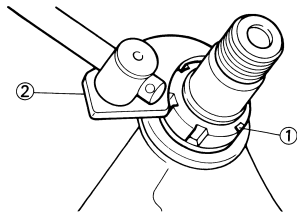

REMOVING THE LOWER BEARING

- Remove:
 - Lower bearing "1"
 - Use the floor chisel "2".

NOTICE

Take care not to damage the steering shaft thread.

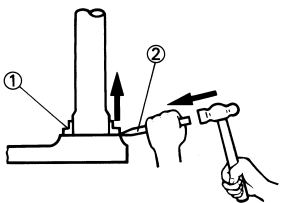

354-007

REMOVING THE BEARING RACE

- Remove:
 - Bearing race "1"
 - Remove the bearing race using long rod "2" and the hammer.

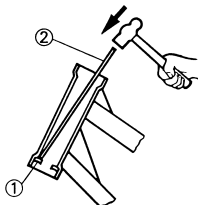

354-005

CHECKING THE STEERING STEM

- Inspect:
 - Steering stem "1"
 - Bend/damage → Replace.

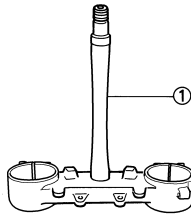

CHECKING THE BEARING AND BEARING RACE

- Wash the bearings and bearing races with a solvent.
- Inspect:
 - Bearing "1"
 - Bearing race
 - Pitting/damage → Replace bearings and bearing races as a set.
 - Install the bearing in the bearing races. Spin the bearings by hand. If the bearings hang up or are not smooth in their operation in the bearing races, replace bearings and bearing races as a set.

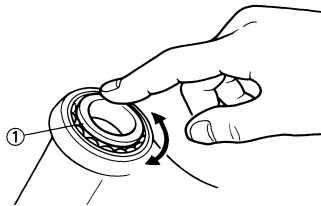

INSTALLING THE LOWER BRACKET

- Install:
 - Lower bearing "1"

TIP

Apply the lithium soap base grease on the dust seal lip and bearing inner circumference.

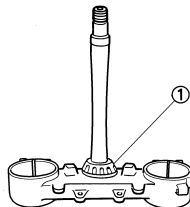

- Install:
 - Bearing race
 - Upper bearing "1"
 - Bearing race cover "2"

TIP

Apply the lithium soap base grease on the bearing and bearing race cover lip.

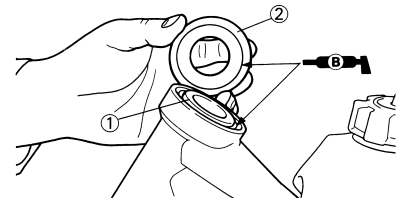

- Install:
 - Lower bracket "1"

TIP

Apply the lithium soap base grease on the bearing, the portion "a" and thread of the steering stem.

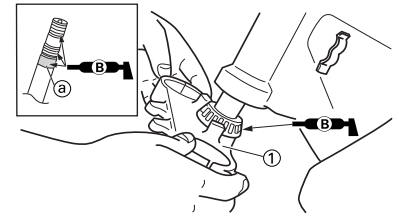

- Install:
 - Steering ring nut "1"



Steering ring nut:
7 Nm (0.7 m•kg, 5.1 ft•lb)

Tighten the steering ring nut using the steering nut wrench "2". Refer to "CHECKING AND ADJUSTING THE STEERING HEAD" section in the CHAPTER 3.

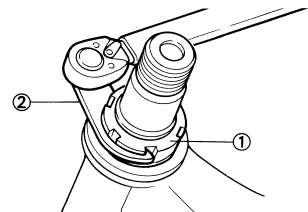

- Check the steering stem by turning it lock to lock. If there is any binding, remove the steering stem assembly and inspect the steering bearings.

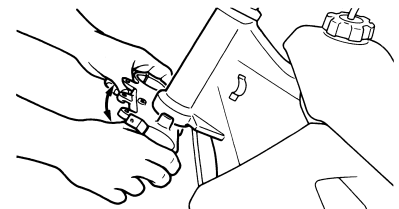

6. Install:

- Washer "1"

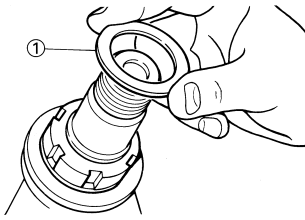

7. Install:

- Front fork "1"
- Upper bracket "2"

TIP

- Temporarily tighten the pinch bolts (lower bracket).
- Do not tighten the pinch bolts (upper bracket) yet.

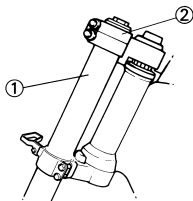

8. Install:

- Washer "1"
- Steering stem nut "2"

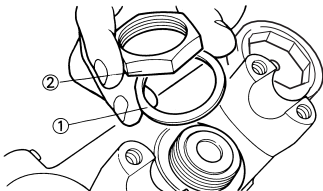
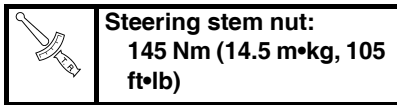

9. After tightening the nut, check the steering for smooth movement. If not, adjust the steering by loosening the steering ring nut little by little.

10. Adjust:

- Front fork top end "a"

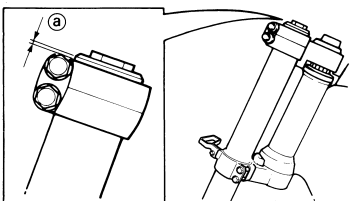
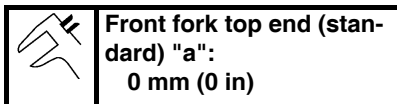

11. Tighten:

- Pinch bolt (upper bracket) "1"

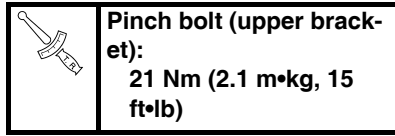

- Pinch bolt (lower bracket) "2"

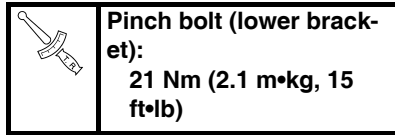

NOTICE

Tighten the lower bracket to specified torque. If torqued too much, it may cause the front fork to malfunction.

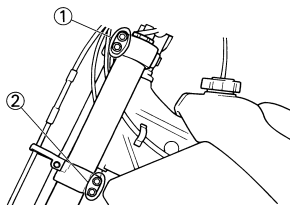

SWINGARM

REMOVING THE SWINGARM

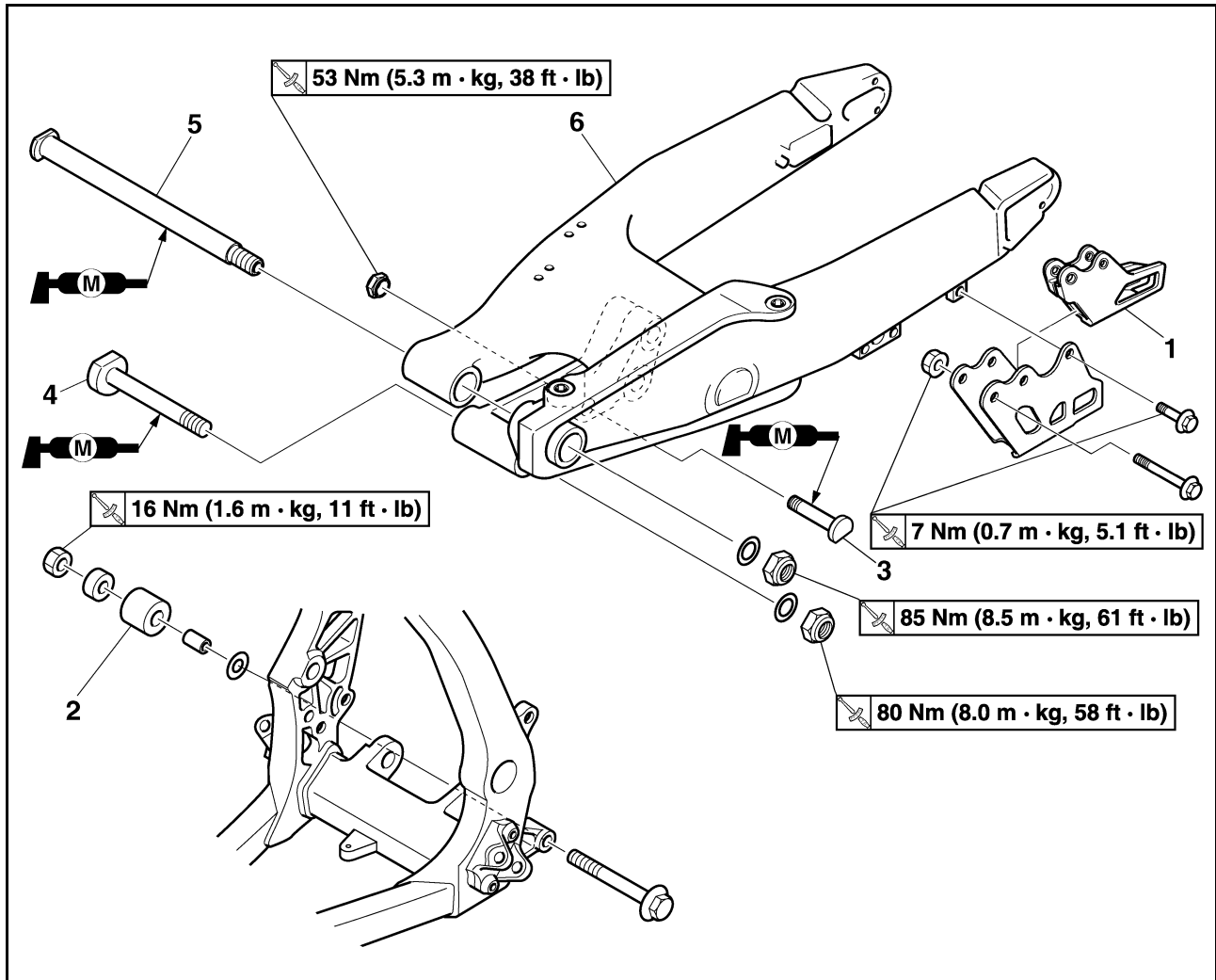

Order	Part name	Q'ty	Remarks
	Hold the machine by placing the suitable stand under the engine.		Refer to "HANDLING NOTE".
	Brake hose holder		Refer to "FRONT BRAKE AND REAR BRAKE" section.
	Rear brake caliper		Refer to "FRONT BRAKE AND REAR BRAKE" section.
	Bolt (brake pedal)		Shift the brake pedal backward.
	Drive chain		
1	Drive chain support	1	
2	Lower chain tensioner	1	
3	Bolt (rear shock absorber-relay arm)	1	Hold the swingarm.
4	Bolt (connecting rod)	1	
5	Pivot shaft	1	
6	Swingarm	1	

DISASSEMBLING THE SWINGARM

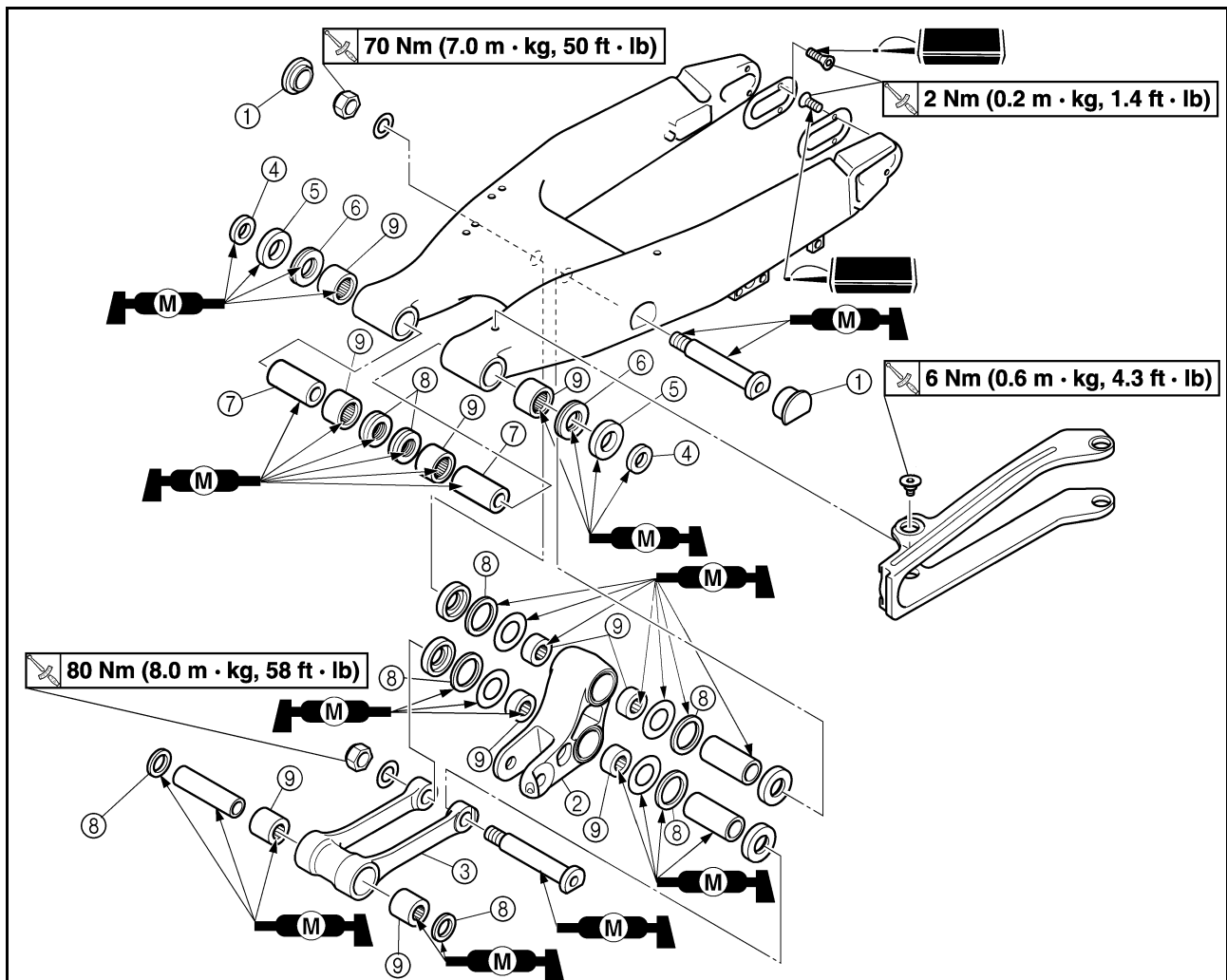

Order	Part name	Q'ty	Remarks
1	Cap	2	Refer to removal section.
2	Relay arm	1	
3	Connecting rod	1	
4	Collar	2	
5	Oil seal	2	
6	Thrust bearing	2	
7	Bushing	2	
8	Oil seal	8	
9	Bearing	10	Refer to removal section.

HANDLING NOTE

⚠ WARNING

Support the machine securely so there is no danger of it falling over.

REMOVING THE CAP

- Remove:
 - Left cap "1"

TIP

Remove with a slotted-head screwdriver inserted under the mark "a" on the left cap.

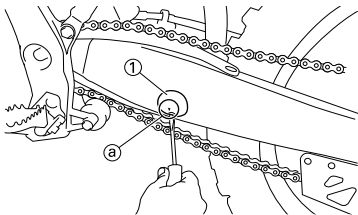

REMOVING THE BEARING

- Remove:
 - Bearing "1"

TIP

Remove the bearing by pressing its outer race.

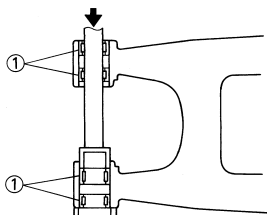

CHECKING THE SWINGARM

- Inspect:
 - Bearing "1"
 - Bushing "2"

Free play exists/unsmooth revolution/rust → Replace bearing and bushing as a set.
- Inspect:
 - Oil seal "3"

Damage → Replace.

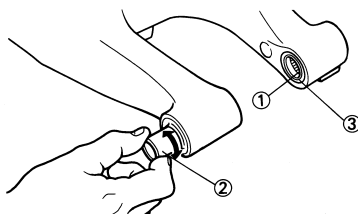

CHECKING THE RELAY ARM

- Inspect:
 - Bearing "1"
 - Collar "2"

Free play exists/unsmooth revolution/rust → Replace bearing and collar as a set.

- Inspect:
 - Oil seal "3"

Damage → Replace.

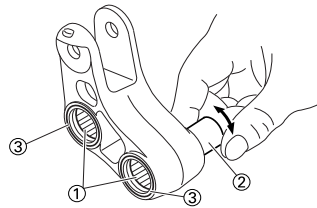

CHECKING THE CONNECTING ROD

- Inspect:
 - Bearing "1"
 - Collar "2"

Free play exists/unsmooth revolution/rust → Replace bearing and collar as a set.
- Inspect:
 - Oil seal "3"

Damage → Replace.

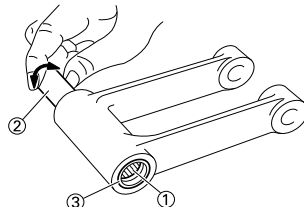

INSTALLING THE BEARING AND OIL SEAL

- Install:
 - Bearing "1"
 - Oil seal "2"

To swingarm.

TIP

- Apply the molybdenum disulfide grease on the bearing when installing.
- Install the bearing by pressing it on the side having the manufacturer's marks or numbers.
- First install the outer and then the inner bearings to a specified depth from inside.

	Installed depth of bearings:
	Outer "a": 0 mm (0 in) Inner "b": 6.5 mm (0.26 in)

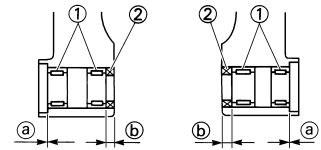
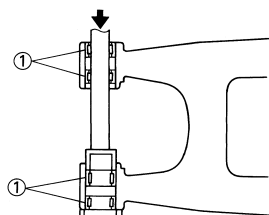

- Install:
 - Bearing "1"
 - Washer "2"
 - Oil seal "3"

To relay arm.

TIP

- Apply the molybdenum disulfide grease on the bearing when installing.
- Install the bearing by pressing it on the side having the manufacturer's marks or numbers.
- Apply the molybdenum disulfide grease on the washer.

	Installed depth of bearings "a":
	0 mm (0 in)

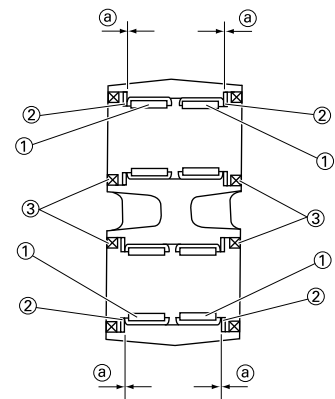

- Install:
 - Bearing "1"
 - Oil seal "2"

To connecting rod.

TIP

- Apply the molybdenum disulfide grease on the bearing when installing.
- Install the bearing by pressing it on the side having the manufacturer's marks or numbers.

	Installed depth of bearing "a":
	0 mm (0 in)

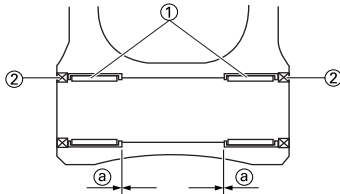

INSTALLING THE SWINGARM

1. Install:

- Bushing "1"
 - Thrust bearing "2"
 - Oil seal "3"
 - Collar "4"
- To swingarm "5".

TIP

Apply the molybdenum disulfide grease on the bushings, thrust bearings, oil seal lips and contact surfaces of the collar and thrust bearing.

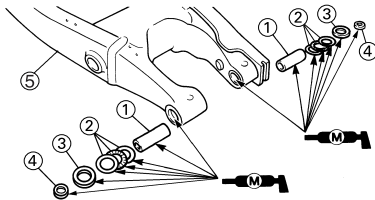

2. Install:

- Collar "1"
 - Washer "2"
- To relay arm "3".

TIP

Apply the molybdenum disulfide grease on the collars and oil seal lips.

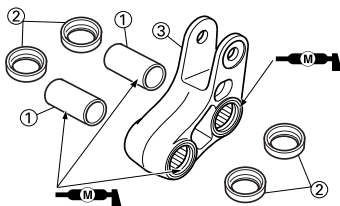

3. Install:

- Collar "1"
- To connecting rod "2".

TIP

Apply the molybdenum disulfide grease on the collar and oil seal lips.

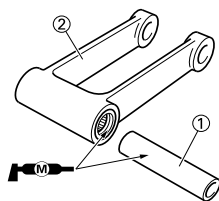

4. Install:

- Connecting rod "1"
- Bolt (connecting rod) "2"
- Washer "3"
- Nut (connecting rod) "4"



Nut (connecting rod):
80 Nm (8.0 m•kg, 58 ft•lb)

To relay arm "5".

TIP

Apply the molybdenum disulfide grease on the bolt.

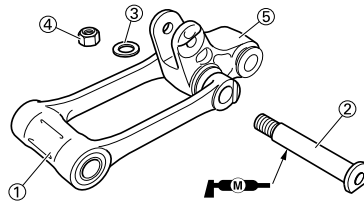

5. Install:

- Relay arm "1"
 - Bolt (relay arm) "2"
 - Washer "3"
 - Nut (relay arm) "4"
- To swingarm.

TIP

- Apply the molybdenum disulfide grease on the bolt circumference and threaded portion.
- Do not tighten the nut yet.

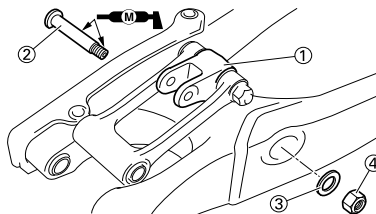

6. Install:

- Swingarm "1"
- Pivot shaft "2"



Pivot shaft:
85 Nm (8.5 m•kg, 61 ft•lb)

TIP

- Apply the molybdenum disulfide grease on the pivot shaft.
- Insert the pivot shaft from right side.

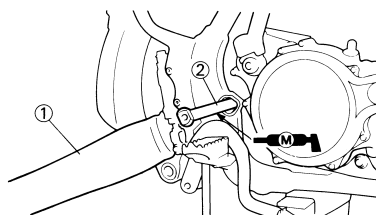

7. Check:

- Swingarm side play "a"
Free play exists → Replace thrust bearing.
- Swingarm up and down movement "b"
Unsmooth movement/binding/rough spots → Grease or replace bearings, bushings and collars.

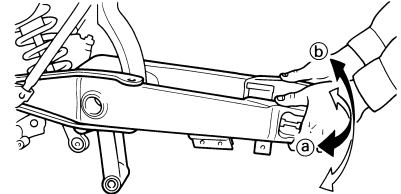

8. Install:

- Bolt (connecting rod) "1"
- Washer "2"
- Nut (connecting rod) "3"

TIP

- Apply the molybdenum disulfide grease on the bolt.
- Do not tighten the nut yet.

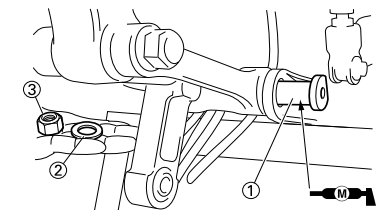

9. Install:

- Bolt (rear shock absorber-relay arm) "1"
- Nut (rear shock absorber-relay arm) "2"



Nut (rear shock absorber-relay arm):
53 Nm (5.3 m•kg, 38 ft•lb)

TIP

Apply the molybdenum disulfide grease on the bolt.

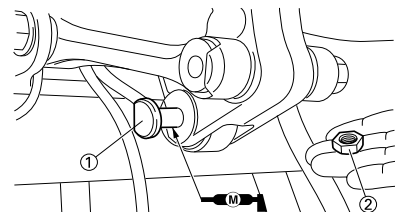

10. Tighten:

- Nut (connecting rod) "1"

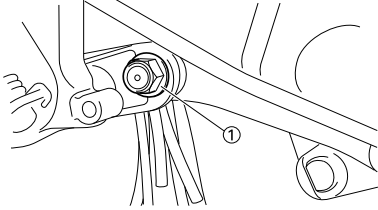
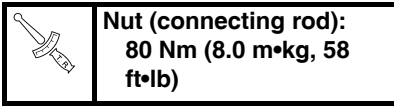

11. Tighten:

- Nut (relay arm) "1"

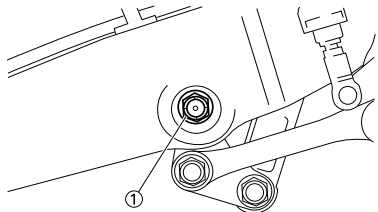
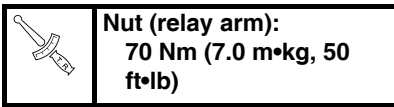

12. Install:

- Cap "1"

TIP

Install the right cap with its mark "a" facing forward.

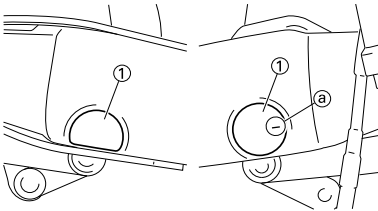

13. Install:

- Bolt (lower chain tensioner) "1"
- Washer "2"
- Collar "3"
- Lower chain tensioner "4"
- Nut (lower chain tensioner) "5"

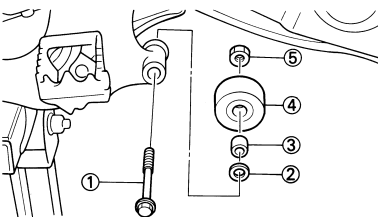
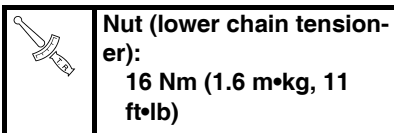

14. Install:

- Drive chain support "1"
- Drive chain support cover "2"
- Bolt (drive chain support [L = 50 mm (1.97 in)]) "3"
- Nut (drive chain support) "4"

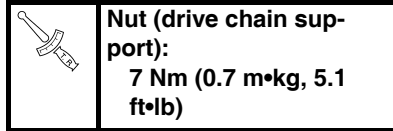

- Bolt (drive chain support cover [L = 10 mm (0.39 in)]) "5"

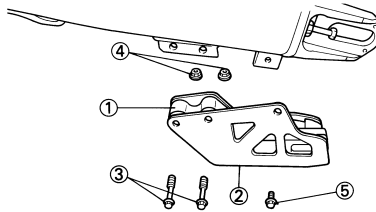
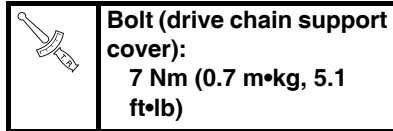

REAR SHOCK ABSORBER

REAR SHOCK ABSORBER

REMOVING THE REAR SHOCK ABSORBER

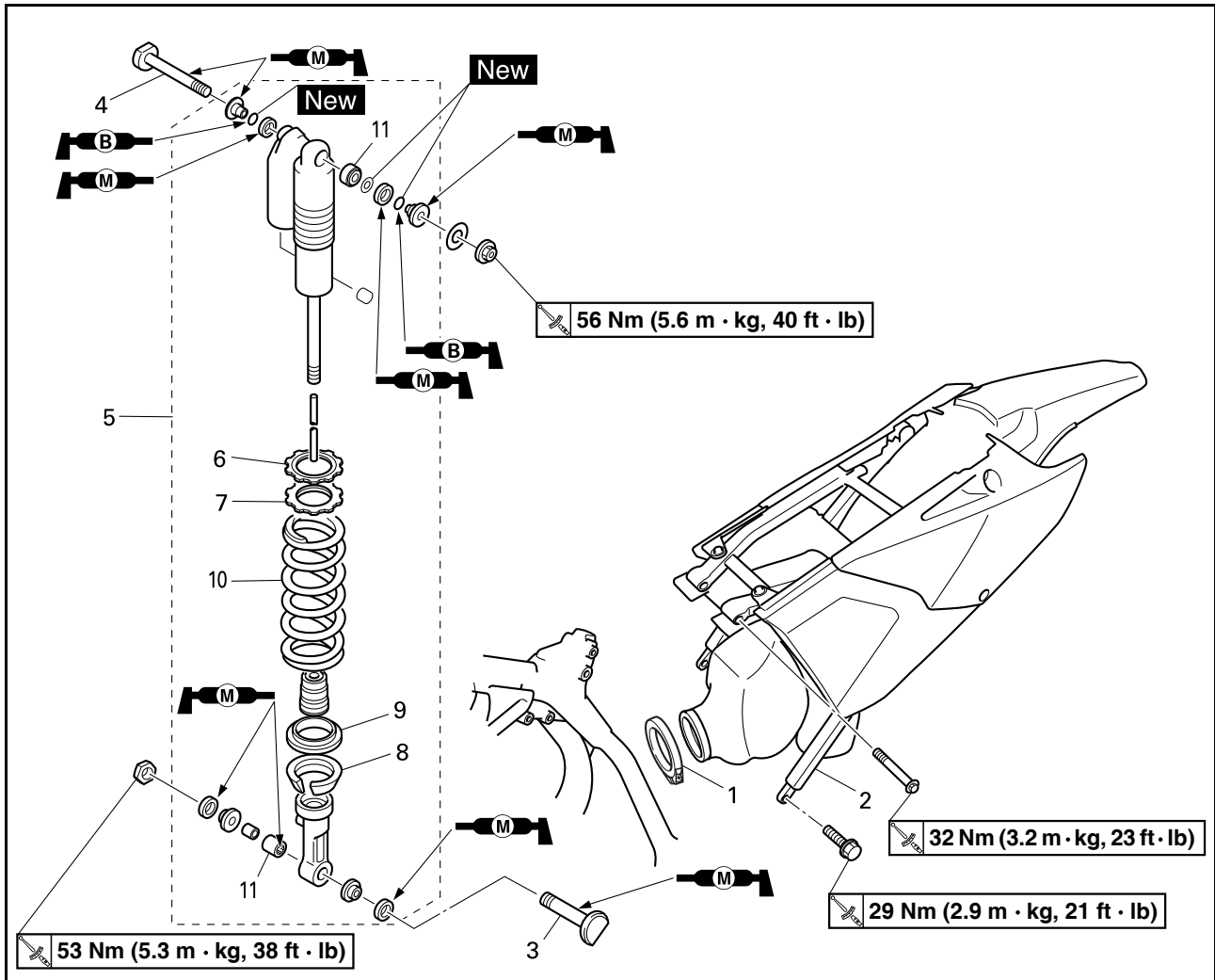

Order	Part name	Q'ty	Remarks
	Hold the machine by placing the suitable stand under the engine.		Refer to "HANDLING NOTE".
	Seat		Refer to "SEAT, FUEL TANK AND SIDE COVERS" section in the CHAPTER 4.
	Silencer		Refer to "EXHAUST PIPE AND SILENCER" section in the CHAPTER 4.
1	Clamp (air filter joint)	1	Only loosening.
2	Rear frame	1	
3	Bolt (rear shock absorber-relay arm)	1	Hold the swingarm.
4	Bolt (rear shock absorber-frame)	1	
5	Rear shock absorber	1	
6	Locknut	1	Only loosening.
7	Adjuster	1	Only loosening.
8	Lower spring guide	1	
9	Upper spring guide	1	
10	Spring (rear shock absorber)	1	
11	Bearing	2	Refer to removal section.

REAR SHOCK ABSORBER

HANDLING NOTE

⚠ WARNING

- Support the machine securely so there is no danger of it falling over.
- This rear shock absorber is provided with a separate type tank filled with high-pressure nitrogen gas. To prevent the danger of explosion, read and understand the following information before handling the shock absorber. The manufacturer can not be held responsible for property damage or personal injury that may result from improper handling.
- Never tamper or attempt to disassemble the cylinder or the tank.
- Never throw the rear shock absorber into an open flame or other high heat. The rear shock absorber may explode as a result of nitrogen gas expansion and/or damage to the hose.
- Be careful not to damage any part of the gas tank. A damaged gas tank will impair the damping performance or cause a malfunction.
- Take care not to scratch the contact surface of the piston rod with the cylinder; or oil could leak out.
- Never attempt to remove the plug at the bottom of the nitrogen gas tank. It is very dangerous to remove the plug.
- When scrapping the rear shock absorber, follow the instructions on disposal.

NOTES ON DISPOSAL (YAMAHA DEALERS ONLY)

Before disposing the rear shock absorber, be sure to extract the nitrogen gas from valve "1". Wear eye protection to prevent eye damage from escaping gas and/or metal chips.

⚠ WARNING

To dispose of a damaged or worn-out rear shock absorber, take the unit to your Yamaha dealer for this disposal procedure.

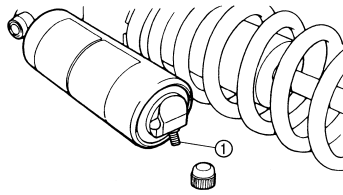

REMOVING THE BEARING

1. Remove:
 - Stopper ring (upper bearing) "1"

TIP

Press in the bearing while pressing its outer race and remove the stopper ring.

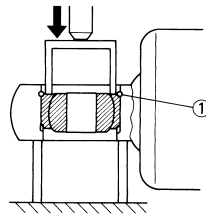

2. Remove:
 - Upper bearing "1"

TIP

Remove the bearing by pressing its outer race.

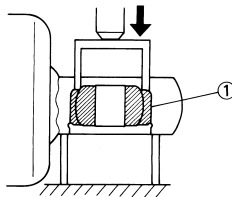

3. Remove:
 - Lower bearing "1"

TIP

Remove the bearing by pressing its outer race.

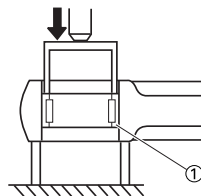

CHECKING THE REAR SHOCK ABSORBER

1. Inspect:
 - Damper rod "1"
 - Bends/damage → Replace rear shock absorber assembly.

- Shock absorber "2"
 - Oil leaks → Replace rear shock absorber assembly.
 - Gas leaks → Replace rear shock absorber assembly.
- Spring "3"
 - Damage → Replace spring.
 - Fatigue → Replace spring.
 - Move spring up and down.
- Spring guide "4"
 - Wear/damage → Replace spring guide.
- Bearing "5"
 - Free play exists/unsmooth revolution/rust → Replace.

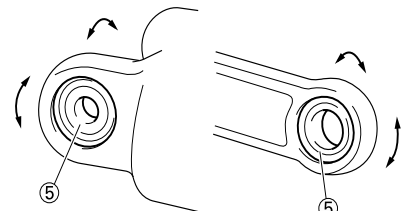
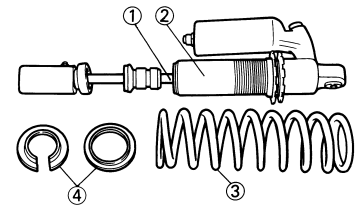

INSTALLING THE BEARING

1. Install:
 - Upper bearing "1"

TIP

Install the bearing parallel until the stopper ring groove appears by pressing its outer race.

NOTICE

Do not apply the grease on the bearing outer race because it will wear the rear shock absorber surface on which the bearing is press fitted.

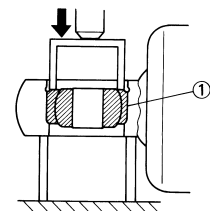

REAR SHOCK ABSORBER

2. Install:

- Stopper ring (upper bearing) "1"
New

TIP

After installing the stopper ring, push back the bearing until it contacts the stopper ring.

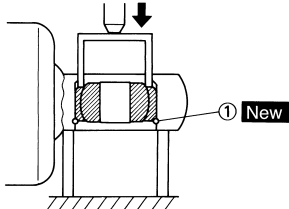

3. Install:

- Lower bearing "1"

TIP

Install the bearing by pressing it on the side having the manufacture's marks or numbers.

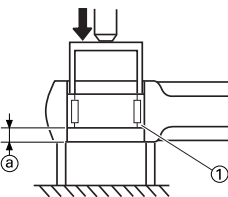
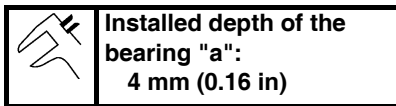

INSTALLING THE SPRING (REAR SHOCK ABSORBER)

1. Install:

- Spring "1"
- Upper spring guide "2"
- Lower spring guide "3"

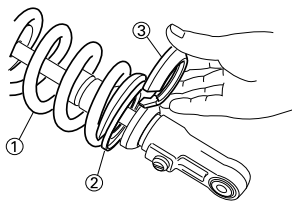

2. Tighten:

- Adjuster "1"

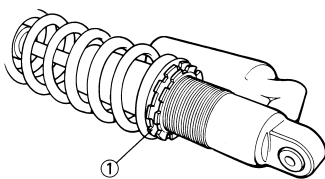

3. Adjust:

- Spring length (installed)
Refer to "ADJUSTING THE REAR SHOCK ABSORBER SPRING PRELOAD" section in the CHAPTER 3.

4. Tighten:

- Locknut "1"

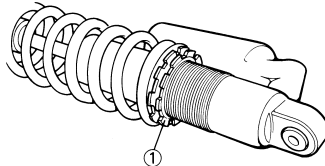

INSTALLING THE REAR SHOCK ABSORBER

1. Install:

- Dust seal "1"
- O-ring "2" **New**
- Collar "3"

TIP

- Apply the molybdenum disulfide grease on the dust seal lips and collars.
- Apply the lithium soap base grease on the O-rings.

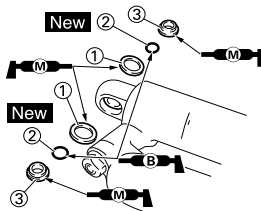

2. Install:

- Bushing "1"
- Collar "2"
- Dust seal "3"

TIP

- Apply the molybdenum disulfide grease on the bearing and dust seal lips.
- Install the dust seals with their lips facing inward.

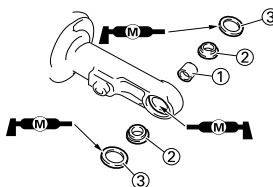

3. Install:

- Rear shock absorber

4. Install:

- Bolt (rear shock absorber-frame) "1"
- Washer "2"
- Nut (rear shock absorber-frame) "3"



Nut (rear shock absorber-frame):

56 Nm (5.6 m•kg, 40 ft•lb)

TIP

Apply the molybdenum disulfide grease on the bolt.

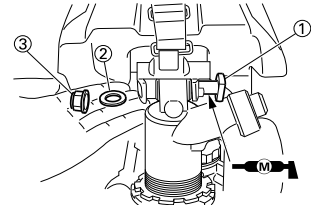

5. Install:

- Bolt (rear shock absorber-relay arm) "1"
- Nut (rear shock absorber-relay arm) "2"



Nut (rear shock absorber-relay arm):

53 Nm (5.3 m•kg, 38 ft•lb)

TIP

Apply the molybdenum disulfide grease on the bolt.

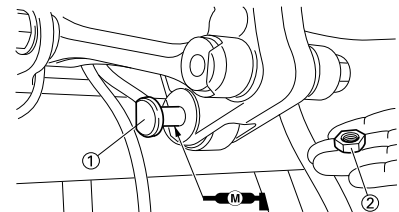

6. Install:

- Rear frame "1"
- Bolt [rear frame (upper)] "2"



Bolt [rear frame (upper)]:

32 Nm (3.2 m•kg, 23 ft•lb)

- Bolt [rear frame (lower)] "3"



Bolt [rear frame (lower)]:

29 Nm (2.9 m•kg, 21 ft•lb)

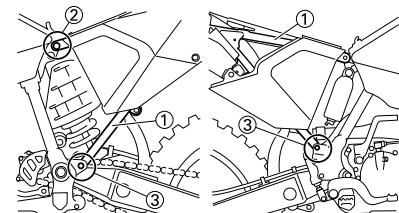

REAR SHOCK ABSORBER

7. Tighten:

- Bolt (air filter joint) "1"

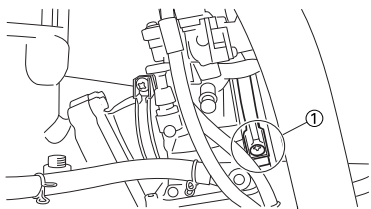

ELECTRICAL COMPONENTS AND WIRING DIAGRAM

ELECTRICAL

TIP

This section is intended for those who have basic knowledge and skill concerning the servicing of Yamaha motorcycles (e.g., Yamaha dealers, service engineers, etc.). Those who have little knowledge and skill concerning servicing are requested not to undertake inspection, adjustment, disassembly, or reassembly only by reference to this manual. It may lead to servicing trouble and mechanical damage.

ELECTRICAL COMPONENTS AND WIRING DIAGRAM

ELECTRICAL COMPONENTS

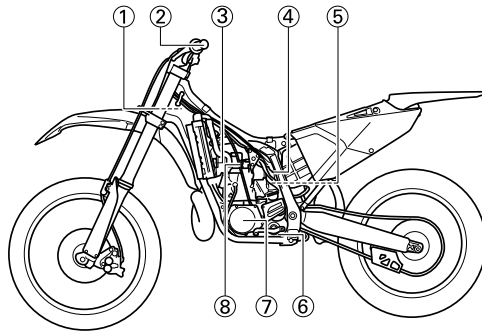

- | | | |
|-----------------------|-----------------------------|----------------|
| 1. CDI unit | 4. Throttle position sensor | 7. CDI magneto |
| 2. Engine stop switch | 5. Solenoid valve | 8. Spark plug |
| 3. Ignition coil | 6. Neutral switch | |

WIRING DIAGRAM

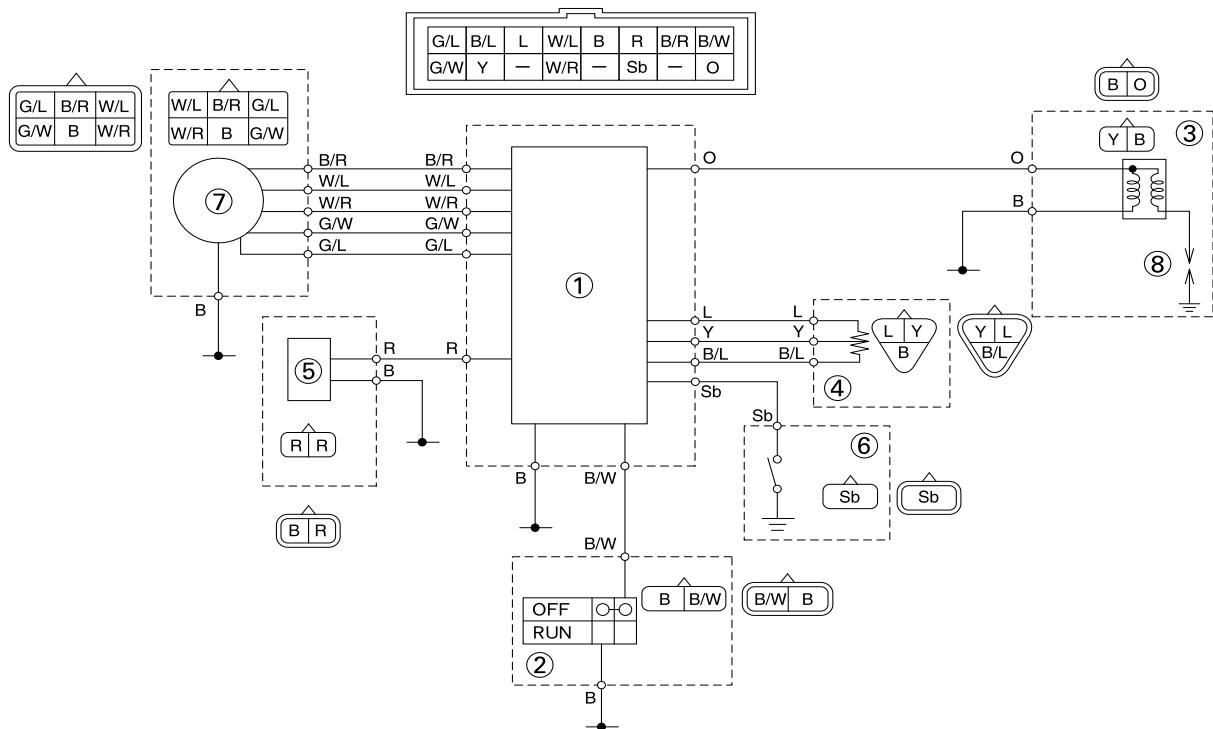

1. CDI unit
2. Engine stop switch
3. Ignition coil
4. Throttle position sensor
5. Solenoid valve
6. Neutral switch
7. CDI magneto
8. Spark plug

COLOR CODE

- | | |
|-----|------------|
| B | Black |
| L | Blue |
| O | Orange |
| R | Red |
| Sb | Sky blue |
| Y | Yellow |
| B/L | Black/Blue |

- | | |
|-----|-------------|
| B/R | Black/Red |
| B/W | Black/White |
| G/L | Green/Blue |
| G/W | Green/White |
| W/L | White/Blue |
| W/R | White/Red |

IGNITION SYSTEM

INSPECTION STEPS

Use the following steps for checking the possibility of the malfunctioning engine being attributable to ignition system failure and for checking the spark plug which will not spark.

Spark gap test	Spark →	*Clean or replace spark plug.
No spark ↓		
Check entire ignition system for connection.	No good →	Repair or replace.
OK ↓		
Check engine stop switch.	No good →	Replace.
OK ↓		
Check ignition coil. (primary coil and secondary coil)	No good →	Replace.
OK ↓		
Check spark plug cap.	No good →	Replace.
OK ↓		
Check CDI magneto. (pickup coil and charging coil)	No good →	Replace.
OK ↓		
Check neutral switch.	No good →	Repair or replace.
OK ↓		
Replace CDI unit.		

*marked: Only when the ignition checker is used.

TIP

- Remove the following parts before inspection.
 1. Seat
 2. Fuel tank
- Use the following special tools in this inspection.

	Dynamic spark tester:
	YM-34487
	Ignition checker:
	90890-06754
	Pocket tester:
	YU-03112-C/90890-03112

SPARK GAP TEST

1. Disconnect the spark plug cap from spark plug.
2. Connect the dynamic spark tester "1" (ignition checker "2") as shown.
 - Ignition coil "3"
 - Spark plug "4"

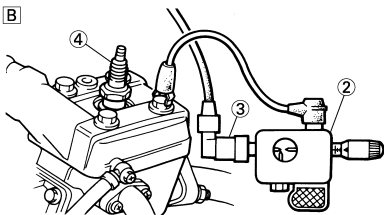
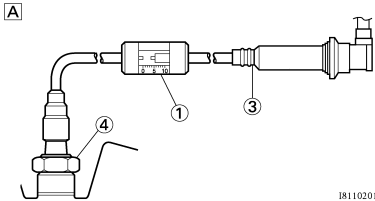

- A. For USA and CDN
B. Except for USA and CDN

3. Kick the kickstarter lever.
4. Check the ignition spark gap.
5. Start engine, and increase spark gap until misfire occurs. (for USA and CDN only)

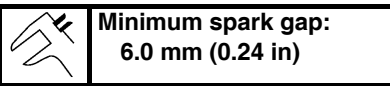

CHECKING THE COUPLERS, LEADS AND IGNITION COIL CONNECTION

1. Check:
 - Couplers and leads connection
 - Rust/dust/looseness/short-circuit → Repair or replace.

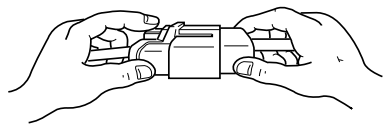

CHECKING THE ENGINE STOP SWITCH

1. Inspect:
 - Engine stop switch conduction

Tester (+) lead → Black/White lead "1"
Tester (-) lead → Black lead "2"

	Result Conductive (while the engine stop switch is pushed)
--	--

Not conductive while it is pushed → Replace.
Conductive while it is freed → Replace.

TIP
Set the tester selection position to " $\Omega \times 1$ ".

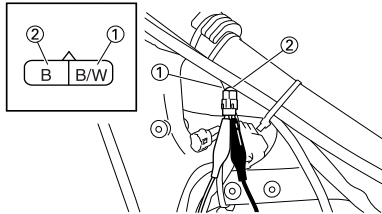

CHECKING THE IGNITION COIL

1. Inspect:
 - Primary coil resistance
 - Out of specification → Replace.

Tester (+) lead → Yellow lead "1"
Tester (-) lead → Black lead "2"

	Primary coil resistance	Tester selector position
	0.20–0.30 Ω at 20 °C (68 °F)	$\Omega \times 1$

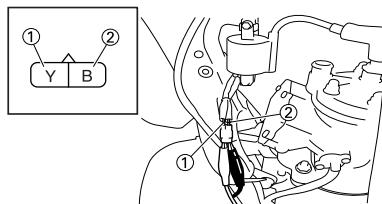

2. Inspect:
 - Secondary coil resistance
 - Out of specification → Replace.

Tester (+) lead → Spark plug lead "1"
Tester (-) lead → Yellow lead "2"

	Secondary coil resistance	Tester selector position
	9.52–14.28 k Ω at 20 °C (68 °F)	k $\Omega \times 1$

TIP
• Remove the spark plug cap by turning it counterclockwise and inspect.
• Install the spark plug cap by turning it clockwise until it is tight.

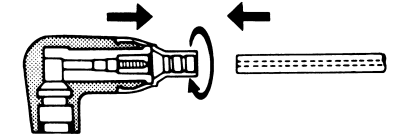
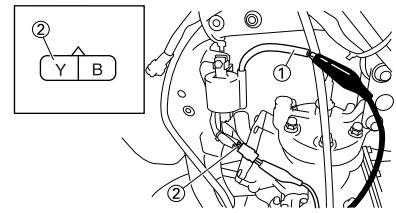

CHECKING THE SPARK PLUG CAP

1. Inspect:
 - Spark plug cap
 - Loose connection → Tighten.
 - Deteriorated/damaged → Replace.
 - Spark plug cap resistance
 - Out of specification → Replace.

Tester (+) lead → Spark plug lead terminal "1"
Tester (-) lead → Spark plug terminal "2"

	Spark plug cap resistance	Tester selector position
	5.00 k Ω at 20 °C (68 °F)	k $\Omega \times 1$

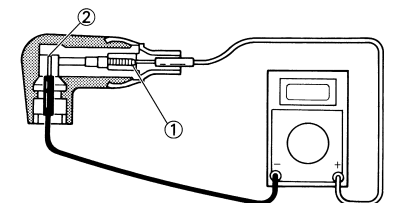

CHECKING THE CDI MAGNETO

1. Inspect:
 - Pickup coil resistance
 - Out of specification → Replace.

Tester (+) lead → White/Red lead "1"
Tester (-) lead → White/Blue lead "2"

	Pickup coil resistance	Tester selector position
	248.0–372.0 Ω at 20 °C (68 °F)	$\Omega \times 100$

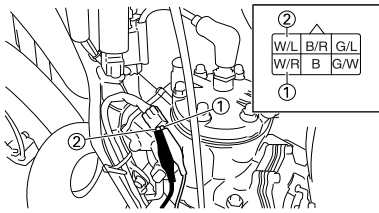

2. Inspect:
- Charging coil 1 resistance
Out of specification → Replace.

Tester (+) lead → Black/Red lead "1"
Tester (-) lead → Black lead "2"

	Charging coil 1 resistance	Tester selector position
	720.0–1,080.0 Ω at 20 °C (68 °F)	Ω × 100

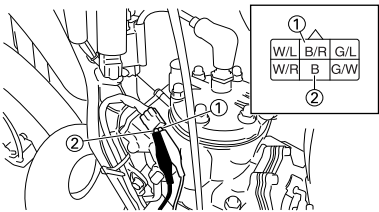

3. Inspect:
- Charging coil 2 resistance
Out of specification → Replace.

Tester (+) lead → Green/Blue lead "1"
Tester (-) lead → Green/White lead "2"

	Charging coil 2 resistance	Tester selector position
	44.0–66.0 Ω at 20 °C (68 °F)	Ω × 10

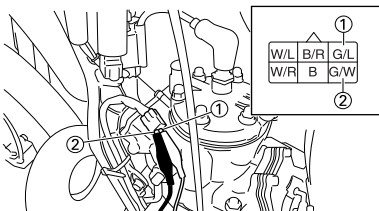

CHECKING THE NEUTRAL SWITCH

1. Inspect:
- Neutral switch conduction

Tester (+) lead → Sky blue lead "1"
Tester (-) lead → Ground "2"

	Result
	Conductive (while gear is in neutral)

Not conductive while it is in neutral → Replace.
 Conductive while it is engaged → Replace.

TIP _____
 Set the tester selection position to "Ω × 1".

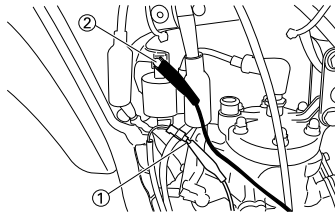

CHECKING THE CDI UNIT

Check all electrical components. If no fault is found, replace the CDI unit. Then check the electrical components again.

SOLENOID VALVE SYSTEM

SOLENOID VALVE SYSTEM

INSPECTION STEPS

If the solenoid valve will not operate, use the following inspection steps.

Check each couplers and wire connection.	No good →	Repair or replace.
OK ↓		
Check solenoid valve. (Check solenoid valve operation. Solenoid valve coil)	No good →	Replace.
OK ↓		
* Check CDI magneto. (Source coil)	No good →	Replace.
OK ↓		
Replace CDI unit.		

***marked: Refer to "IGNITION SYSTEM" section.**

TIP

- Remove the following parts before inspection.
 1. Seat
 2. Fuel tank
- Use 12V battery in this inspection.
- Use the following special tools in this inspection.

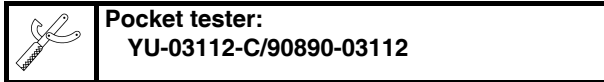

CHECKING THE COUPLERS AND LEADS CONNECTION

1. Check:
 - Couplers and leads connection
Rust/ Dust/ Looseness/Short-circuit → Repair or replace.

CHECKING THE SOLENOID VALVE OPERATION

1. Disconnect the solenoid valve coupler.
2. Connect 12V battery to the solenoid valve coupler.

Tester (+) lead → Red lead "1"
Tester (-) lead → Red lead "2"

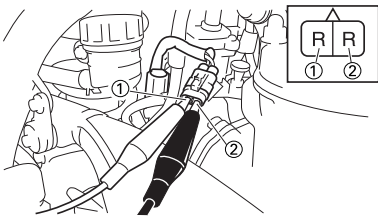

3. Inspect:
 - Solenoid valve "1"
No click when connecting the battery → Replace.

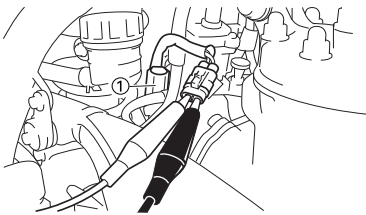

CHECKING THE SOLENOID VALVE COIL

1. Inspect:
 - Solenoid valve coil resistance
Out of specification → Replace.

Tester (+) lead → Red lead "1"
Tester (-) lead → Red lead "2"

	Solenoid resistance	Tester selector position
	22.8–27.8 Ω at 20°C (68 °F)	Ω × 10

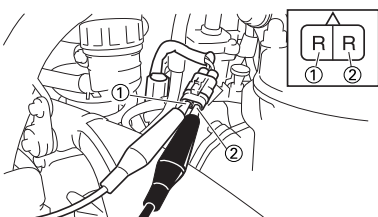

THROTTLE POSITION SENSOR SYSTEM

THROTTLE POSITION SENSOR SYSTEM

INSPECTION STEPS

If the throttle position sensor will not operate, use the following inspection steps.

Check entire ignition system for connection.	No good →	Repair or replace.
OK ↓		
Check throttle position sensor. (Throttle position sensor coil)	No good →	Replace.
OK ↓		
*Check CDI magneto. (Source coil)	No good →	Replace.
OK ↓		
Check CDI unit. (Throttle position sensor input voltage)	No good →	Replace.

*marked: Refer to "IGNITION SYSTEM" section.

TIP

- Remove the following parts before inspection.
 1. Seat
 2. Fuel tank
- Use the following special tools in this inspection.

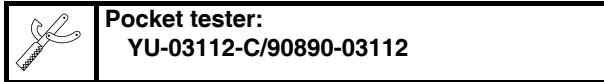

THROTTLE POSITION SENSOR SYSTEM

HANDLING NOTE

NOTICE

Do not loosen the screw (throttle position sensor) "1" except when changing the throttle position sensor due to failure because it will cause a drop in engine performance.

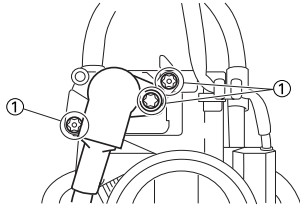

CHECKING THE COUPLERS AND LEADS CONNECTION

1. Check:
 - Couplers and leads connection
 - Rust/dust/looseness/short-circuit → Repair or replace.

CHECKING THE THROTTLE POSITION SENSOR COIL

1. Remove:
 - Carburetor
 - Mixing chamber top
 Refer to "CARBURETOR AND REED VALVE" section in the CHAPTER 4.
2. Inspect:
 - Throttle position sensor coil resistance
 - Out of specification → Replace.

Tester (+) lead → Blue lead "1"
Tester (-) lead → Black lead "2"

	Throttle position sensor coil resistance	Tester selector position
	4–6 kΩ at 20°C (68°F)	kΩ × 1

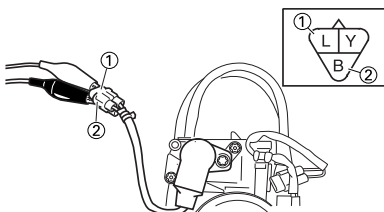

3. Inspect:
 - Throttle position sensor coil variable resistance
 - Check that the resistance in increased as the lever "1" is moved from the full close position to the full open position.
 - Out of specification → Replace.

Tester (+) lead → Yellow lead "2"
Tester (-) lead → Black lead "3"

	Throttle position sensor coil variable resistance	Tester selector position
Full closed	Full opened	kΩ × 1
0–2 kΩ at 20°C (68°F)	4–6 kΩ at 20°C (68°F)	

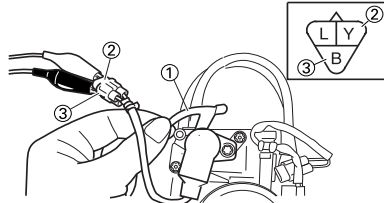

CHANGING AND ADJUSTING THE THROTTLE POSITION SENSOR

1. Remove:
 - Carburetor
 - Mixing chamber top
 Refer to "CARBURETOR AND REED VALVE" section in the CHAPTER 4.
2. Remove:
 - Screw (throttle position sensor) "1"
 - Throttle position sensor "2"

TIP

Loosen the screw (throttle position sensor) using the T25 bit.

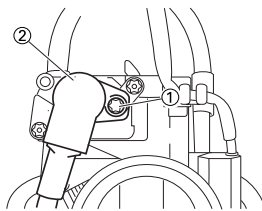

3. Replace:
 - Throttle position sensor
4. Install:
 - Throttle position sensor "1"
 - Screw (throttle position sensor) "2"

TIP

- Align the slot "a" in the throttle position sensor with the projection "b" on the carburetor while the lever "3" is held down.
- Temporarily tighten the screw (throttle position sensor).

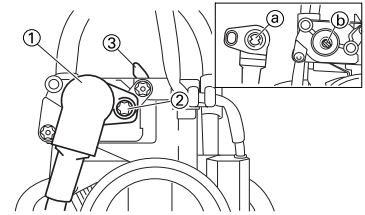

5. Install:
 - Mixing chamber top
 - Carburetor
 Refer to "CARBURETOR AND REED VALVE" section in the CHAPTER 4.
6. Adjust:
 - Idle speed for throttle position sensor adjustment

Adjustment steps:

- a. Set the digital tachometer to the high tension cord.
- b. Turn the throttle stop screw "1" until the specified idle speed. Refer to "ADJUSTING THE ENGINE IDLING SPEED" section in the CHAPTER 3.

 Idle speed for TPS adjustment:
1,700–1,900 rpm

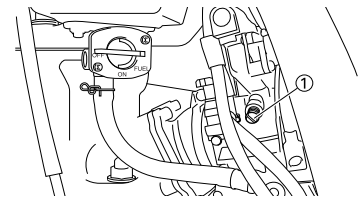

7. Insert the thin electric conductors "2" (lead wire) into the throttle position sensor coupler "1", as shown, and connect the tester to them.

Tester (+) lead → Yellow lead "3"
Tester (-) lead → Black lead "4"

NOTICE

- Do not insert the electric conductors more than required because it may reduce the waterproof function of the coupler.
- Make sure that a short-circuit does not develop between the terminals because it may cause damage to electrical components.

THROTTLE POSITION SENSOR SYSTEM

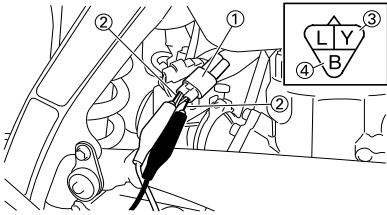

8. Start the engine.
9. Adjust:
 - Throttle position sensor output voltage



Adjustment steps:

- a. Adjust the installation angle of the throttle position sensor "1" to obtain the specified output voltage.

	Throttle position sensor output voltage	Tester selector position
	0.5–0.7 V	DCV-20

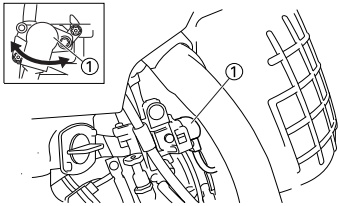

10. Put the aligning marks "a" on the throttle position sensor and carburetor.

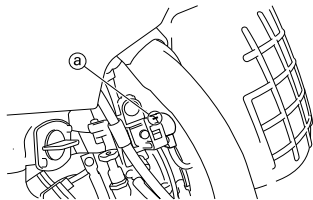

11. Stop the engine.
12. Remove:
 - Carburetor
 Refer to "CARBURETOR AND REED VALVE" section in the CHAPTER 4.

13. Tighten:
 - Screw (throttle position sensor "1")

TIP

Tighten the screws (throttle position sensor) using the T20 bit (tamper resistant fastener type) by aligning the marks "a" that were put before removal.

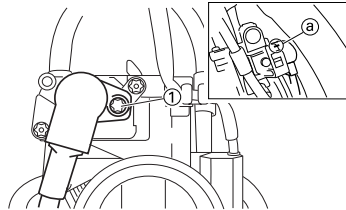

14. Install:
 - Carburetor
 Refer to "CARBURETOR AND REED VALVE" section in the CHAPTER 4.

CHECKING THE THROTTLE POSITION SENSOR INPUT VOLTAGE

1. Disconnect the throttle position sensor coupler.
2. Start the engine.
3. Inspect:
 - Throttle position sensor input voltage
 Out of specification → Replace the CDI unit.

Tester (+) lead → Blue lead "1"
Tester (-) lead → Black/Blue lead "2"

	Throttle position sensor input voltage	Tester selector position
	4–6 V	DCV-20



TUNING ENGINE

CARBURETOR SETTING

- The role of fuel is to cool the engine, and in the case of a 2-stroke engine, to lubricate the engine in addition to power generation. Accordingly, if a mixture of air and fuel is too lean, abnormal combustion will occur, and engine seizure may result. If the mixture is too rich, spark plugs will get wet with oil, thus making it impossible to bring the engine into full play or if the worst comes to the worst, the engine may stall.
- The richness of the air-fuel mixture required for the engine will vary with atmospheric conditions of the day and therefore, the settings of the carburetor must be properly suited to the atmospheric conditions (air pressure, humidity and temperature).
- Finally, the rider himself must make a test-run and check his machine for conditions (pick-up of engine speed, road surface conditions) and for the discoloration of the spark plug(s). After taking these into consideration, he must select the best possible carburetor settings.

TIP

It is advisable to make a note of settings, atmospheric conditions, road surface condition, lap-time, etc. so that the memorandum can be used as a reference useful for future.

ATMOSPHERIC CONDITIONS AND CARBURETOR SETTINGS

Air temp.	Humidity	Air pressure (altitude)	Mixture	Setting
High	High	Low (high)	Richer	Leaner
Low	Low	High (low)	Leaner	Richer

TIP

The reason for the above tendency is that the richness or leanness of a fuel mixture depends on the density of the air (i.e. the concentration of oxygen in it).

- Higher temperature expands the air with its resultant reduced density.
- Higher humidity reduces the amount of oxygen in the air by so much of the water vapor in the same air.
- Lower atmospheric pressure (at a high altitude) reduces the density of the air.

TEST RUN

After warming up the engine equipped with the standard type carburetor(s) and spark plug(s), run two or three laps of the circuit and check the smooth operation of the engine and discoloration of spark plug(s).

Discoloration	Condition of spark plug
Normal	Insulator is dry and burnt brown.
Over burned (too lean)	Insulator is whitish.
Oil fouled (too rich)	Insulator is sooty and wet.



- A. Normal
- B. Over burned (too lean)
- C. Oil fouled (too rich)

EFFECT OF SETTING PARTS IN RELATION TO THROTTLE VALVE OPENING

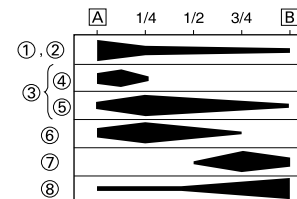
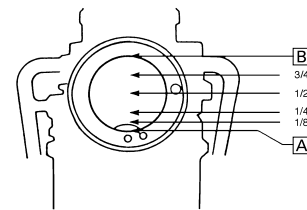

TIP

The power jet closes at 8,500 rpm of the engine, after which only the main jet dominates.

- A. Closed
- B. Full-open
- 1. Pilot jet
- 2. Pilot air screw
- 3. Jet needle
- 4. Diameter of straight portion
- 5. Clip position
- 6. Throttle valve
- 7. Power jet
- 8. Main jet

ADJUSTING THE MAIN JET

The richness of air-fuel mixture with 3/4–4/4 throttle can be set by changing the main jet "1".

Standard main jet	#178 *#180
-------------------	---------------

* Except for USA and CDN

1. Spark plug is too hot.
 - Select a main jet having higher calibrating No. than standard. (To be enriched)
2. Spark plug is wet.
 - Select a main jet having lower calibrating No. than standard. (To be leaned out)

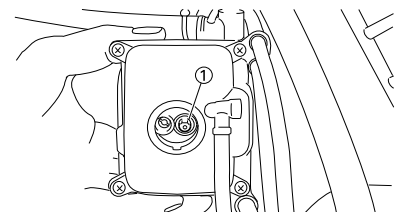

ADJUSTING THE POWER JET

The richness of air-fuel mixture under 8,500 rpm to the extent of 1/2 to full opened throttle can be set by changing the power jet "1". A larger size jet results in a richer mixture, and a smaller size in a leaner mixture.

Standard power jet	#50
---------------------------	------------

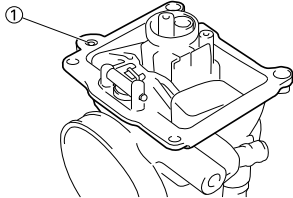

ADJUSTING THE PILOT AIR SCREW

The richness of the air-fuel mixture with full closed to 1/8 throttle can be set by turning the pilot air screw "1". Turning in the pilot air screw will enrich the mixture at low speeds, and turning out it will lean out the mixture.

Standard pilot air screw position	1-1/4 turns out * 2-1/4 turns out (for reference only)
--	---

* Except for USA and CDN

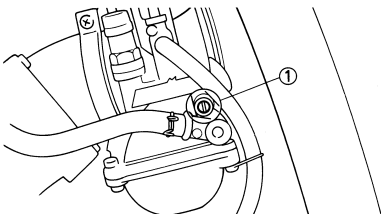

ADJUSTING THE PILOT JET

The richness of air-fuel mixture with the throttle fully closed to 1/2 open can be set by changing the pilot jet "1". It is changed when adjustment cannot be made by the pilot air screw alone.

Standard pilot jet	#50 *#52
---------------------------	---------------------------

* Except for USA and CDN

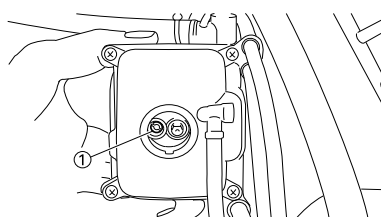

ADJUSTING THE JET NEEDLE GROOVE POSITION

Should the engine be hard to run smoothly at intermediate speeds, the jet needle "1" must be adjusted. If the mixture is too rich or too lean at intermediate speed operation, irregular engine operation and poor acceleration will result. Whether or not the richness of the mixture is proper is hard to be determined by means of the spark plug and therefore, it should be judged from your feeling of actual engine operation.

- Too rich at intermediate speeds
 - Rough engine operation is felt and the engine will not pick up speed smoothly.

In this case, step up the jet needle clip by one groove and move down the needle to lean out the mixture.
- Too lean at intermediate speeds
 - The engine breathes hard and will not pick up speed quickly.

Step up the jet needle clip by one groove and move up the needle to enrich the mixture.

Standard clip position	No.2 groove *No.3 groove
-------------------------------	---

*Except for USA and CDN

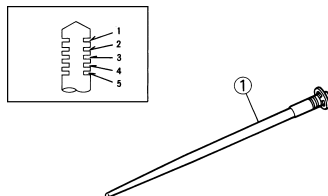

ADJUSTING THE JET NEEDLE

On the carburetors used in the YZ250, the main nozzle is press-fitted, so it can not be replaced. Therefore, carburetor setting requires the change of the jet needle.

- The jet needle setting parts, having the same taper angle, are available in different straight portion diameters and in different taper starting positions.

Standard jet needle	N3EW
----------------------------	-------------

- Difference in straight portion diameter.
- Difference in taper starting position
 - Diameter of the straight portion
 - Taper starting position
 - Rich
 - Lean

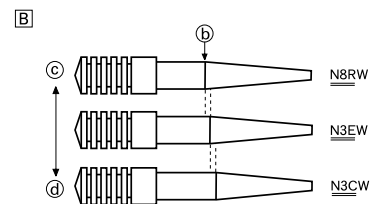
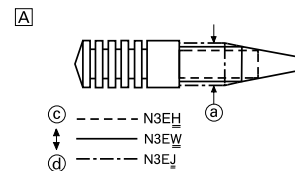

- Effects of changing the jet needle (reference)
 - Diameter of straight portion
Changing the diameter of the straight portion adjusts the air-fuel mixture when the throttle is 1/8 to 1/4 open.

- Taper starting position
Changing the taper starting position produces the same effect as changing the clip position by 0.5 groove.

<Example>

In case of being 0.5 groove leaner in relation to N3EW-3rd groove, choose N3CW-3rd groove.

- In case of being 0.5 groove leaner in relation to N3EW-3rd groove.
 - Difference of 0.5 groove

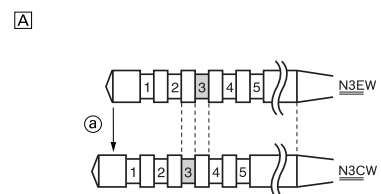

RELATIONSHIP WITH THROTTLE OPENING

The flow of the fuel through the carburetor main system is controlled by the main jet and then, it is further regulated by the area between the main nozzle and the jet needle. On the relationship between the fuel flow and the throttle opening, the fuel flow relates to the jet needle straight portion diameter around 1/8 to 1/4 throttle opening, whereas around 1/4 to 1/1 throttle opening it relates to the taper starting position and to the clip position.

Therefore, the fuel flow is balanced at each stage of throttle opening by the combination of the jet needle straight portion diameter, taper starting position and clip position.

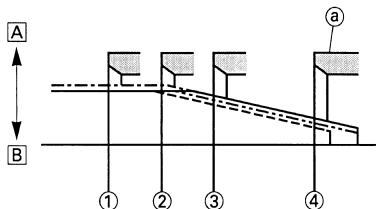

<Example>

—— N3EW-3 - - - - N3EJ-3
 - - - - N3EW-4 - - - - N8RW-3

- A. Lean (larger diameter)
- B. Rich (smaller diameter)
- 1. 1/8 throttle
- 2. 1/4 throttle
- 3. 1/2 throttle
- 4. 1/1 throttle
- a. Main nozzle

CARBURETOR SETTING PARTS

Main jet "1"	Size	Part number (-14943-)	
Rich	#190	4MX-45	
	#188	4MX-95	
	#185	4MX-44	
	#182	4MX-94	
	*(STD)	#180	4MX-43
	(STD)	#178	4MX-93
	#175	4MX-42	
	#172	4MX-92	
	#170	4MX-41	
	#168	4MX-91	
Lean	#165	4MX-40	
	#162	4MX-90	
	Pilot jet "2"	Size	Part number (-14948-)
	Rich	#62	4MX-12
#60		4MX-11	
#58		4MX-10	
#55		4MX-09	
*(STD)		#52	4MX-08
(STD)		#50	4MX-07
#48		4MX-06	
#45		4MX-05	
#42		4MX-04	
#40		4MX-03	
Lean	#38	4MX-02	

* Except for USA and CDN

Jet needle "3"	Size	Part number (-14916-)	
Rich	N8RH	4SR-RH	
	N3EH	4SR-EH	
	N8RW	4SR-RW	
	(STD)	N3EW	4SR-EW
	N3CW	4SR-CW	
	N3EJ	4SR-EJ	
Lean	N3CJ	4SR-CJ	
Powerjet "4"	Size	Part number (-1494F-)	
Rich	#65	4JT-13	
	#60	4JT-11	
	#55	4JT-09	
	(STD)	#50	4JT-07
Lean	#40	4JT-03	

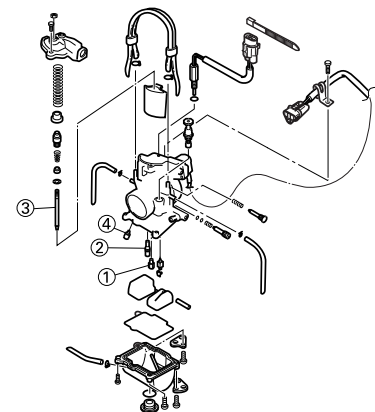

ROAD CONDITION AND EXAMPLES OF CARBURETOR SETTING

		General condition			Sandy condition		
		Under 10°C (50°F) (Winter)	15–25°C (59– 77°F) (Spring, Au- tumn)	Over 25°C (77°F) (Summer)	Under 10°C (50°F) (Winter)	15–25°C (59– 77°F) (Spring, Au- tumn)	Over 25°C (77°F) (Summer)
Main jet	A	#178	#178	#178	#182	#180	#178
	B	#180	#178	#178	#182	#180	#178
Jet needle	A	N3CW-3	N3EW-2	N3EJ-2	N3CW-3	N3CW-3	N3CW-3
	B	N3EW-3	N3CW-3	N3EW-2	N3CW-4	N3EW-3	N3EW-3
Pilot jet		#50	#50	#50	#52	#52	#52
Pilot air screw	A	-1/4	0	0	0	0	+1/4
	B	-1/4	0	0	-1/4	0	+1/4
Power jet		#50	#50	#50	#50	#50	#50

A. For USA and CDN

B. Except for USA and CDN

TIP

Optimum pilot air screw setting can be obtained by adding the ex-factory number of the same screw back-out turns to any required value provided in the chart. For example, if the ex-factory number is "1", add "1" to the value chosen in the chart.

EXAMPLES OF CARBURETOR SETTING DEPENDING ON SYMPTOM

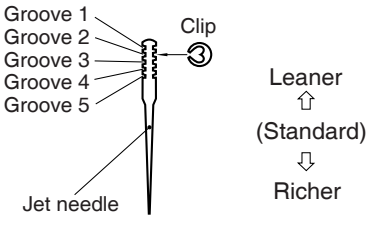
Symptom	Setting	Checking
At full throttle Hard breathing Shearing noise Whitish spark plug ↓ Lean mixture	Increase main jet calibration no. (Gradually)	Discoloration of spark plug → If tan color, it is in good condition. If cannot be corrected: Clogged float valve seat Clogged fuel hose Clogged fuel cock
At full throttle Stop of speed pick-up Slow speed pick-up Slow response Sooty spark plug ↓ Rich mixture	Decrease main jet calibration no. (Gradually) *In case of racing slight enrichment of mixture reduces engine trouble.	Discoloration of spark plug → If tan color, it is in good condition. If not effect: Clogged air filter Fuel overflow from carburetor
Lean mixture	Lower jet needle clip position. (1 groove down)	
Rich mixture	Raise jet needle clip position. (1 groove up)	
1/4–3/4 throttle Hard breathing Lack of speed	Lower jet needle clip position. (1 groove down)	
1/4–1/2 throttle Slow speed pick-up White smoke Poor acceleration	Raise jet needle clip position. (1 groove up)	
0–1/4 throttle Hard breathing Speed down	Use jet needle having a smaller diameter.	
0–1/4 throttle Hard breathing Speed down	Use jet needle having a smaller diameter.	Number of turns-back → Correct properly Overflow from carburetor
0–1/4 throttle Poor acceleration White smoke	Use jet needle with a larger diameter.	
Unstable at low speeds Pinking noise	Lower jet needle clip position. (1 groove down) Turn in pilot air screw.	
Poor response at extremely low speed	Reduce pilot jet calibration No. Turn out pilot air screw. If not effect, reverse the above procedures.	Dragging brake Overflow from carburetor
Poor response in the range of low to intermediate speeds	Raise jet needle clip position. If no effect, reverse the above procedures.	
Poor response when throttle is opened quickly	Check overall settings. Use main jet having lower calibration no. Raise jet needle clip position. (1 groove up) If no effect, reverse the above procedures.	Check air filter for fouling.
Poor engine operation	Turn in pilot air screw.	Check throttle valve operation.

TIP

This should be taken simply for an example. It is necessary to set the carburetor while checking the operating conditions of the engine and discoloration of spark plugs. Normally, carburetor setting is made by means of the main jet, needle clip position, pilot jet and pilot air screw. If the result of setting is still unsatisfactory, it is advisable to change the sizes of the jet needle.

CHANGE OF THE HEAT RANGE OF SPARK PLUGS

Judging from the discoloration of spark plugs, if they are found improper, it can be corrected by the following two methods; changing carburetor settings and changing the heat range of spark plug.

Standard spark plug	BR8EG/NGK (resistance type)
---------------------	-----------------------------

TIP

- In principle, it is advisable to first use spark plugs of standard heat range, and judging from the discoloration of spark plugs, adjust carburetor settings.
- If the calibration No. of the main jet must be changed by ± 15 , it is advisable to change the heat range of spark plugs and newly select the proper main jet.
- When checking the discoloration of spark plugs, be sure to stop the engine immediately after a run and check.
- Avoid racing.
- When changing the heat range of spark plugs, never attempt to change it more than ± 1 rank.
- When using a spark plug other than standard, check its heat range against the standard and check that it is a resistance type.
- Note that even if the discoloration seems proper, it may slightly vary with the spark plug maker and oil in use.

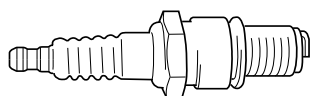

CHASSIS

SELECTION OF THE SECONDARY REDUCTION RATIO (SPROCKET)

Secondary reduction ratio =
Number of rear wheel sprocket teeth/Number of drive sprocket teeth

Standard secondary reduction ratio	3.571 (50/14)
------------------------------------	---------------

<Requirement for selection of secondary gear reduction ratio>

- It is generally said that the secondary gear ratio should be reduced for a longer straight portion of a speed course and should be increased for a course with many corners. Actually, however, as the speed depends on the ground condition of the day of the race, be sure to run through the circuit to set the machine suitable for the entire course.
- In actuality, it is very difficult to achieve settings suitable for the entire course and some settings may be sacrificed. Thus, the settings should be matched to the portion of the course that has the greatest effect on the race result. In such a case, run through the entire course while making notes of lap times to find the best balance; then, determine the secondary reduction ratio.
- If a course has a long straight portion where a machine can run at maximum speed, the machine is generally set such that it can develop its maximum revolutions toward the end of the straight line, with care taken to avoid the engine over-revving.

TIP

Riding technique varies from rider to rider and the performance of a machine also vary from machine to machine. Therefore, do not imitate other rider's settings from the beginning but choose your own setting according to the level of your riding technique.

DRIVE AND REAR WHEEL SPROCKETS SETTING PARTS

Part name	Size	Part number
Drive sprocket "1"	13T	9383E-13216
	(STD) 14T	9383E-14215
Rear wheel sprocket "2"	47T	17D-25447-50
	48T	17D-25448-50
	49T	17D-25449-50
	(STD) 50T	17D-25450-50
	51T	17D-25451-50
	52T	17D-25452-50

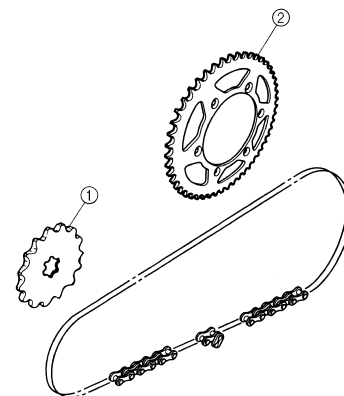

TIRE PRESSURE

Tire pressure should be adjusted to suit the road surface condition of the circuit.

	Standard tire pressure: 100 kPa (1.00 kgf/cm ² , 15 psi)
--	---

- Under a rainy, muddy, sandy, or slippery condition, the tire pressure should be lower for a larger area of contact with the road surface.

	Extent of adjustment: 60–80 kPa (0.60–0.80 kgf/cm ² , 9.0–12 psi)
--	--

- Under a stony or hard road condition, the tire pressure should be higher to prevent a flat tire.

	Extent of adjustment: 100–120 kPa (1.00–1.20 kgf/cm ² , 15–18 psi)
--	---

FRONT FORK SETTING

The front fork setting should be made depending on the rider's feeling of an actual run and the circuit conditions. The front fork setting includes the following three factors:

1. Setting of air spring characteristics
 - Change the fork oil amount.
2. Setting of spring preload
 - Change the spring.
3. Setting of damping force
 - Change the compression damping.
 - Change the rebound damping.

The spring acts on the load and the damping force acts on the cushion travel speed.

CHANGE IN AMOUNT AND CHARACTERISTICS OF FORK OIL

Damping characteristic near the final stroke can be changed by changing the fork oil amount.

⚠ WARNING

Adjust the oil amount in 5 cm³ (0.2 Imp oz, 0.2 US oz) increments or decrements. Too small oil amount causes the front fork to produce a noise at full rebound or the rider to feel some pressure on his hands or body. Alternatively, too large oil amount will cause the air spring characteristics to have a tendency to be stiffer with the consequent deteriorated performance and characteristics. Therefore, adjust the front fork within the specified range.



Standard oil amount:
320 cm³ (11.3 Imp oz, 10.8 US oz)
Extent of adjustment:
300–365 cm³ (10.6–12.9 Imp oz, 10.1–12.3 US oz)

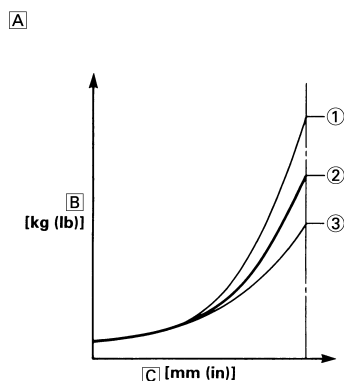

- A. Air spring characteristics in relation to oil amount change
 B. Load
 C. Stroke
1. Max. oil amount
 2. Standard oil amount
 3. Min. oil amount

SETTING OF SPRING AFTER REPLACEMENT

As the front fork setting can be easily affected by rear suspension, take care so that the machine front and rear are balanced (in position, etc.) when setting the front fork.

1. Use of soft spring
 - Change the rebound damping. Turn out one or two clicks.
 - Change the compression damping. Turn in one or two clicks.

TIP

Generally a soft spring gives a soft riding feeling. Rebound damping tends to become stronger and the front fork may sink deeply over a series of gaps.

2. Use of stiff spring
 - Change the rebound damping. Turn in one or two clicks.
 - Change the compression damping. Turn out one or two clicks.

TIP

Generally a stiff spring gives a stiff riding feeling. Rebound damping tends to become weaker, resulting in lack of a sense of contact with the road surface or in a vibrating handlebar.

FRONT FORK SETTING PARTS

- Front fork spring "1"

TYPE	SPRING RATE	SPRING PART NUMBER (-23141-)	I.D. MARK (slits)
SOFT	0.398	1C3-A1	
	0.408	1C3-B1	
	0.418	1C3-C1	
	0.428	1C3-D1	
STD	0.438	5XC-M1	—
STIFF	0.449	1C3-F1	-
	0.459	1C3-G1	-
	0.469	1C3-H1	-
	0.479	1C3-J1	-

TIP

The I.D. mark (slits) "a" is proved on the end of the spring.

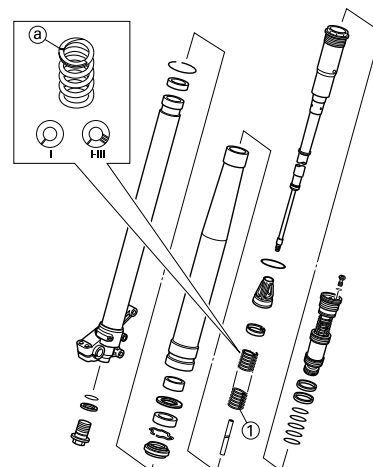

REAR SUSPENSION SETTING

The rear suspension setting should be made depending on the rider's feeling of an actual run and the circuit conditions.

The rear suspension setting includes the following two factors:

1. Setting of spring preload
 - Change the set length of the spring.
 - Change the spring.
2. Setting of damping force
 - Change the rebound damping.
 - Change the compression damping.

CHOOSING SET LENGTH

- Place a stand or block under the engine to put the rear wheel above the floor, and measure the length "a" between the rear wheel axle center and the rear fender holding bolt.

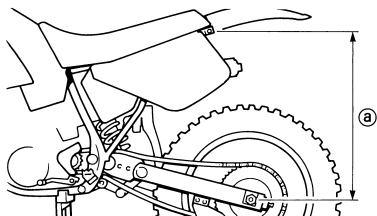

- Remove the stand or block from the engine and with a rider astride the seat, measure the sunken length "b" between the rear wheel axle center and the rear fender holding bolt.

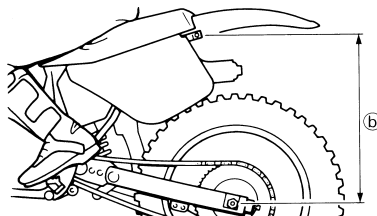

- Loosen the locknut "1" and make adjustment by turning the spring adjuster "2" to achieve the standard figure from the subtraction of the length "b" from the length "a".

Standard figure:
90–100 mm (3.5–3.9 in)

TIP

- If the machine is new and after it is broken in, the same set length of the spring may change because of the initial fatigue, etc. of the spring. Therefore, be sure to make reevaluation.
- If the standard figure cannot be achieved by adjusting the spring adjuster and changing the spring set length, replace the spring with an optional one and make readjustment.

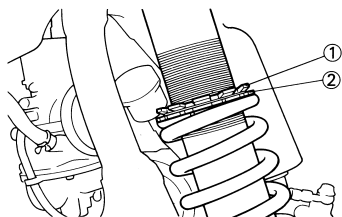

SETTING OF SPRING AFTER REPLACEMENT

After replacement, be sure to adjust the spring to the set length [sunken length 90–100 mm (3.5–3.9 in)] and set it.

- Use of soft spring
 - Set the soft spring for less rebound damping to compensate for its less spring load. Run with the rebound damping adjuster one or two clicks on the softer side and readjust it to suit your preference.
- Use of stiff spring
 - Set the soft spring for more rebound damping to compensate for its greater spring load. Run with the rebound damping adjuster one or two clicks on the stiffer side and readjust it to suit your preference.

TIP

Adjusting the rebound damping will be followed more or less by a change in the compression damping. For correction, turn the low compression damping adjuster on the softer side.

WARNING

When using a rear shock absorber other than currently installed, use the one whose overall length "a" does not exceed the standard as it may result in faulty performance. Never use one whose overall length is greater than standard.

Length "a" of standard shock:
490 mm (19.29 in)

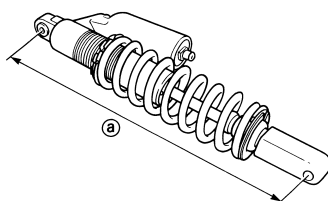

REAR SHOCK ABSORBER SETTING PARTS

- Rear shock spring "1"
- [Equal-pitch steel spring]

TYPE	SPRING RATE	SPRING PART NUMBER (-22212-)	I.D. MARK/Q'TY
SOFT	4.3	5UN-00	Brown/1
	4.4	5UN-10	Green/1
	4.7	5UN-20	Red/1
STD	4.9	5UN-30	Black/1
STIFF	5.1	5UN-40	Blue/1
	5.3	5UN-50	Yellow/1
	5.5	5UN-60	Pink/1
	5.7	5UN-70	White/1

[Unequal-pitch steel spring]

TYPE	SPRING RATE (approx.)	SPRING PART NUMBER (-22212-)	I.D. MARK/Q'TY
SOFT	4.5	5UN-A0	Green/2
	4.7	5UN-B0	Red/2
	4.9	5UN-C0	Black/2
	5.1	5UN-D0	Blue/2
	5.3	5UN-E0	Yellow/2
STIFF	5.5	5UN-F0	Pink/2
	5.7	5UN-G0	White/2

TIP

- The unequal-pitch spring is softer in initial characteristic than the equal-pitch spring and is difficult to bottom out under full compression.
- The I.D. mark "a" is marked at the end of the spring.
- Spring specification varies according to the color and quantity of I.D. marks.

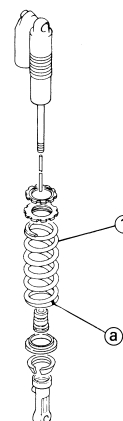

- Extent of adjustment (spring preload)

SPRING PART NUMBER (-22212-)	Maximum	Minimum
5UN-00 5UN-10 5UN-20 5UN-30 5UN-40 5UN-50 5UN-60 5UN-70 5UN-A0 5UN-B0 5UN-C0 5UN-D0 5UN-E0 5UN-F0 5UN-G0	Position in which the spring is turned in 18 mm (0.71 in) from its free length.	Position in which the spring is turned in 1.5 mm (0.06 in) from its free length.

TIP

For the spring preload adjustment, refer to "ADJUSTING THE REAR SHOCK ABSORBER SPRING PRELOAD" in the CHAPTER 3.

SUSPENSION SETTING (FRONT FORK)

TIP

- If any of the following symptoms is experienced with the standard position as the base, make resetting by reference to the adjustment procedure given in the same chart.
- Before any change, set the rear shock absorber sunken length to the standard figure 90–100 mm (3.5–3.9 in).

Symptom	Section				Check	Adjust
	Jump	Large gap	Medium gap	Small gap		
Stiff over entire range	○	○	○		Compression damping Oil amount Spring	Turn adjuster counterclockwise (about 2 clicks) to decrease damping. Decrease oil amount by about 5–10 cm ³ (0.2–0.4 Imp oz, 0.2–0.3 US oz). Replace with soft spring.
Unsmooth movement over entire range	○	○	○	○	Outer tube Inner tube Slide metal Piston metal Under bracket tightening torque	Check for any bends, dents, and other noticeable scars, etc. If any, replace affected parts. Replace with a new one for extended use. Replace with a new one for extended use. Retighten to specified torque.
Poor initial movement				○	Rebound damping Oil seal	Turn adjuster counterclockwise (about 2 clicks) to decrease damping. Apply grease in oil seal wall.
Soft over entire range, bottoming out	○	○			Compression damping Oil amount Spring	Turn adjuster clockwise (about 2 clicks) to increase damping. Increase oil amount by about 5–10 cm ³ (0.2–0.4 Imp oz, 0.2–0.3 US oz). Replace with stiff spring.
Stiff toward stroke end	○				Oil amount	Decrease oil amount by about 5 cm ³ (0.2 Imp oz, 0.2 US oz).
Soft toward stroke end, bottoming out	○				Oil amount	Increase oil amount by about 5 cm ³ (0.2 Imp oz, 0.2 US oz).
Stiff initial movement	○	○	○	○	Compression damping	Turn adjuster counterclockwise (about 2 clicks) to decrease damping.
Low front, tending to lower front posture			○	○	Compression damping Rebound damping Balance with rear end Oil amount	Turn adjuster clockwise (about 2 clicks) to increase damping. Turn adjuster counterclockwise (about 2 clicks) to decrease damping. Set sunken length for 95–100 mm (3.7–3.9 in) when one passenger is astride seat (lower rear posture). Increase oil amount by about 5 cm ³ (0.2 Imp oz, 0.2 US oz).
"Obtrusive" front, tending to upper front posture			○	○	Compression damping Balance with rear end Spring Oil amount	Turn adjuster counterclockwise (about 2 clicks) to decrease damping. Set sunken length for 90–95 mm (3.5–3.7 in) when one passenger is astride seat (upper rear posture). Replace with soft spring. Decrease oil amount by about 5–10 cm ³ (0.2–0.4 Imp oz, 0.2–0.3 US oz).

SUSPENSION SETTING (REAR SHOCK ABSORBER)

TIP

- If any of the following symptoms is experienced with the standard position as the base, make resetting by reference to the adjustment procedure given in the same chart.
- Adjust the rebound damping in 2-click increments or decrements.
- Adjust the low compression damping in 1-click increments or decrements.
- Adjust the high compression damping in 1/6 turn increments or decrements.

Symptom	Section				Check	Adjust
	Jump	Large gap	Medium gap	Small gap		
Stiff, tending to sink			○	○	Rebound damping Spring set length	Turn adjuster counterclockwise (about 2 clicks) to decrease damping. Set sunken length for 90–100 mm (3.5–3.9 in) when one passenger is astride seat.
Spongy and unstable			○	○	Rebound damping Low compression damping Spring	Turn adjuster clockwise (about 2 clicks) to increase damping. Turn adjuster clockwise (about 1 click) to increase damping. Replace with stiff spring.
Heavy and dragging			○	○	Rebound damping Spring	Turn adjuster counterclockwise (about 2 clicks) to decrease damping. Replace with soft spring.
Poor road gripping				○	Rebound damping Low compression damping High compression damping Spring set length Spring	Turn adjuster counterclockwise (about 2 clicks) to decrease damping. Turn adjuster clockwise (about 1 clicks) to increase damping. Turn adjuster clockwise (about 1/6 turn) to increase damping. Set sunken length for 90–100 mm (3.5–3.9 in) when one passenger is astride seat. Replace with soft spring.
Bottoming out	○	○			High compression damping Spring set length Spring	Turn adjuster clockwise (about 1/6 turn) to increase damping. Set sunken length for 90–100 mm (3.5–3.9 in) when one passenger is astride seat. Replace with stiff spring.
Bouncing	○	○			Rebound damping Spring	Turn adjuster clockwise (about 2 clicks) to increase damping. Replace with soft spring.
Stiff travel	○	○			High compression damping Spring set length Spring	Turn adjuster counterclockwise (about 1/6 turn) to decrease damping. Set sunken length for 90–100 mm (3.5–3.9 in) when one passenger is astride seat. Replace with soft spring.

